

THE NEW
BIBLIOTHECA ALEXANDRINA
REFLECTIONS ON A JOURNEY OF ACHIEVEMENTS

Mohsen Zahran



2007

In the Name of God, the Merciful, the Compassionate

"God is the light of the heavens and the earth..."

Holy Quran, 24:35

"And (God) saith: Be and it is"

Holy Quran, 2:117; 19:35

"And God said let there be light and there was light"

The Old Testament, Genesis 1:3

Bibliotheca Alexandrina Cataloging-in-Publication Data

Zahrān, Muḥsin Muḥarram.

The new Bibliotheca Alexandrina : reflections on a journey of achievements / Mohsen Zahran. – Alexandria, Egypt : Bibliotheca Alexandrina, 2007.

p. cm.

ISBN 978-977-6163-92-8

1. Bibliotheca Alexandrina. 2. Libraries -- Egypt -- Alexandria -- History -- To 400. 3. Library planning -- Egypt -- Alexandria. 4. Library architecture -- Competitions -- Egypt -- Alexandria. I. Title.

027.0621--dc21

2007346545

Dar ElKuttub Depository No. 21710/2007

ISBN 978-977-6163-92-8

© 2007, Bibliotheca Alexandrina. All rights reserved.

NON-COMMERCIAL REPRODUCTION

Information in this publication has been produced with the intent that it be readily available for personal and public non-commercial use and may be reproduced, in part or in whole and by any means, without charge or further permission from the Bibliotheca Alexandrina. We ask only that:

- Users exercise due diligence in ensuring the accuracy of the materials reproduced;
- Bibliotheca Alexandrina be identified as the source; and
- The reproduction is not represented as an official version of the materials reproduced, nor as having been made in affiliation with or with the endorsement of the Bibliotheca Alexandrina.

COMMERCIAL REPRODUCTION

Reproduction of multiple copies of materials in this publication, in whole or in part, for the purposes of commercial redistribution is prohibited except with written permission from the Bibliotheca Alexandrina. To obtain permission to reproduce materials in this publication for commercial purposes, please contact the Bibliotheca Alexandrina, P.O. Box 138, Chatby, Alexandria 21526, Egypt. E-mail: secretariat@bibalex.org

The information in this publication is solely the responsibility of the author.

1000 Copies

C o n t e n t s

- Foreword by Ismail Serageldin 9
- Prologue 11
- Chapter 1: The Ancient Library of Alexandria 14
- Chapter 2: Historical Dimensions: The Birth of the Revival Idea and National Support 20
- Chapter 3: International Community Involvement and National Commitment 40
- Chapter 4: International Architectural Competition 50
- Chapter 5: The Aswan Meeting of the International Commission 68
- Chapter 6: The Torch Carriers: The General Organization of the Alexandria Library and the Executive Secretariat 76
- Chapter 7: Architectural Conception and Realization 88
- Chapter 8: The Implementation Process 104
- Chapter 9: International Contributions and Support of the Friends Associations 138
- Chapter 10: The Intellectual Content and Development of Human Resources 154
- Chapter 11: Future Outlook: Promises and Horizons 172
- Chapter 12: Reminiscences; The Human Dimensions: Flashes of Indelible Memories 180
- Epilogue 192
- Appendices 198
- Index 304



“ Egypt has initiated the idea of reviving the Alexandria Library because it believes that not on bread alone does man live, but that culture is the food of thought, conscience and feelings, and this is of no less importance to man than his material needs.*”*

H.E. Mohammed Hosni Mubarak,
President of the Arab Republic of Egypt



“ We are here to build a library complex that would not only work to preserve civilization’s memory and humanity’s legacy for future generations, but also, to contribute to the expansion of our collective knowledge.*”*

H.E. Mrs. Suzanne Mubarak

Foreword

It is a pleasure to present this publication by Dr. Mohsen Zahran to the public. Dr. Zahran has devoted a large part of his life to bringing the dream of building the New Library of Alexandria to reality. He was there at the initial call by Dr. El-Abbadi over three decades ago, and he was one of the most forceful advocates of implementing the project. In 1988, Dr. Zahran became the Director of the project after it became a national priority program with its own organization: the General Organization for Alexandria Library (GOAL). He was involved in preparing the detailed program for the project, in organizing the international competition with UNESCO and IUA, and he was a member of the Jury that selected the winning design. He was there at the Aswan meeting that launched the International Honorary Commission chaired by H.E. Mrs. Suzanne Mubarak, and the subsequent steps for the start-up of implementation.

Dr. Zahran, then oversaw the agreements with the consultants Snohetta/Hamza and the bidding process. He also built up a team to become the nucleus of implementation of the project. He was involved with every step and every aspect of the preparation and implementation of this award winning building. No detail was too small to escape his attention, and no challenge was too large to be taken on. He gave of himself without reservation. The magnificent building we now have is a legacy that he and all of us can be proud of. He retired as the building was inaugurated to the public in 2002.

He joined us in celebrating the recognition of the Building by the Aga Khan Award for Architecture in 2004.

Dr. Zahran's story is one that deserves to be told. It is the story of a vision and the dedicated pursuit of its translation into reality. It is a record of achievement and of challenges overcome, a record of a dedicated professional who gave of himself to realize a national dream. It is also a record of a particular and very important aspect of the birth of the New Library of Alexandria.

Thus, I was delighted when he accepted my invitation to record, for posterity, his experience, and this publication is the outcome. It is particularly appropriate that the publication should come out now, on the occasion of the Fifth Anniversary of the Bibliotheca Alexandrina.

I thank him for his efforts, and invite all the readers to enjoy the publication and the journey that it recounts.

Ismail Serageldin

PROLOGUE



Planetarium, Bridge and Plaza of Civilizations

This book has been prepared upon the kind request of the Director of the Bibliotheca Alexandrina, Dr. Ismail Serageldin. It tells the story of the birth and implementation of the New Bibliotheca Alexandrina, during the past sixteen years of my personal association with the Project as Director of the General Organization of the Alexandria Library (GOAL) and Manager of the unique Bibliotheca Alexandrina Project.

I have devoted the past few months to compile all relevant information, record my reflections, contact various personalities with whom I have worked and collaborated to achieve the Revival of the Library of Alexandria, a lighthouse of knowledge. This beacon of enlightenment targets the advancement of human civilization and the pursuit of excellence, which was the universally recognized achievement of its famous predecessor.

This commemorative volume brings together the long process of the main phases of development, the statements, and speeches, involved with the Project, that had the full support of Egypt, UNESCO, UNDP, and nations from all the world.

The Ancient Library was truly international in its own time and was considered the eighth wonder of the ancient world. The New Library would need to call on extraordinary resources, both financial and technical, to achieve in a modern sense, what the ancient one had demonstrated. The mission of the Ancient Library as a university of unique scholarship and international dialogue, and the fruits of the works and ideas of its scholars, have become the basis of our present world civilization. This seed of ingenuity and excellence has become a continuum which inspired scholars everywhere, to become devoted to its revival, almost at the same site in Alexandria, to ensure the continuity of its mission as a forum of dialogue and cooperation among civilizations.

The hard ingenious work of design, construction and execution is highlighted in this book. Many facets and aspects of innovative technological breakthroughs and accomplishments have been realized through the unique collaboration and commitment of the institutions involved, locally and internationally, including the consultants and the contractors.

The New Bibliotheca Alexandrina will also inform future generations that we, irrespective of color, creed or national origin, are not only content to receive, preserve and foster the knowledge inherited from our forefathers, but that we have also followed their example by leaving them a valuable legacy of knowledge. Upon this knowledge they will build and initiate even greater achievements and triumphs of human mind and spirit. The message torch will continue its brilliance and advancement as before, for a better future for all mankind.

The book finally underscores the horizons, vistas, roles, frontiers, and impact of the rising sun of the New Bibliotheca Alexandrina, not only on the city of Alexandria, one of the oldest planned existing cities of the world, but also on the Middle East, Africa, the Mediterranean basin and the world at large.

The Egyptian authorities had a true sense of vision decades ago when they were beginning a comprehensive socio-economic development and the renewal of Egypt's infrastructure and urbanization drive concomitantly with the conservation of cultural heritage. They included the Bibliotheca Alexandrina in their plans to institute needed cultural, intellectual and scientific development in parallel with physical development plans.

It was before the advent of the Internet that the New Library plans embodied the inclusive recommendations of technological revolutions, envisioning the current global cyberspace communication system. Furthermore, by placing the Library under the auspices of H.E. President Hosni Mubarak and H.E. Mrs. Suzanne Mubarak, the Project gained both national and international prominence and importance.

I am very proud to have been able, as the Executive Director and Project Manager, to play a challenging role in this extraordinary Project to bring knowledge, culture and the pursuit of peace to Egypt, the Mediterranean Region and beyond.

Mohsen Zahran

Former Executive Director of GOAL and Project Manager



“Through the written word, the past becomes part of the present, and the present becomes history.”

UNESCO Promotion video, narrated by Omar Sherif

CHAPTER 1

THE ANCIENT LIBRARY
OF ALEXANDRIA

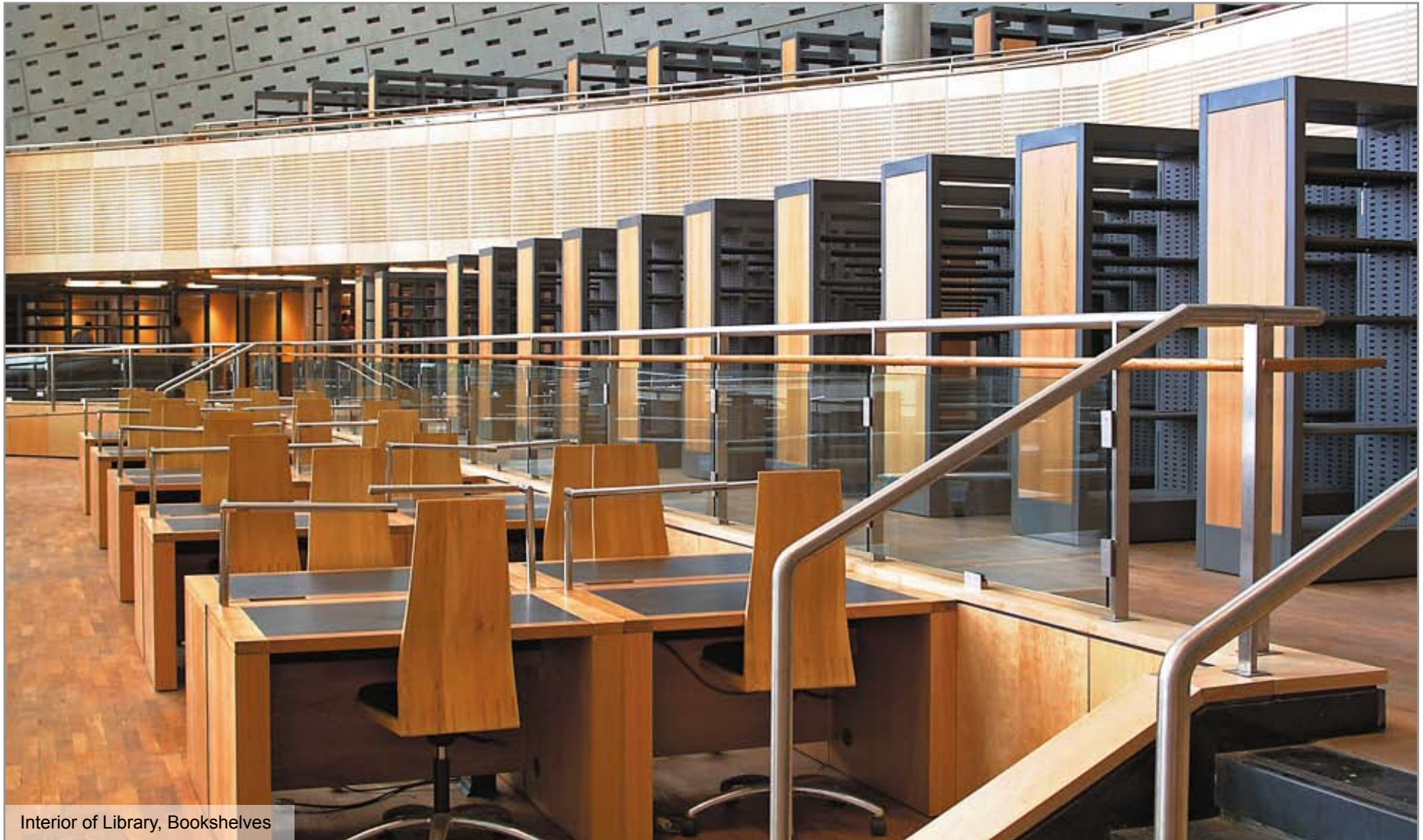

Interior of Library, Bookshelves

In 1988, during the ceremony for laying the cornerstone, the Egyptian Government in cooperation with UNESCO announced plans to “revive the Ancient Bibliotheca Alexandrina by restating its universal legacy in modern terms”. The objective was not to assemble the original collections of works likely to have been contained in the Ptolemaic Library, since it is known that there are almost no original works remaining. The goal was the revival, not the recreation, of the ancient institution as a “temple of learning”. Its focus is mainly the pursuit of excellence in knowledge, in the history, geography and culture of the Mediterranean world and the Near East.

The achievements realized in this Project testify to the fact that Egypt, a developing country facing its more than usual burden of problems of socio-economic and cultural development, was dedicated to

rebuilding the New Bibliotheca Alexandrina. The basic objective was not only the direct benefit for its exploding population, but also for the welfare of people in the region and around the world.

The Ancient Library of Alexandria opened its doors to every person who sought knowledge without any discrimination due to color, origin or religion. At this early juncture of human history, this was an expression of the equality of human beings in knowledge. Moreover, as the Egyptian President Mohamed Hosni Mubarak, declared in his Speech in Aswan, the Revival of the Library of Alexandria is a global cultural event, not exclusive to Egypt alone. He further asserted that “Egypt has initiated the idea of the Revival of the Bibliotheca Alexandrina, because it believes that not on bread alone does man live, but that culture is the food of thought, conscience and feelings....”

Egypt, as one of the world’s most ancient civilizations is aware of its cultural role and the duties imposed upon it by its geographic location, historical background and cultural heritage. “Egypt builds with one hand, and develops its civilization with the other”, pointed out President Mubarak in the International Meeting of Aswan.

In Alexandria, where now nearly four million people live, lies buried the stones of the famous Library that flourished during Egypt’s Ptolemaic dynasty of Greek rulers, and nearly four centuries of Roman rulers. Over 2300 years ago, at the peak of his glory, Alexander the Great founded this city on the shores of Egypt. Greek influence was dominant, imposed mainly by the dynasty that descended from Lagus, who seized power upon Alexander's death in 323 BCE. He later crowned himself king and became Ptolemy I Soter, who reigned until 284 BCE. Most of the city’s population was Greek. Nevertheless, a strong Egyptian contingent grew there, and remained in the nearby village of Rakotis.

Ptolemy I Soter and his son Ptolemy II Philadelphus (285-246 BCE) were determined not only to make Egypt independent of the other parts of Alexander's empire but also to give it the splendor of Greek culture. The Ptolemies succeeded at this by importing Greek learning, and this cemented their Greek world together for centuries.

The Ancient Library was a public research library, a national library. It was a combination of two cultures, the Greek culture, which was a culture of the spoken word “Greek Paideia”, and what Egypt represented, a culture of the “written word” that had already existed for centuries and was kept carefully in the priesthood associated with the temples.



Ancient Library of Alexandria



Satellite View of Delta and Egypt



Coin: Ptolemy II and Wife

Alexandria's rise to glory in antiquity was no doubt due to the vital role the city and its Library played in the development of science and ideas. However, the works in the Library were not solely in Greek; the writings of other civilizations were also represented. Legend has it that 70 learned men were given the task of translating the Old Testament into Greek, hence the name *Septuagint* or “translation by the seventy”. Babylonian and Buddhist writings are also said to have formed part of the collection.

With its universal character, the Library played a major part in the development of the Greco-Roman civilization, on which Western culture is based.

The loss of the Ancient Library was one of the greatest disasters in the history of learning. The Revival of the Library overcomes and transcends this historic loss only to make a lasting contribution in the continuum of the goals and manifestations of the Bibliotheca Alexandrina.



Exterior of Library, Statue of Ptolemy II

Rebuilding the Library at Alexandria
Rebuilding the Library at Alexandria
Rediscovering common ground
Reclaiming what was lost as found
Rejoicing with a heart felt sound
At Alexandria Al Iskandaria Al Iskandaria
Reminding the human race we share a common goal
Rekindling the love of learning that makes us whole
Remaining true to high ideals
Retaining what the past reveals
Responding to the broad appeals
Oh Alexandria al Iskandaria Al Iskandaria
Renewing scholastic ties that once were strong
Realizing a modern dream to right an ancient wrong
Returning to the golden ages
Rewriting history's darker pages
Reviving respect for the sages
Of Alexandria al Iskandaria Al Iskandaria
A song dedicated to the Library of Alexandria, composed and sung
by Lewis Elbinger and Kinder (January 1990)



“ History teaches everything including the future. ”

Lamartine

CHAPTER 2

HISTORICAL DIMENSIONS: THE
BIRTH OF THE REVIVAL IDEA
AND NATIONAL SUPPORT



Planetarium and Bridge overlooking the Eastern Harbor

Egypt went through many phases during the past two millennia that reflect its significant historical influence, on the cultural symbols of the world. The history of Egypt is not of course detached from the history of Alexandria, but is an integral part of it with all its glories and declines, successes and failures, ups and downs.

Alexandria was the greatest and most lasting of Alexander the Great's numerous foundations in the various parts of his empire. Alexander chose the "Eastern Harbor" for his navy and planned his renowned city around its shores. Alexandria was the major port on the Mediterranean, the center of trade and the intellectual radiance of culture, economy, and activities of urban vitality. To this day it remains the pride of the Mediterranean and the principal harbor of Egypt.

Twenty-three hundred years ago in Alexandria, the proclamation of the order by Ptolemy I Soter, King of Egypt, was the genesis of the Library of Alexandria. The Library was regarded as the eighth wonder

of the ancient world and the first of the great libraries in Western history. Evidence for its history and collections, and for its disappearance, is conjectural and controversial.

Andrew G. Jameson ruminated upon the Ancient Library stating that the formation of libraries was an indication of civilized societies. He said that Egyptian temples were traditionally the main centers of learning and that Hecataeus of Abdera stated that priests taught children two kinds of writing, the “sacred” (hieroglyphic or hieratic) and the more “common” demotic script for general instruction. Temples were repositories of information and all or most temples had a library. The Ptolemies continued this practice, as did the Romans after them.

To attract men of learning the Ptolemies set up a temple of the Muses (Museion) in the Royal Palace in Alexandria (Brucheion) for the practice of the arts. The Museion included an observatory, zoological and botanical gardens, debating rooms and a library. Built by Ptolemy II Philadelphus on the model of the Aristotelian library, the Lyceum in Athens (where Aristotle, the teacher of Alexander and Ptolemy I Soter, had taught), the Museion grew rapidly thanks to the unremitting efforts of the kings of Egypt who gave it the status of a universal research institution.

Tradition has it that Ptolemy I Soter had acquired the library built up by Aristotle himself - one of the greatest collectors of antiquity. Demetrius of Phaleron, who was also a student of Aristotle, was invited by Ptolemy I Soter to advise him on cultural matters, especially the building of the New Library. His policies of acquisition are well known, for example works like the Greek tragedies were borrowed from Athens for a cash deposit, and were brought to Alexandria so that copies could be made, often several at a time. All manuscripts found on ships anchored in the port were temporarily impounded for as long as was necessary for them to be copied.

There is no firm evidence on how many papyrus scrolls were in the collection of the Library. One estimate dating from the first century BCE gives a figure of two-hundred-thousand. Other authors writing in ancient times go as high as seven-hundred-thousand.

Historians know that this was the first library whose contents were classified and listed in a catalog in accordance with the rules drawn up by Callimachus (305-240 BCE), the teacher of Eratosthenes and, via him, of Aristarchus. Both numbered among the early directors of the Library. Callimachus laid down the manner in which works should be described, often giving titles to those that had none, and indicating the number of lines in each. From this catalog he extracted a bibliography of all Greek



Demetrius of Phaleron

Quote in praise of Demetrius of Phaleron:

Though from an humble stock,
undoubtedly
was fashion'd too much honour
from his cradle.
He was a scholar, and a ripe and
good one; Exceeding wise, fair-
spoken and persuading:
Lofty and sour to them that loved
him not,
But to those men that sought him,
sweet a summer.
HY.VIII-4-2 Parsons

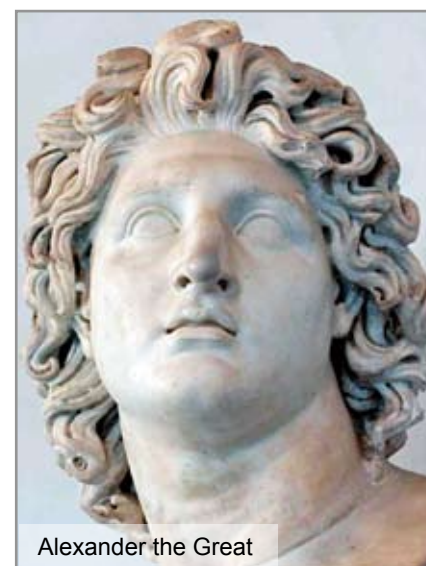

Alexander the Great



Euclid



Eratosthenes



Demetrius



Aristarchus



Demetrius



Archimedes

works known at the time, adding a biographical note alongside the author's name. The only knowledge we have of this catalog (Pinakes, i.e. tables or lists) is through quotations that appear in the classics. Of the Library's catalog, nothing has remained. Four or five scrolls from the third century CE contain fragments of a catalog or lists of works, and it is thought that some of these may have a connection with the Library. What is clear is that the method applied for the epigram quotations is that of Callimachus.

The greatest savants of the Hellenistic period (300 BCE - 300 CE) lived in Alexandria, drawn to it by the patronage and generosity of Egypt's rulers. Attached to the Museion or using the resources of the Library to back up their own discoveries, they created a powerful intellectual movement affecting every field of knowledge. Some of the most notable were Herophilos (*circa* 300 BCE) who drew up the rules of anatomy and physiology, Euclid (330-280 BCE) who invented geometry, Eratosthenes (284-192 BCE) who calculated the circumference of the Earth scientifically, Aristarchus (215-143 BCE) who believed that motions in the sky could be explained by the hypothesis that the Earth turns around its axis once every twenty-four hours besides many other discoveries; Dionysius of Thrace (170-90 BCE) who codified grammar, Hero (first century CE) who wrote several books on mechanics and automata and invented the dioptra; a surveying instrument later superseded by the theodolite and, finally, Claudius Ptolemy (90-168 CE), founder of the technique of map-making and author of a major work on astronomy. Thus, Alexandria "the Pride of the Mediterranean" has dazzled all who looked upon her. Two aspects gave the port of Alexandria such an imposing position.

- The first factor was the construction of the "Pharos" lighthouse by Stratos the Engineer, in the year 300 BCE on the orders of Ptolemy I Soter. The lighthouse was an imposing structure more than 135 meters high and the Seventh Wonder of the Ancient World.
- The second factor is the role of Egypt's capital and principal port during the Ptolemaic period.

"Walk on the path where the
carriages do not journey,
do not drive in the tracks of
others,
do not travel the broad way,
but on a road of your own,
even though it be a narrow
one."

Callimachus, *Aitia*, I, I, 25-28 Trypanis;
Palatine Anthology,
XII, 43,4

"Four are the graces now; and
all may see Another added to the former
three, Yet wet with unguents,
and but lately born;
Fair Berenice blooming as the
morn,
So bright with charms, and
such her beauteous face, That
robb'd of her the Graces lose
their grace."

Callimachus, *Epigrams*, LIV

Destruction of the Ancient Library

Alexandria, of all the Greek cities, was the most frequently racked by invasions and civil strife throughout history. It was inevitable that the Ancient Library would also suffer from these troubles. Who, when or what, was directly responsible for its ultimate destruction is still unknown, regardless of the many stories or accounts.

There are many legends about the Library's destruction. It is known that the Library was damaged by fire for the first time in 48 BCE during the siege of Alexandria by Julius Caesar, but whether this was a sabotage or an accident is not known. A few years later Antony had the Library of Pergamum (about two-hundred-thousand scrolls) transferred to Alexandria by way of compensation to Cleopatra.

Undoubtedly the replacement of the papyrus scroll by the codex – a set of pages bound together under a cover of wood or leather (like those discovered at Nag-Hammadi in 1945) and far more convenient to store and consult – in a way accounts for the fate of the Library. However, several historians attribute the disappearance of what remained to fire. It was such a tragic fate that none of those contributions survived.

- Edward Gibbon in *The Decline and Fall of the Roman Empire* blamed the Christians based on the theory that bigotry led to the fall of the Roman Empire.
- Professor Mostafa El-Abbadi, author of *The Life and Fate of the Alexandria Library*, blamed Julius Caesar for the fire in 48 CE in the Eastern Harbor.
- The Italian scholar, Prof. Luciano Canfora, blamed the Arabs when they conquered Egypt. However, it is important to mention that the Arabs were well known as lovers of books and knowledge throughout the centuries. The Arab translations of the Greek manuscripts and their own contributions to the advancement of human knowledge were conveyed to Europe through Andalusia, and thus they were contributors to the continuity of the mission and role of the Ancient Library.

One of the main sources of our information on the ancient texts was from Galen (2nd century CE), who wrote a commentary on the Hippocratic corpus. All traces of the Ancient Library had vanished by 465 CE, when Hypatia (mathematician and philosopher) was murdered, and Alexandria retreated into oblivion.



Hypatia



Cleopatra

Age cannot wither her, nor custom stale
Her infinite variety: other women cloy
The appetites they feed, but she makes
hungry Where most she satisfies: for
vilest things Become themselves in her.
Shakespeare, *Antony and Cleopatra*

The Emergence of the Revival Idea

The concept of the Revival of the Library of Alexandria actually emerged when Egypt decided to build the University of Alexandria. The University was initially named after the late King Farouk. In spite of the World War conditions; the building of the new University was a great achievement in Egypt's history. Dr. Taha Hussein, one of the most famous Egyptian literary figures was appointed President of the University of Alexandria. He reiterated in his inauguration speech that the new University was a rebirth of the ancient temple of the Muses and that the Library would be a forum for the pursuit of knowledge and research. This was the first inkling of strong support on Egypt's part to revive the Ancient Library, and to continue its great role, as a beacon of cultural knowledge.

The University of Alexandria continued to play an important role for the city and expanded to become the second largest in Egypt with 140,000 students, and 7,000 faculty staff members. It played a major part in the city's 2005 comprehensive urban development plan, backed up by a unique and progressive management which complemented the thrust to be the leading cosmopolitan cultural, urban and economic center in Egypt, as well as the region.



The University of Alexandria did not have a central library on campus to help students and faculty members do their studies and research work as all major universities in the USA and in Europe pride themselves for having, such as MIT, Princeton, Harvard, and Oxford, among others. I discussed this with Dr. Fouad Helmi, the Architecture Department Head, who supported the idea. Egypt had just suffered the 1967 defeat and was preparing to fight back, there was no chance of securing the financing of the Project. It was agreed that he would at least discuss our idea with the University President Dr. Mohamed Lotfi Dowidar, and at the same time conduct a research on the subject. A study on campus facilities planning was prepared in 1969, which was published by Beirut Arab University in 1972.



Coin: Inauguration of King Farouk I University

The President of the University of Alexandria, agreed with Dr. Helmi's proposal to add the Library to the University, and a committee was created to study the Library with Dr. El Sadr, University Vice-President, Dr. Helmi and Dr. Mostafa El-Abbadi (Faculty of Arts, Department of Greco-Roman Studies).

At the time, Dr. Helmi had good contacts in Cairo since his brother, Mustafa Kamal Helmi, was Under-Secretary of State to the Ministry of Education.

In parallel, while I was busy in the design and supervision of the construction of apartment buildings, the contractor placed window frames made of steel, wood and brass to test the endurance of materials

in the vacant site agreed upon (the actual site selected later for the Bibliotheca Alexandrina), which was the only remaining large tract owned by the University. This was at the Silsilah Peninsula, north of the Humanities campus. This site was available and due for construction before 1974. The whole tract was assigned by the Governorate of Alexandria to the University for academic use in 1954 with full ownership, and should be returned if not used before the lapse of twenty years. By the 1970s it was a matter of necessity that the University use the site. Since there was a threat of re-appropriation by the Governorate of Alexandria of the Chatby site, it was decided to build a complex of auditoriums at the vacant site that would also accommodate the increasing number of students, especially for the humanities faculties and educational facilities. The proposal was to build a main auditorium and three smaller auditoriums for lecture purposes by 1978.

As one of the few expert University scholars on Greco-Roman civilizations, Dr. Mostafa El-Abbadi wrote a book about the Ancient Library of Alexandria in Arabic. Dr. Dowidar and Dr. El-Abbadi discussed the idea of reviving the Ancient Library with the support of the University. Consequently, Dr. El-Abbadi gave a lecture to the Faculty Club in 1974 on the Ancient Library of Alexandria and alluded to the possibility of its revival and to the University Committee that was studying the proposal.

Over the next few years University Presidents changed frequently, but each one added his voice and effort to the ongoing work for the New Library. In 1976, a new President was appointed, Dr. Ali Reda El Henaidy. He was already involved in the Revival of the Alexandria Library, and established a new committee to study ways and means of its realization. Two committees were established, the first committee in 1977, consisting of nine members.

At the end of Dr. El Henaidy's tenure, Dr. Mahmoud El Hadary was appointed, as the new University President. A new committee was established, to study ways for the Library implementation, and new members were added, in addition to new ideas, such as:

1. Transforming the new auditorium into a conference center
2. Building a Library to fit the site of the conference center
3. Adding a five-star hotel to the complex, was suggested to serve all requirements, such as accommodations during international conferences that would take place there
4. Involving the Ministry of Tourism, to prepare feasibility studies to support the whole complex, since tourist activities would take place

5. Acquiring International involvement of UNESCO to support the new facility, since limited financial resources were available.

Studies by those committees were carried on during the late 1970s and early 1980s, however they did not yield concrete results.

After Dr. Farid Mostafa was appointed as University President in 1984, I was assigned the task of acquiring the British Consulate building located at Ramleh Station area for the University. It was finally handed over to the University in 1988. I was at the time also in charge of the Alexandria Comprehensive Plan for the 2005 Project, a joint effort between the University and the Governorate, 1981 - 1984. This is when I met with Dr. Mostafa again to renew the plan of progress and implementation according to the contact between the University and the Governorate.

I authored several publications and prepared a study on the Library's architectural program and functional components which were published by the University. I also initiated master plans, perspectives and programs, which were published in 1986.

Dr. Farid Mostafa reviewed the booklet and the design I had prepared on the New Bibliotheca Alexandrina and asked me to prepare the preliminary design for the Library as a consultant architect. I declined, telling him that any architect would be proud to do that, but I would deny myself the honor, preferring to have a UNESCO supported international architectural competition to attract the best design from international professionals thereby inviting international support, financing and contributions.

A new committee for the Project was established in March 1985 and Dr. Mostafa was appointed as the Honorary Chairman to review the Project development on 27 March 1985. The President of this Committee was Dr. Dowidar, with Dr. El-Abbadi, Dr. El-Sadr (University Vice-President) and myself, as rapporteur of this committee. It was decided to broaden and strengthen the original Preparatory Committee, to enlist national support and involvement, by including national intellectuals, writers and academics.

Dr. Farid Mostafa asked H.E. Fathallah El-Khatib, Egyptian Ambassador to the Permanent Delegation to UNESCO to look into the possibility of UNESCO's support for the Project.



Old British Consulate

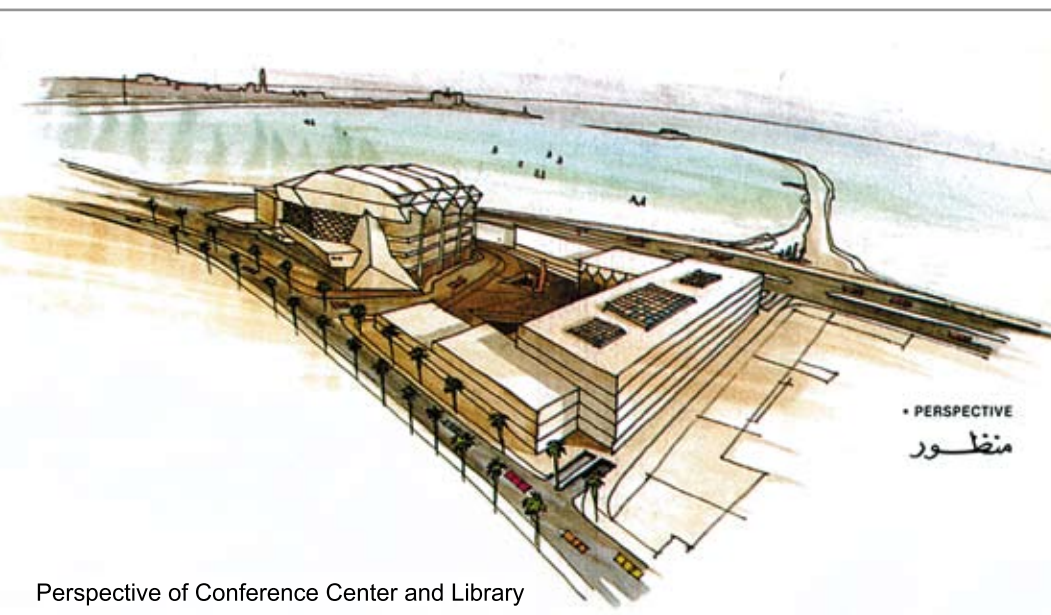

Perspective of Conference Center and Library

Dr. El-Hadary wrote to the Minister of Higher Education, Dr. Fathy Mohamed Ali, in 1982 asking to enlist UNESCO'S support. Later on, Dr. Mostafa invited Amadou-Mahtar M'Bow, UNESCO Director-General, to visit the University during the tenure of Dr. Fathi Mohamed Ali, the newly appointed Minister of Education. They met with the Preparatory Committee and visited the site agreed upon for the New Library in Chatby/Silsilah where the Conference Center was still undergoing construction in 1986/1987 due to lack of proper funding. Mr. M'Bow informed us that UNESCO did not support provincial Projects, but did sponsor national Projects approved by the central government. He suggested that the proposed library be renamed the "Revival of the Ancient Library of Alexandria", rather than "the University of Alexandria Library", to enlist the support of the international community and various countries.

The following University President, Dr. Abdel Aziz Abou Khadr, was appointed in 1987. He appointed me as principal consultant in charge of the Library and all contacts. He added new members to the committee, as had been previously recommended, by issuing a new decree to include prominent intellectuals such as Dr. Zaki Naguib Mahmoud, a famous professor and highly regarded thinker in Cairo, and Ahmed Bahaa Eldin, a prominent writer and columnist at Al Ahram Publishers in Cairo and Father George Kanawaty, the famous Christian theological intellectual, who also appointed me as his advisor on the Project.

In the same year, the Committee requested through the Minister of Higher Education, that President Mohamed Hosni Mubarak would honor the Project and would place it under his auspices. President Mubarak declared his acceptance of this arrangement in 1987.

Accordingly, in response to UNESCO'S procedures and to further the national role, it was important to enlarge the committee to include cabinet members, representing other ministries. A decree by the Prime Minister in 1988 was enacted, to include various concerned ministries to the National Preparatory Committee under the chairmanship of the Minister of Higher Education, Dr. Ahmed Fathi Sorour, who had already given his full support from the beginning of this Project. This fact should be duly recognized, acknowledged and appreciated. Dr. Sorour was elected President of the Egyptian Parliament and ceased his direct contact with the Project in December 1990. Dr. Adel Ezz succeeded him to oversee the Project development for a few months until Dr. Hussein Kamel Bahaa Eldin, new Minister of Education, was appointed in May 1991.



President Hosni Mubarak and Mohsen Zahran



Mrs. Mubarak and Mohsen Zahran



UNESCO Expert Group Meeting

Meanwhile, a UNESCO sponsored *Ad Hoc* expert group meeting which I chaired held in March 1988, in Alexandria. It was agreed to hold the International Architectural Competition with the support of the International Union of Architects (IUA). A professional committee was created of international experts, including myself, to prepare the architectural brief based on my earlier proposal.. It met in Alexandria and in Paris with Françoise Lombard representing the IUA. Dr. Esmat Abdel Maguid, a devoted Alexandrian and Egyptian Minister of Foreign Affairs, whom I knew back in Paris in 1965, was contacted to enlist UNDP support to finance the competition and start the fund-raising tasks. He succeeded in getting the UNDP Director-General to allocate US\$ 600,000, which was later raised to US\$ 1,200,000 in January 1988.

Following that generous support, President Mubarak, in the presence of Mrs. Mubarak, Federico Mayor (Director-General of UNESCO), the representative of UNDP in Cairo, the Prime Minister and Minister of Education, laid the cornerstone of the New Library on 26 June 1988. I was delighted to show the President, Mrs. Mubarak and the VIPs the site plans and program of the Library that I had prepared earlier and printed in the 1986 booklet, published by the University of Alexandria.

It was during this visit that I met Mrs. Suzanne Mubarak for the second time. I had the honor of meeting with her one year earlier during the opening of the Alexandria International Gardens, which I had planned and implemented. She became deeply interested in the Library Project from this occasion onwards and this presented many possibilities for her future involvement, especially since she also became Chair of the International Executive Committee. The Library has continued to arouse the Government and the public towards greater commitment to eradicate illiteracy, promote greater education and comprehensive human development.

First Publication on the BA by the University of Alexandria

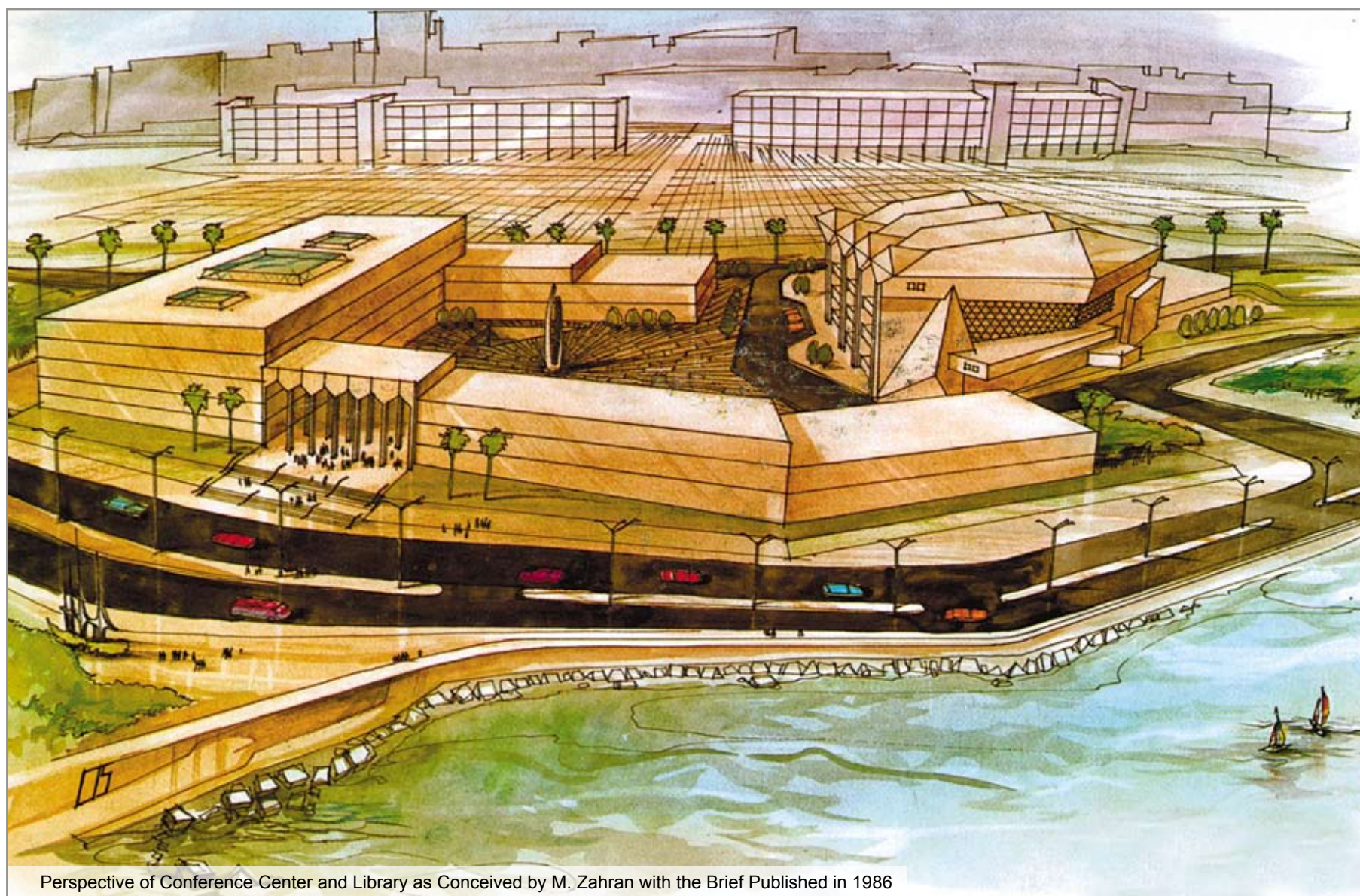

Perspective of Conference Center and Library as Conceived by M. Zahran with the Brief Published in 1986

300 BCE					The Bibliotheca Alexandrina Time Progression				
Ptolemy II Philadelphus (308-246) and Arsinoe I / Arsinoe II		Eratosthenes of Cyrene Librarian 245-204/1		Ptolemy III Euergetes (299-221) and Berenice II		Ptolemy IV Philopater(244-205) and Arsinoe III		Septuagint	
200 BCE									
Ptolemy II completes construction of Pharos, Mouseion, Serapium, Library		Ptolemy V Epiphaes (210-180) and Cleopatra I		Apollonius Edograph Librarian 189/6-175		Ptolemy VI Philometor (186-145) and Cleopatra II			
200 BCE									
Aristophanes Librarian 204/1-189/6		Aristarchus Librarian 175-145		Ptolemy VII Neos Philopator (162-144)		Ptolemy VIII Euergetes II (182-166) and Cleopatra II/ Cleopatra III		Kydas (one of the Spearman) Librarian 145-116	
200 BCE									
Ptolemy IX Soter II (Lathyrus) (141-81) and Cleopatra IV/ Cleopatra Selene		Ptolemy IX Soter II (Lathyrus) (141-81) and Cleopatra IV/ Cleopatra Selene		Ptolemy X Alexander I (140-88) and Cleopatra Berenice					

100 BCE

Ptolemy XI Alexander II (100-80) and Cleopatra Berenice

Ptolemy XII Theos Philopator Neos Dionysus (Auletes) (116-51) and Cleopatra V

100 BCE

Ptolemy XIII (63-47) and Cleopatra VII

Ptolemy XIV (59-44) and Cleopatra VII

Cleopatra VII (69-30)

48 BCE

Ceasar's Fire
Major Fire in the Library

200 CE

Claudius Ptolemy (127-48 CE) – Geographer

Strabo (64 BCE-21 CE)
Plutarch (100 CE)

Destructive events in Alexandria continue

215 CE, Emperor Carcalla
272 CE, Queen Zenobia of Palmyra
273 CE, Emperor Aurelian

297 CE, Rebellion Galen

400 CE		400 CE	
391CE, Theodonus I	Theodonus II (408-450 CE)	St. Jerome 400 CE, writes of empty Royal Quarter	415 CE, Hypatia murdered

500 CE		600 CE		1940	
John Tzetzes writes in 12 th Century		642 CE, Arab Conquest			

1942	1968	1974	1985		
Farouk I University (University of Alexandria) Inaugurated	Proposal for University of Alexandria Library	Alexandria University initiates Revival Project	University donates Chatby site to the Revival project	National Preparatory Committee appointed	

1986	1987	1988		1989
UNESCO DG visits University of Alexandria	UNESCO Appeal	1988 International Architectural Competition	President Mubarak lays Foundation Stone with Federico Mayor (UNESCO) 26 June 1988	GOAL established by Presidential Decree No. 523/88

1989		1990			
1989 Competition Award to Snohetta a.s.	Executive Director of GOAL appointed	Preliminary Design Review	GOAL begins staff recruitment	First IC Meeting in Aswan 12 February 1990	Aswan Declaration signed

1990	1991	1992	1993		
Project Agreement signed	GOAL begins book acquisitions	PM and DPM appointed, Staff recruited	Executive Secretariat Headquarters established	April, First IEC Meeting in Alexandria	Design and Supervision Contract signed

1993			1994		
Design work begins	Seat Agreement Endorsed by the Egyptian Parliament	December, Second IEC Meeting	Prequalification and Tender Action for Phase 1	Phase 1 Contract to Rodio-Trevi-Arab Contractors Joint-venture	BIBAl bibliographic format for the Information System developed by ES staff

1994		1995			
November, 1994 – First International Symposium on the Library's Intellectual Contents	Cataloguing of Municipal Library's manuscripts begins	Norwegian contribution for the Front House Furniture	May, Third IEC meeting	Phase 1, foundations contract award to RTA May, Construction works of Phase 1 begin	

1995				1996
Prequalification and Tender Action for Phase 2	Second International Symposium on the Library's Intellectual Content	Conservation and Restoration Laboratory through Italian contribution, established at executive Secretariat	University of Colima (Mexico) contributes 53 CD-ROMs	ES publishes Collection Development Policy

1996				1997
April, BA goes on the Internet	May, First International Meeting for the Friends in Athens	7 December 1996 Phase 2 Contract signed with Balfour Beatty/Arab Contractors Joint-venture and work commences	December, Phase 1 construction completed	February, A/V Roundtable

1997					
Spanish gift of the Arabic Escorial manuscripts 19 June 1997	BNF books donated 15 November 1997	Cap Gemini begins study for the Information System	September, Second International Meeting of the Friends in London	Microfilm Lab. Established at ES	Digital Lab. established at the ES

1997			1998	
2 nd Meeting of the International Friends in London	November, Forum for European Cooperation with the BA	Saur Verlag gift of books 4 November 1997	June 1998, Greek contribution of US\$ 200,000 and copies of antiquities	October, First International BA Symposium: the BA Continuum

1998					1999	
March, Cap Gemini delivery of Prototype of new Information System	Symposium by GOAL/BPI 17-19 May 1998	September, Third International Meeting of the Friends	Protocol with Limoge Library 11 September 1998	Protocol with National Library of Quebec 7 March 1999		
1999						
November, Second International BA Symposium: the BA Continuum in Alexandria	April, Installation of Book Transportation System (gift from Germany)	H.E. Turkish President Demirell visits Library and donates books	Copy of Rosetta Stone donation by the British Museum	CNED Protocol 8 April 1999		
1999						
Spanish gift of the Cordoba manuscripts	Czech Republic Book donation 15 September 1999	Protocol with IAW 18 March 1999	Donation of Russian miniature books 17 April 1999	Japanese Cultural Grant for A/V equipment 7 January 1999	May, BA Symposium in Paris	
1999		2000				
Norwegian furniture installed in library reading halls in August	AGFUND UNESCO/ ISESCO contribute to Library for the Blind	UNESCO financial donation for expertise, training and equipment	Ferdinand de Lesseps Association and Suez Canal Authority (Ismailia) contribution of Suez Canal documents 18 April 2000			

2000					
German "Travel-Ahead" exhibit at the CCA February 2000	Egyptian Government approves IS through French Agreement 27 March 2000	VTLS donation	Shanghai protocol and book donation 9 April 2000	Library areas furniture installed	

2000					
History of Science Museum installed	Protocol with Center d'Etudes Alexandrines 6 June 2000	Protocol with French Center-Alexandria 6 June 2000	Protocol with ENSSIB December 2000	Protocol of International Cooperation with Spain	

2001					
Equipment for Library for the Visually-impaired installed at ES	German Friends donate financial support, equipment and books	Italian FIT 2 approved by Italy and UNESCO 2 February 2001	Greek donation of Antiquities Museum showcases April 2001	Roundtable for Suez Canal archives 2 April 2001	Protocol of Cooperation with Russian Academy of Sciences

2001					
New Law 1/2001 for BA	Phase 2 Construction completed (28 March-7 July 2001)	Mrs. Mubarak announces completion on 3 May 2001	Soft opening (1 October)	1 st meeting of the Board of Trustees	

2002				
4 th and 5 th meetings of the International Friends	INAUGURATION 16 October 2002	1 st Council of Patrons Meeting	Opening of BA to the Public	



“ The future is our most precious common good, and it is intact.
We can share it, all our hands can help to write it.
The past? All we can do is underwrite it.”

Federico Mayor
UNESCO Director-General

CHAPTER 3

CHAPTER 3

INTERNATIONAL COMMUNITY
INVOLVEMENT AND NATIONAL
COMMITMENT

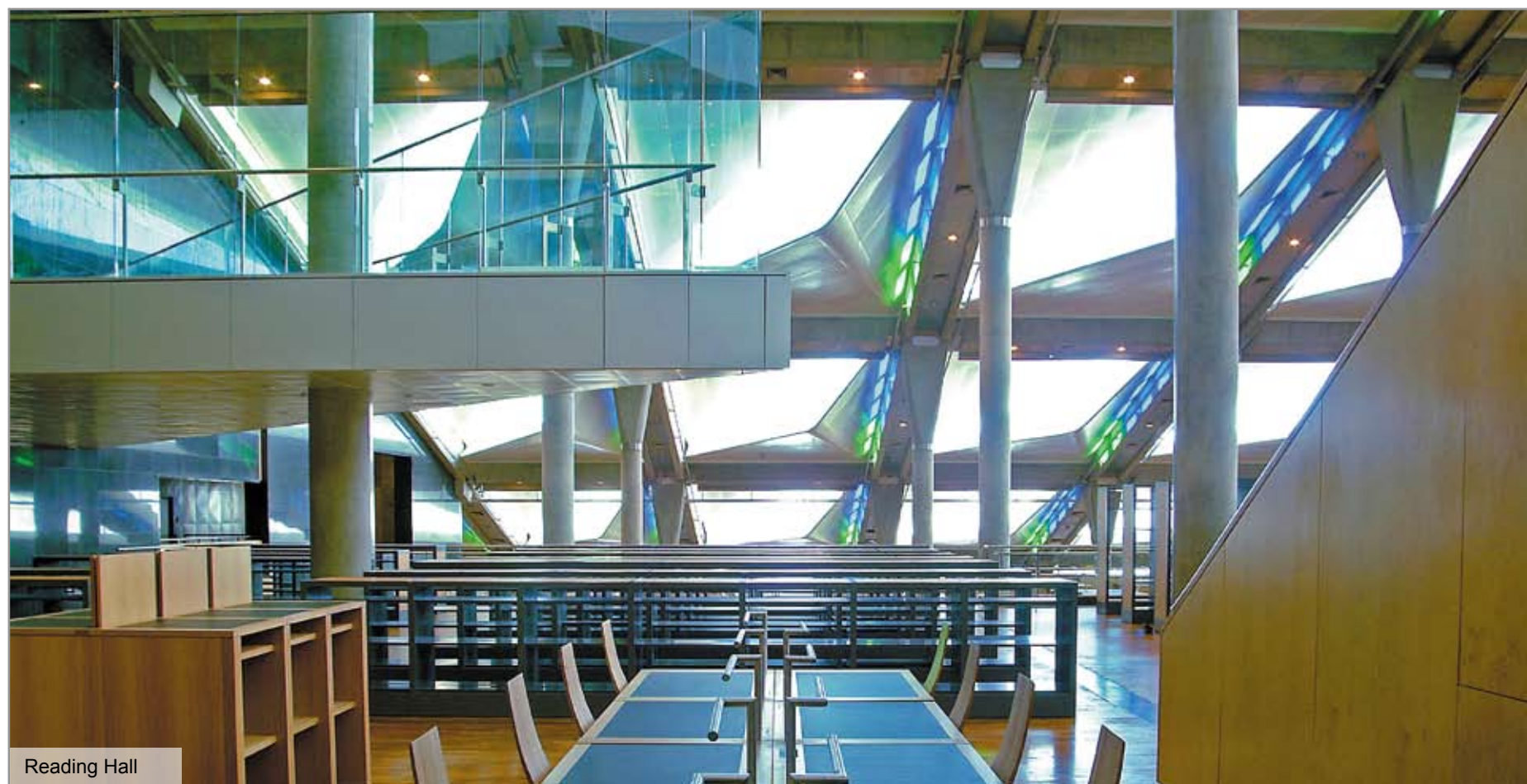

Reading Hall

UNESCO Support

The Project of the Revival of the Ancient Library went to the very heart of UNESCO, as the Director-General of UNESCO once declared during the Inaugural Aswan Meeting of the International Honorary Commission, in 1990. UNESCO's main mission was to transmit the cultural dimension into national development, through human knowledge. UNESCO's support had been crucial to the realization of the Project, whether in its first steps of feasibility studies or during the "Appeal" for the support of the International Community, during the Campaign fundraising, for the construction of the building, and the purchase of equipment, training of staff, and in supporting the idea to pave the way for the constitution of a global system of information and informatics networking level.

After the participation in laying the cornerstone at the allocated site for the new building on 26 June 1988, UNESCO began its serious work towards the implementation of the Project. The agreement between

Egypt and UNESCO covered the understanding of the tasks and responsibilities of each partner, and also the principle formation of three bodies which would be responsible for managing the Project over time. These bodies, the International Commission (IC) for moral and financial support of the Project; the International Executive Committee (IEC) to oversee the general management of the Project; and the Executive Secretariat (ES) to take care of the day-to-day running of the Project and oversee the staff in cooperation with the General Organization of the Alexandria Library “GOAL”, established in 1988.

Following the Egyptian Government’s formal request of UNESCO’s support, the Executive Board and General Conference of UNESCO adopted on 22 October 1987 during its 124th session decisive resolutions in favor of the support of the new Bibliotheca Alexandrina. Fathallah El Khatib, Egyptian Ambassador to UNESCO, played a vital role in mustering support and in the adoption of these resolutions. Subsequently, UNESCO sent a delegation of its experts to Alexandria to collect information concerning the various ways and means of support.

Amadou-Mahtar M’Bow, the UNESCO Director-General, issued the first universal “Appeal” on 26 October 1987, urging all Member States, whether governments, institutions, organizations, individuals to contribute to the Project, either financially or in kind. The appeal explicitly declares:

I therefore call on the Governments of all states, international governmental and non-governmental organizations, public and private and last but not least, the people of all countries to participate, by means of voluntary contribution in cash, equipment, or services, in the immense efforts undertaken by the Egyptian Government to reconstruct and equip the Library of Alexandria, constitute and preserve its collections and train the requested personnel.

Upon the request of the Government of Egypt, UNESCO launched an international appeal for this unique and exceptional Project, to meet the cost of both the building and book collections. The Egyptian Government believed that such a valuable Project must be supported by the world, which could help translate the dream into reality. Consequently, UNESCO and Egypt cooperated to prepare the first donor conference in Aswan on 12 February 1990. The support of UNDP and UNESCO to promote the cultural, intellectual dimensions of this unique Project triggered international cultural cooperation.





Palestine Hotel Meeting

UNESCO consultants and experts were recruited from Germany, USA, UK, France and Japan, to carry out feasibility studies in four major areas:

- The architectural aspect included the components, functions, uses and activities of the new building based on field studies surveyed on available libraries of Alexandria in cooperation with a special report on existing shortages and problems.
- The second aspect concentrated on the intellectual content and the collection development acquisition policy of both traditional and electronic books within a well-planned time scale. The target was that the Library should have an optimum capacity of 4,000,00 volumes reaching 8,000,000 ultimately with compact storage. It was decided that the Library should have on the shelves, a minimum of 2,000,000 volumes at the Opening, covering the specific fields and disciplines that have been well defined.
- The third aspect dealt with automation. Our new electronic age has made available unprecedented development information, technology and communications revolution. The New Library of Alexandria should be a state-of-the-art, public research center, that would carry the mission of the research excellence and intellectual dialogue continuing the famed reputation of the Ancient Library of Alexandria, as a unique lighthouse of knowledge, to best serve Egypt, the region and the world beyond, through cyberspace networking with the world's major modes of knowledge.
- The fourth aspect concentrated on the International School for Information Science (ISIS), which was an important key component of the New Library of Alexandria. ISIS was planned originally to be an important educational and intellectual Library facility, which would graduate students in library and information sciences, to become capable professionals in this field of expertise, which is needed in Egypt and the Arab world. Besides, it would provide visitships for scholars in residence to conduct leading research work to be published and disseminated worldwide.

After his election as the new Director-General of UNESCO in 1987, Federico Mayor, reissued the same appeal in 1988. He also declared the Project to be an integral part of its “Cultural Decade” program (1988-1998). As the Project progressed, UNESCO also took responsibility to prepare a focal point on its website for the Bibliotheca Alexandrina Project. This provided greater credibility to the Project and made the international community more aware of what was going on, and kept them updated on the milestones in the execution work.

UNESCO sponsored a visit in March and April 1987 by the two members of the University of Alexandria Preparatory Committee (Loutfy Dowidar and myself) to acquire meaningful knowledge and experience from fifteen libraries in Europe, including those in England, Scotland, Germany, Switzerland and France. The visit was followed by a strategy meeting at UNESCO Headquarters in Paris in April 1987, to prepare and coordinate steps to be undertaken for an action plan to muster resources. This included an important agreement to convene an *Ad Hoc* International Expert Group Meeting in Alexandria, to be sponsored by UNESCO, in March 1988.

The International *Ad Hoc* Expert Group Meeting was held in Alexandria, 21-24 March 1988. UNDP approved to provide a grant that was later raised to US\$ 1.2 million (UNESCO Project EGY/88/003) to support the competition expenses, publications, equipment, consultancies and fundraising efforts, with UNESCO as the executive agency. The Project was officially launched when President Hosni Mubarak laid the cornerstone for the Library on 26 June 1988 in the presence of Mrs. Mubarak, Dr. Mayor, UNESCO Director-General, UNDP representatives, the Prime Minister, and other high government officials and international personalities. UNESCO was fully involved in the preparation of the documents; issuing announcements and carrying out all of the International Architectural Competition in Paris and receiving all the competition presentations.

The Egyptian Government and UNESCO did not waste time, and resolved the future of the Project together by signing a joint agreement on 26 October 1990 to achieve this objective. The Project Agreement was ratified by the Egyptian Parliament and was enacted by the Presidential Decree creating three bodies for the Project implementation.

- The International Commission (IC) which held its first meeting in Aswan.
- The International Executive Committee (IEC), which includes representatives of the major countries, Egypt and UNESCO, to be chaired by Egypt's Minister of Higher Education and the Chairman of GOAL. The IEC was responsible for approving the Project work plan and budget. It was originally planned to meet annually, but actually the IEC could only meet three times during the lifespan of the Project.
- The Executive Secretariat (ES) to be headed by a UNESCO senior staff member as the Project Manager, and entrusted with the execution of all decisions and Project management and operations. The Project Agreement, signed on 26 October 1990, was followed by a second, and



UNESCO Silk Road Tour at Alex Port



Ad Hoc Expert Group Meeting



BNF Officials Visit to the Site



Finnish Experts

equally important, agreement for the functions, duties and operations and juridical standing of the Executive Secretariat, named the “Seat Agreement”. This agreement was signed on 1 November 1993, and was also approved by the Egyptian Parliament and enacted by Presidential Decree

UNESCO collaborated in the creation of the International Honorary Commission (IC), chaired by Mrs. Suzanne Mubarak, which was held in Aswan on 12 February 1990, in agreement and cooperation with the Egyptian Government. Presidents, Royalties, High dignitaries, President Hosni Mubarak addressed the meetings as well as Mrs. Mubarak, President Mitterrand, Queen Sophia, Queen Noor El Hussein and Federico Mayor UNESCO Director-General. At the end of the Historical Meeting, the IC members signed the Aswan Declaration that supported the Project implementation. It was published by UNESCO and circulated to all Member States. The Aswan Meeting resulted in an overwhelming financial support by Arab countries, through personal contacts, and President Mubarak’s friendship with the Arab Heads of State, who pledged and paid US\$ 65 million to Egypt for the Project execution. This substantial financial contribution raised during the Aswan Meeting in February 1990 catapulted the Project realization into a new phase of implementation.

UNESCO gave the Project credibility to the outside world and provided strong moral support to Egypt and the other Project supporters. UNESCO’s handling of contracts and actions with the Project were always transparent.



Hosni Mubarak with Jacques Tocatlian, UNESCO

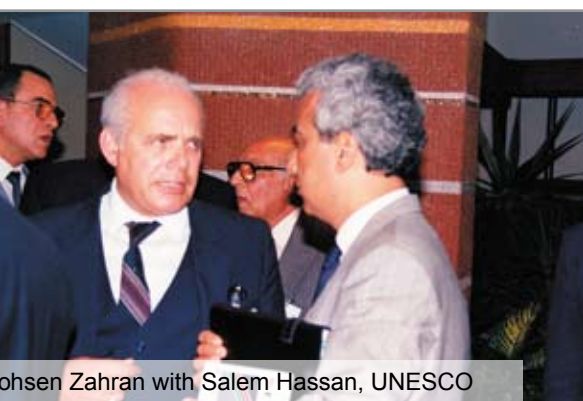

Hosni Mubarak with Salem Hassan, UNESCO

- UNESCO sent out a team of professional fund-raisers to muster further support from the Arab region after the success of the Aswan meeting. Regretfully, these efforts were met with poor success. Thereafter, the fund-raising was carried out through bilateral and multilateral contracts, grant requests, issued through existing accounts at UNESCO, or directly to the Egyptian Government.
- UNESCO was also responsible for the management of the implementation of a number of important financial grants for the Library from Italy, the Arab Gulf Fund, and the British Council.
- It was agreed with UNESCO to allocate nearly US\$ 50,000 for staff training in major libraries in Canada, France, Germany, Spain, the UK and the USA with UNESCO’s direct involvement.
- A UNESCO liaison officer was assigned to the Project to follow up its progress and help coordinate the establishment and continued involvement of the International Friends Associations in about eighteen countries worldwide.

- An allocation of US\$25,000 was made available by UNESCO for establishing the Library website, the production of an electronic database and a DVD on the Ancient and the New Bibliotheca Alexandrina.
- UNESCO's regular budget for the support of the staff training, equipment procurement and consultancies made appropriations available. The Ministry of Culture, High Council Antiquities, in cooperation with UNESCO, the French Ministry of Culture, the Hilti Foundation held a conference on "The Sunken Monuments in Alexandria's Eastern Harbor", in the Alexandria Conference Center on 3 November 1996. The new discoveries of the sunken monuments under the water in the harbor across the Corniche Avenue from the construction site gave factual evidence that the New Library site is located in the Ancient Royal Quarter. The Royal Harbor and thousands of archeological items were found.
- The UNESCO Executive Board and General Conference agreed in November 2000 to continue to support the operations and activities of the New Library of Alexandria after its International Inauguration in 2002 and remains to perform this role at present.

International Meetings

Many international meetings, seminars and conferences were held to acquire the support of the international community. They had the twofold purpose of informing people about the New Bibliotheca Alexandrina, and also providing support, commitment, and new research and scholarship on the aspects of the Ancient Library. The Preparatory Committee organized these seminars which shed light on the heritage of the Ancient Library. These were further expanded upon in symposia held in Alexandria and in Paris, London, Athens, Naples, Rome, Ankara, Seville, Madrid and elsewhere. It is noteworthy to refer to the following vital meetings:

1. An international seminar on the "Intellectual Heritage of the Ancient Alexandria Library" was held at the University of Alexandria in March, 1986 with participation and research papers submitted by 34 scholars from Egypt, Greece, Italy, France, the UK and Germany.
2. An international seminar on the influence of the "Ancient Alexandria Library Scholarship on the Advancement of Human Knowledge in Today's World" was held at the University of Alexandria, in April 1987, with the participation of 22 scholars from Egypt and Europe.

3. The International *Ad Hoc* Expert Group Meeting was held at the University of Alexandria, 21-24 March 1988.
4. The international meeting for the announcement of the results of the International Architectural Competition, was held on 25 September 1989 at the Alexandria Conference Center under the auspices of Mrs. Suzanne Mubarak.
5. The Inaugural Meeting of the Honorary International Commission was chaired by Mrs. Suzanne Mubarak and held in Aswan on 12 February 1990.

National Commitment

The intensive and determined support of Egypt was unparalleled. The Ministry of Education became the responsible Ministry for the Project at the national level. The Project supporters had early on decided that the New Library would be much greater than a repository for books, and should take up a leadership role in the dissemination of knowledge. Fathy Surour was the first Minister (1987/1990) to be directly involved. Adel Ezz (1990/1991) succeeded him for a few months time until Hussein Kamel Bahaa Eldin was appointed Minister of Education. He should be credited for his support and follow-up of the Project from 1991 to 1997 and the signature of the Design contract as well as the Phase I and Phase II construction contracts. Moufid Shehab was then appointed Minister of Higher Education and State for Scientific Affairs and continued the same role from 1997 to 2001. Dr. Shehab was formerly President of Cairo University, a legal consultant of GOAL, and an eminent international lawyer.

The General Organization of the Alexandria Library (GOAL) was created by Presidential Decree 523/1988 issued on 14 December 1988. I was accordingly appointed as Executive Director on 8 February 1989. GOAL established its first offices in the Scientific Library building belonging to the University of Alexandria. It immediately began receiving donations for the Library collections from institutions, governments and even individuals around the world who had learned of the UNESCO “Appeal”.



President Mubarak, Cairo Bookfair



PM Al-Ganzoury at site



IEC Second Meeting

Support from the Alexandria Governorate

It is important to highlight the great support that the Alexandria Governorate marshaled for the implementation of the Bibliotheca Alexandrina Project. The former Governor, El-Sayed Ismail El-Gawsaky, manifested this support in many ways and means, as has the former Governor of Alexandria, General Mohamed Abdel Salam El-Mahgoub. Both Governors gave unlimited local, regional and national support to the Project from the very beginning. In fact, the site that was allocated for the Project was originally owned by the Governorate and offered to the University of Alexandria to use for educational purposes within 20 years after which, if it had not been used for those objectives, the appropriation would have been revoked.

Another vital contribution to the Library collections was the donation of more than 5000 rare books and manuscripts of the Municipality Library that became the seed collection of the new Rare Books Department.

Support also came through the following administrative and municipal actions:

1. Facilitation of the speedy issuance of the Library building permits.
2. Approval of the issuance of a building permit to build the extension of the Conference Center to the west.
3. Recommendations to the utility authorities and companies in Alexandria to respond quickly and cooperate actively with the Library management to provide all the connections needed for water supply, sewerage, and electricity and telephone networks, at discounted installation charges.
4. Issuance of permits to add one lane of the Corniche avenue on the north side of the site for the sole use of the Contractors during the construction, and a lane from Port Said street on the south side.
5. Most of the beautification and urban upgrading Projects in the city of Alexandria during the last five years were to prepare the city for the Inauguration of the New Library of Alexandria.
6. Needless to say, the widening of the Corniche to the north embellished the Library with the scenic view of the waterfront.





“ As the pyramids have become the symbol of ancient Egypt, this new form, in its relation to the harbor, will become a symbol of the revival of the old Library of Alexandria.”

John Carl Warnecke,
Chairman of the Jury, Competition 1989

CHAPTER 4

INTERNATIONAL
ARCHITECTURAL COMPETITION



Reading Hall Cascading Levels

Preliminary discussions with the representatives of the Egyptian Government and UNESCO proposed an international competition as a strategy to attract the best and brightest architects, and more importantly to capture the hearts of people everywhere. UNESCO immediately recruited its experts to complete the initial technical reports and a feasibility study for the Library in March 1988. An International Architectural Competition for the design of the New Library was recommended, and the Egyptian Government endorsed this recommendation. Planning began immediately thereafter.

It was believed that the need to organize and carry out the Competition precipitated the following important results:

- Substantial support by UNDP in the amount of US\$ 1.2 million to support the cost of the Competition plus other aspects of the Project;

- A greater involvement by UNESCO as the executing agency of the UNDP grant;
- The engagement of the International Union of Architects (IUA), to provide international credibility and the standards for the Project execution;
- The conviction of professionals worldwide to participate actively in the Competition, as evidenced by the registration of nearly 1400 firms from 77 nations and the final submission of nearly 540 competing Projects from 44 nations;
- A wide international media coverage on the Competition, the Project's goals and objectives, which gathered the world's attention, interest and support.

The effective media coverage of the Competition intensified world interest, and resulted in the international community's support, including governmental and non-governmental institutions, associations, and individuals. Without the Competition, the Project would not have received such support and international contributions and probably would not have accomplished such a professional excellence and execution worthy of its renowned name and universal goals. Consequently, it is essential to underscore the following aspects of the Competition:

Arrangements

According to the UNDP grant, the International Architectural Competition was designed to award US\$ 200,000 in prizes for the following:

- First Prize US\$ 60,000
- Second Prize US\$ 35,000
- Third Prize US\$ 25,000
- The remaining US\$ 80,000 was divided among the entrants awarded a special mention by the Competition Jury.

Organization

UNESCO experts prepared the feasibility studies before launching the Competition to indicate the important aspects of the design that they would have to incorporate into their conception. The feasibility studies determined

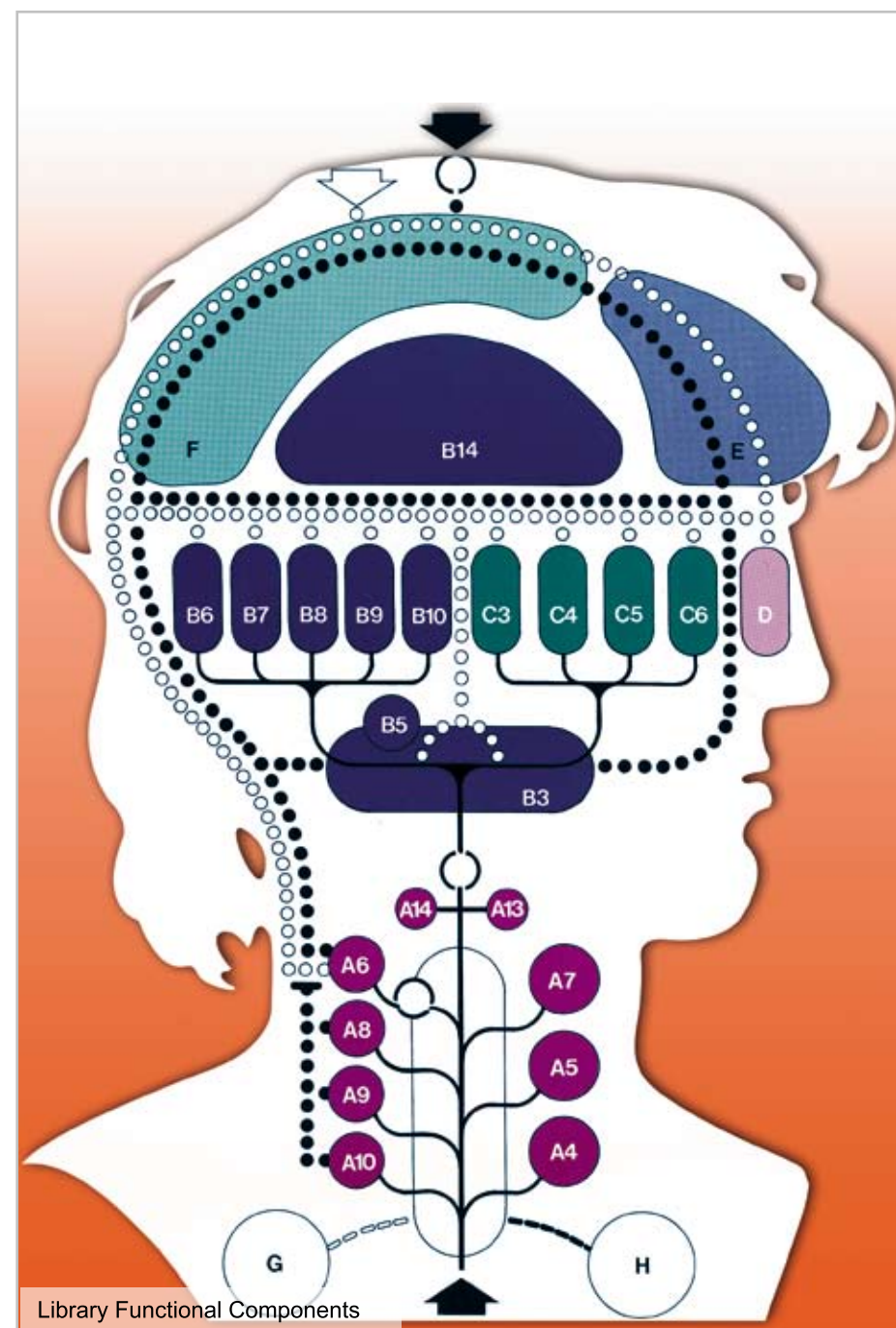

the architectural functional and planning requirements for the New Library, multiple facilities, functions and services, the future of the collective development of the Library, the human resource development including expectations for staffing, and the automation and information technology needed for a new state-of-the-art Library. The International Union of Architects (IUA) was enlisted to organize the Competition because of its prestige, experience, the knowledge of its members, and its accessibility to architects throughout the world.

Jean Pierre Clavel, a highly regarded university librarian from Switzerland and Jan Meissner; a Polish architect, were UNESCO experts. Francois Lombard; a French architect represented the IUA. I had already prepared the updated Architectural Brief for the Preparatory Committee in 1986. This was reviewed, augmented and subsequently published by Jean-Pierre Clavel and Jan Meissner with the assistance of François Lombard, as the Architectural Brief and Competition Rules by UNESCO–Paris in 1988, with due reference to my input and Harry Faulkner Brown, a British architect, acting also as a UNESCO expert.

The Architectural Brief outlined the organization of the Library, including its administration, departments, and activities. It was to have a “Public Services Division” that included a cultural activities department, a books and periodicals collections department, a special collections department; an “Internal Services Division” for administrative services, technical services, operational support services; the International School of Information Studies (ISIS), the Conference Center and Ancillary Services.

It stipulated requirements for accessibility, comfort, flexibility, compactness (to optimize movement of staff and books), expansion, extendibility, safety and security, and special technical requirements for various types of rooms. It also mentioned the types and need for the centralized technical systems that would be required, and the economics of the Project. Specific floor areas required for the Library sections were suggested as well as furniture and equipment required for all spatial accommodations.

The Competition was announced in the IUA journal. The notice immediately drew the attention of architects, young and old, from around the world. The Competition was launched in September 1988 and by November (the same year) more than 1400 applications from 77 countries were registered, and bought the Architectural Brief and Competition Rules through UNESCO (for US\$ 150 each) in October 1988.

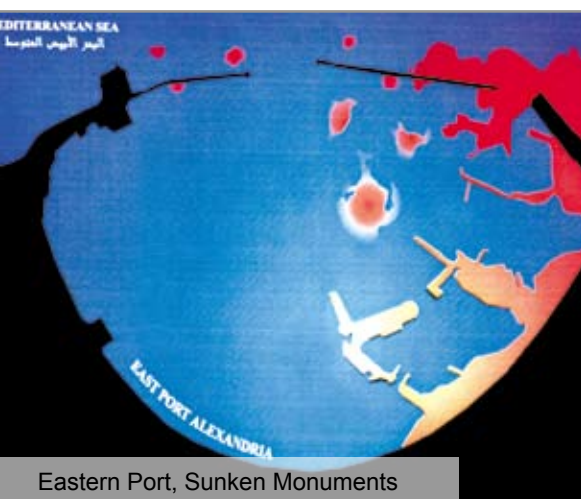

Eastern Port, Sunken Monuments



Library Urban Context

Implementation

In accordance with Competition rules, the final date for mailing Project submissions to UNESCO was 9 June 1989. The Permanent Delegation of the Arab Republic of Egypt at UNESCO was charged with receiving those submissions. Only thirty-seven Projects were delivered after the deadline. Candidates had to submit two sets of drawings and two copies of a written report on their Project. Through UNESCO facilities and personnel in the Paris headquarters, the submissions were received and registered methodically from 23 to 29 June, just as a tender submission for a contract would be carried out, with similar procedures and protocols followed. This included opening the Project rolls, checking the postage date, reviewing and recording the contents of each roll, and attaching a serial number to each submission (replacing the code number) to preserve anonymity. After registration, they were placed in four containers and shipped to Alexandria in July 1989.

A total compilation of 524 completed Projects, from the original 1400 registrants, was sent to the General Organization of Alexandria Library (GOAL) in Alexandria, at the Conference Center where the judging procedures were to take place. In the meantime an international jury was recruited in 1989 which included seven professional architects, a member of the IUA, and two librarians:

Charles Correa, Architect, India

François Lombard, Architect, France

Fumihiko Maki, Architect, Japan

Franco Zagari, Architect, Italy

Jean-Pierre Clavel, Librarian, Switzerland

John Carl Warnecke, Chairman, Architect, USA

Mohammed Aman, Librarian, USA

Mohsen Zahran, Architect, Egypt,

Pedro Ramirez Vasquez, Architect, Mexico

In addition, three Professional Advisors-Deputy members of the Jury were engaged:

Ahmed Helal, Librarian, Germany

Harry Faulkner-Brown, Architect (specialized in library facilities planning), UK

Jan Meissner, Architect, Poland

A Technical Committee was appointed to check, analyze and study all Projects in accordance with the Competition brief and regulations, and to report their findings to the International Jury. Therefore, two one-week Technical Committee meetings were organized from July to September 1989 for this purpose. This Technical Committee included:

- Ahmed Helal, Librarian, Germany
- Harry Faulkner -Brown, architect, UK
- Jan Meissner, architect, Poland
- A team of about twenty young Egyptian architects including junior faculty members and young graduates from the Department of Architecture, Faculty of Engineering, Alexandria University was selected to assist the Committee.

All the Projects were displayed on 500 wood panels at the Conference Center. The submissions (four sheets/100x70 cm per Project) were examined by the Technical Committee to ensure they adhered to the Competition rules, and whether the local regulations and main functional requirements of the Project were met. The Committee determined that 212 Projects did not comply with the regulations in respect to one or more aspects of the competition rules, and 145 were judged as insufficient to be judged. This meant that 167 Projects complied with the competition criteria.

The selection of the prize winners was not easy, since many creative and thoughtful Projects were presented. However, as we walked through the three floors of the exhibition spaces we found that we kept returning to certain designs over and over again. Finally, at the end, I was walking back to Cecil Hotel on the Corniche with Dr. Warneke. The sun was setting, large and beautiful, and I remarked to him that the Project no. 90, was like this sun, and he emphatically agreed.

On 22 September 1989 the final decision was reached. After voting and final selection, the jury opened the sealed envelopes to identify the prize winners. Snøhetta a.s., a young Norwegian-led team, won the first prize and I called them in Oslo. I spoke to Mr. Kjetil Thorsen and invited them, along with the other award winners, to fly to Alexandria to attend the official announcement. On 25 September 1989, a ceremony was held at the Conference Center to announce the Competition results. The ministers, government officials, UNESCO and the media were invited along with the three prize winners.



Jury Deliberations

Judging Procedures

The International Jury met in the Alexandria Conference Center on 17 September 1989. Mr. John Warneke was elected chairman, and I was elected deputy chairman, with UNESCO representative Salem Hassan and IUA representative Françoise Lombard, present. Seven out of nine jury members were present at the first sessions – Charles Correa, an architect from India, and Pedro Ramirez Vasquez, a Mexican architect, having not participated. Two deputy jurors, Jan Meissner and Ahmed Helal then became voting members in accordance with the competition rules.

Jury Procedures

The International Jury carried out their tasks for the selection of the prize winners. Their diligent work resulted in a short list of finalists. Finally, the three prize winners and honorary mentions were selected. UNESCO representatives also witnessed jury deliberations issue the final report, and the announcement of the Competition results on 25 September 1989.

During the first days, the Jury reevaluated all Projects that the Technical Committee judged as insufficient or not complying with regulations. The Jury then analyzed the remaining Projects on the basis of the following criteria:

1. Position in relation to the skyline
2. Architectural form
3. Physical layout
4. Economic feasibility
5. Symbolic representation

The Projects were short-listed to forty-five entries. The Jury then examined these Projects in greater detail, mainly with respect to their functionality, and subsequently selected twenty Projects as eligible for awards. The Projects that did not comply with the program regulations were set aside at this stage.

An indicative vote was taken to determine those Projects, which merited prizes.

- Four Projects received more than four votes: Nos. 46, 57, 90, 252.
- A second vote determined that Projects 46, 90, and 252 would receive the first three prizes.

The Jury required an additional two days to write the report, open the envelopes and identify the Project architects before the public announcement on 25 September 1989 in a meeting under the auspices of Mrs. Susan Mubarak at the Alexandria International Conference Center.

Competition Results

First Prize	Snøhetta a.s., Norway
Second prize	Manfredi Nicoletti, Italy
Third prize	Fernando Ramaz, Brazil
Special Mentions	13 Projects
Special Merits	18 Projects

Jury Report

The final vote was as follows:

- Project No. 90: 5 votes
- Project No. 252: 3 votes
- Project No. 46: 1 vote

The vote for the second prize was:

- Project No. 252: 6 votes
- Project No. 46: 3 votes

The Jury declared:

- First Prize No. 90
- Second Prize No.252
- Third Prize No. 46

To select the Honorable Mentions, the Jury reexamined the forty-five last selections. After discussions and votes, a list of 13 Projects were drawn up:

Nos. 23, 25, 57, 72, 84, 99, 166, 209, 387, 406, 426, 479, 491

To give credit to the wide range of architectural directions, the Jury decided to nominate eighteen Projects for Special Merit, including one, which did not comply fully with the program regulations;



The Radiant Light of the Rising Sun

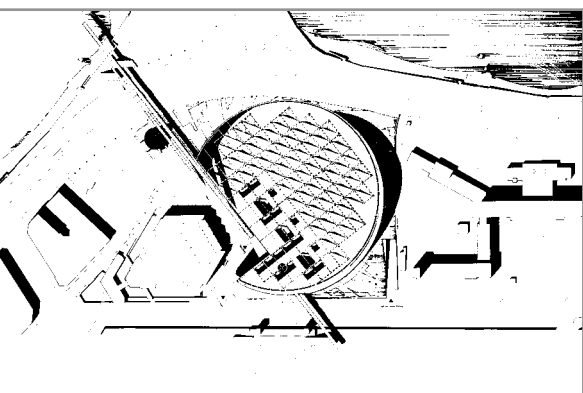

Site Plan

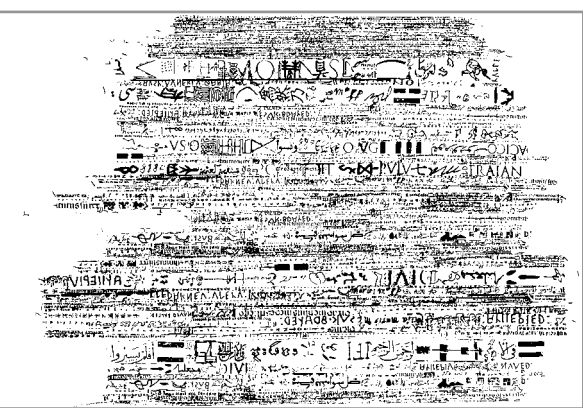

Detail View of the Exterior Wall Scriptures

Nos. 49, 55, 139, 141, 154, 189, 199, 207, 221, 227, 343, 357, 374, 377, 460, 475, 572, 585.

Main Jury Considerations

The Jury was sensitive to the enormous amount of research and analysis undertaken by all of the entrants to the competition and to the high quality of most of the designs and presentations.

In addition to a well functioning modern library, the Jury's main concern was to select a Project with a strong symbolic image. The symbolism was to express the roots of Egyptian civilization turned toward the Mediterranean world, and to the future.

The challenge to architects was, to give a striking, modern interpretation of a public building, at the same time, to take into consideration the permanent characteristics of the area, as well as the functional and spatial accommodations.

The First Prize: Project No. 90 by Snøhetta a.s., Norway

When the Jury examined all the 524 designs, there was one design that consistently commanded attention and received the most votes.

- The design was a circle inclined towards the sea, partly submerged in the ground, the image of the sun, illuminating the world of human culture.
- The Library is a cylinder, one simple volume, sheltering all the Library functions and activities, and complementing the Conference Center, an existing strongly expressive building at its side.
- An inclined roof that brings in light and offers views of the sea from the interior.

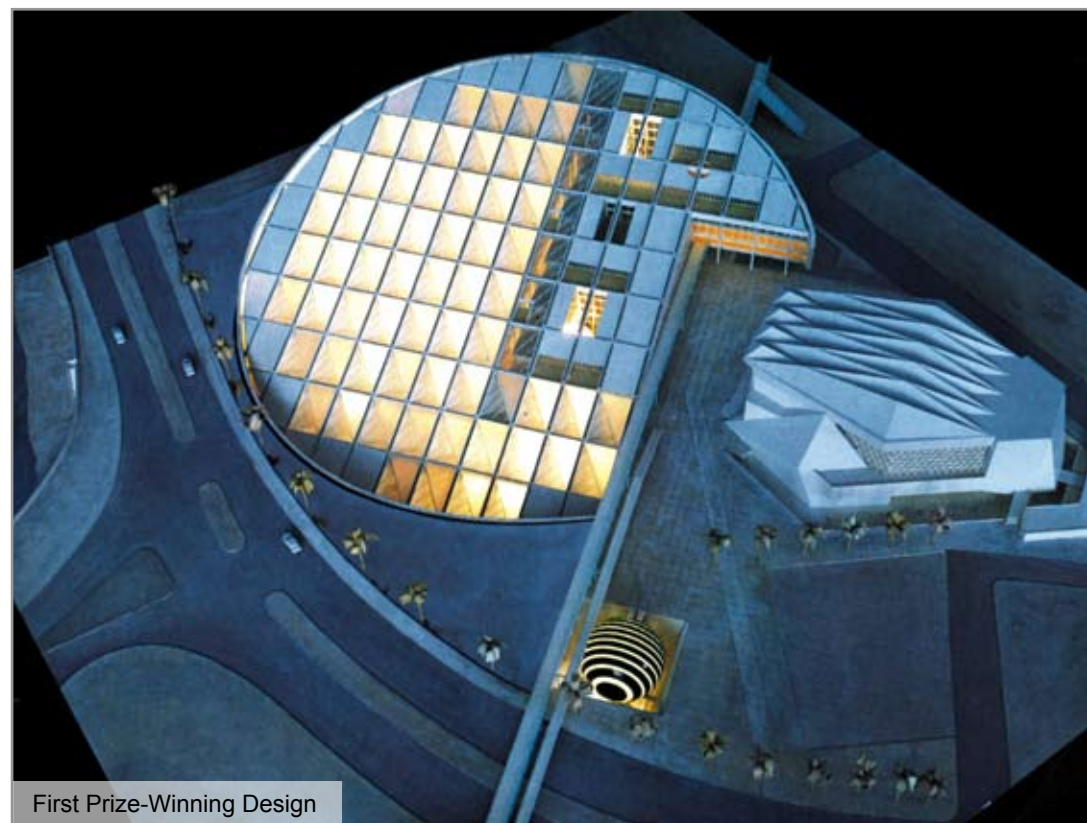
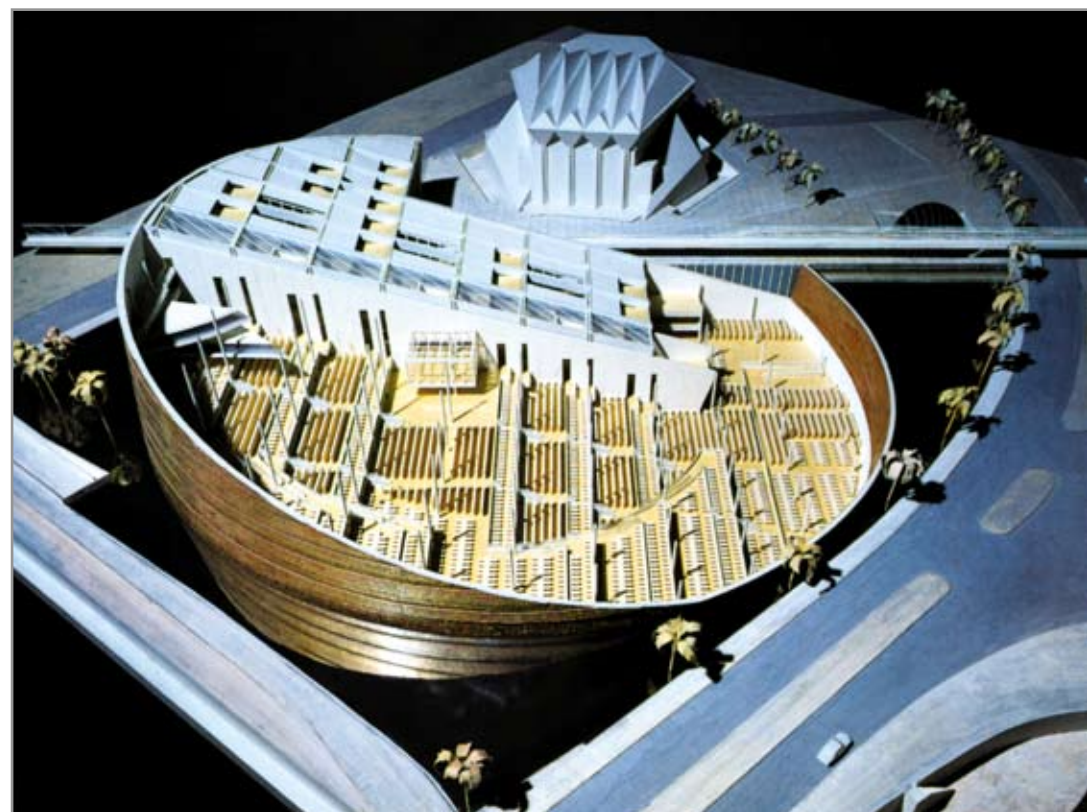

First Prize-Winning Design

- Once inside, the building offered staff and users a new concept of the Library's physical layout and organization.
- Cascading levels of platforms contained within this single volume, illuminated from the roof, provide a uniform ambience throughout the various sections of the Library.
- A technical spine serves the different platforms.
- Each level allows access to its own closed stacks, providing flexibility.
- Huge stepped reading halls provide a certain degree of privacy yet openness and universality of space, and offer access to handy stacks.

Comments of the Jury

- The tilted circular form offers the most dramatic and legible image from all directions, particularly the seaside.
- The Project excels in its bold concept and inspiring idea. The decision of using the circle as a symbol of unity and completeness was manifested in a new, strong and inspiring manner.
- The rising cylinder with sloping, articulated roof pays respect to the immediate site, the Eastern Port and to the socio-cultural environment.
- It gives this unforgettable impression, just like the Opera House in Sydney, Australia.
- The Building faces the harbor and visually counterbalances the Qaitbey Fortress diametrically across the distant barrier of the Eastern circular Harbor.
- The design also reacts with the climatic influences in a very scientific and strategic manner.
- The bold cylindrical wall clad with stone stands as a frontier protecting the building from the south sun, and the desert beyond.
- The interior functional organization is simple and clear. The interior space under one great roof offers a sense of exhilaration. The huge public space, cascading platforms and efficient distribution system provide the perfect environment for readers.



Meeting of Snøhetta with National Experts

This design continued to stay on top of nearly every secret vote taken during the last two days of the Jury deliberations when the final designs were subjected to criticism and careful appraisals. The winning design was not only an excellent masterpiece, but also a strong symbol of the New Library.

The Second Prize: Project No.252 by Manfredi Nicoletti, Italy

The second prize went to a design which captured the imagination. It was called: “A Citadel of Culture”.

- The design provided a continuous and uninterrupted building network, following an ancient Mediterranean typology. It is modulated on a square pattern structural grid. The entire functional system had a strong compactness derived from a continuous network of building.
- The design followed specified site and functional requirements. The massive design punctuated the shoreline and provided for a strong presence, which would be observed from many points along the Corniche and from other parts of Alexandria.
- The designers were cognizant of the fact that the location of the site near the sea provided negative and positive aspects. The low building network protected the Library from the strong winds of the sea and the noise of the Corniche.
- It also acted as a continuous wall and as a podium for the two dominating volumes visible from a distance, the Ptolemy Hall and the Main Library.

Comments of the Jury

- Among all the entries, this is certainly the most elaborate Project, “ready to be built”, as the jury mentioned.
- A strong image unusual to the Alexandria skyline is given by the Library building.
- A strong massive, truncated cone, is complementary to the mass of the Conference Center.



The Third Prize-Winning Design

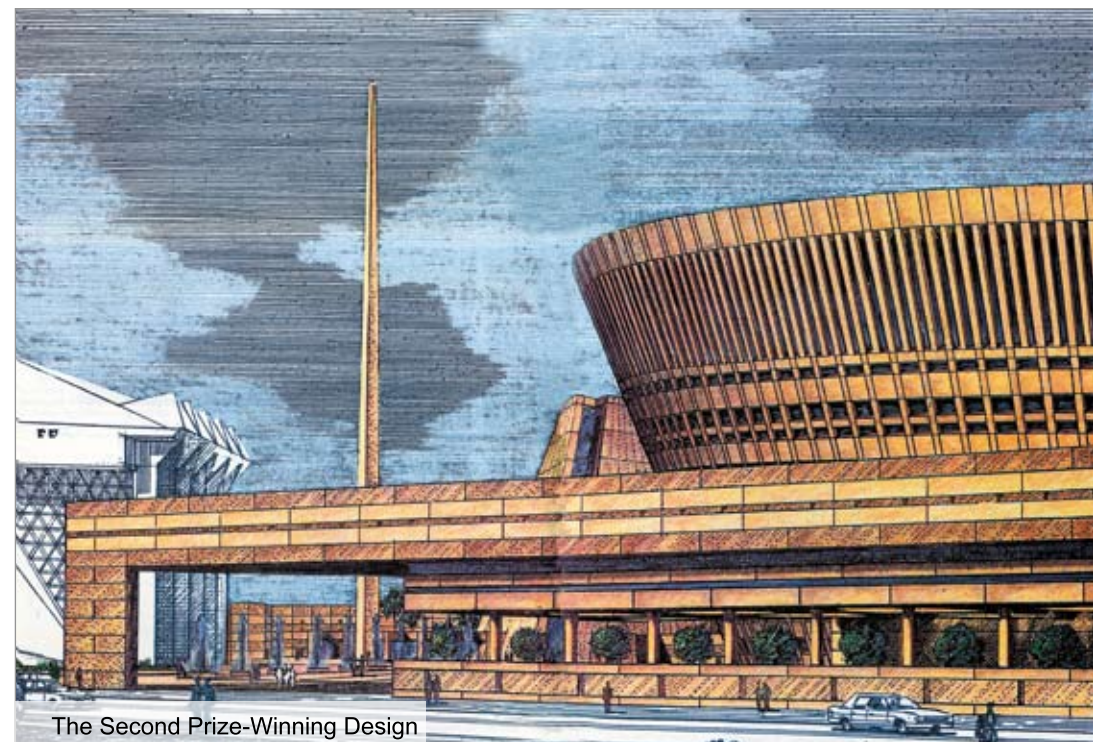

The Second Prize-Winning Design

- Surrounding the cone, lower buildings designed on a modular basis shelter the cultural facilities and organize the site in relation to the neighboring environment.

The main criticism of this Project is that it left no room for flexibility or imagination. It lacked uniqueness or a specially creative schemata.

The Third prize: Project No. 46 by Fernando Ramaz, Brazil

Among the different directions of architectural thought and style encountered in the competition, this Project is most representative of a modern approach.

- A grid-patterned wall, somewhat opaque, somewhat transparent, surrounding the entire site, gave a sense of unity to the Project, but left the Conference Center separate.
- The building, at a comparatively low elevation of three floors, organized the site along the north-south direction, leaving between them exterior spaces in relation to the interior.
- It had very strong public access links from Port Said Street and the Corniche Avenue directly to the middle of the site.
- Among the different directions of the architectural thought and style encountered in the competition, this Project is the most representative of the modern approach to contextually.
- General and detailed layout appears satisfactory in respect to the various functional requirements of the program.
- As a counterpart, the Project lacks a strong, identifiable image of the many different directions of architectural thought and style that prevail in the world today.
- The design of the Project No. 46 best represents an approach to regionalism or an abstract approach to contextual design, as it might be embodied in the 20th century in the context of a specific historical place.

Comments of the Jury

- It has an excellent plan, well organized and meets all the program requirements.
- It works very well as a library.



Competition Award Ceremony

- It incorporates all functions in only three main floors plus a basement floor.
- There is a wall surrounding the entire Project that opens or closes, depending on the precise function behind it.
- On each level, where there are stacks, the walls are solid. The wall opens on the third floor, where there are rooms with large windows, with open spaces or gardens. Where there is a large garden on the ground level, the wall opens onto its entire three-storey height.
- The overall design could be placed either in a desert location, or overlooking the sea.
- It has a sense of romance, a sense of unity.
- Over all, it is a unique design in character, it works well with the Conference Center.

Jury Concluding Report

The Jury Chairman, John Carl Warnecke (President of the UIA) wrote the following report on the selection process and the award:

Due to the fact, that the image of the Ancient Alexandria Library was not found or no remains of it to be allocated, the new image of the modern library, should be considered a rebirth or an entirely new entity. It was decided, to construct it, in the same location of the ancient Royal quarters of the Ancient Library.

“And as the Pyramids have become the symbol of ancient Egypt, the New Bibliotheca Alexandrina will be the symbol of the modern Egypt of today. The Jury examined all of the 524 designs that were submitted. There was one design that consistently commanded the attention of the jury. This design received the most votes on the first secret ballot of 45 entries that remained after a two-day process of elimination. This design continued to stay on top of nearly every secret vote taken during the next two days, when the final designs were subjected to vigorous criticism and careful appraisals.”



Project Discussions

Seminar on Project Evaluation and Criticism: held at the Palestine Hotel on 3 May 1990

Due to criticism voiced in the national media a seminar on the Competition and the awards was held at the Palestine Hotel in Alexandria on 3 May 1990. The seminar was held for the purpose of discussing the criticism leveled at the first prize design to prepare for the contract negotiations with the designers. It was chaired by Dr. Fathi Sorour, Minister of Education, and President of the Egyptian National Commission of UNESCO, and attended by Mr. Thomas Keller, Assistant Director-General of UNESCO, Mr. Francois Lombard, member of IUA and rapporteur of the jury of the International Competition, Prof. Dr. Mohamed Sayed Abd El Fattah, former President of the University of Alexandria, Ministry officials, professors of engineering and architecture, as well as the Snøhetta team. In addition, other prominent professors of civil engineering and architecture from Cairo, Alexandria and Ain Shams Universities also participated.

Criticism and the Designer's Answers

Various critical viewpoints were expressed both vocally and in the media:

1. Criticism was built upon the fact, that the building was built 16 meters below ground level, and based on that, the level of the basement would be located around 10 meters below sea level, and thus a possible threat of water leakage might occur inside the Library. (This was answered in the Preliminary Design Review (PDR) published in 1991.)
2. The second criticism was, that the Library is a closed cylinder, therefore it does not allow for a future expansion of the Library. Also, the circular roof is not complete, thus denying the notion of the full circularity of the rising sun or the microchip form. (This was professionally explained to the meeting by the Designers.)
3. The roof as it appeared in the newspaper pictures seemed to be transparent, thus, it would allow sunlight inside the Library. This direct sunlight inside is not fit for reading and research functions, and thus the design is not suitable for the design requirements, as set in the brief. (This was denied by the designer, and further explained.)
4. Criticism was voiced concerning the neglect of using the roof as a missed opportunity as a source for solar energy. (This proposal was mutually laid to rest due to technical explanations.)

5. The design, being too modern and “too Nordic” does not pay homage to the Egyptian heritage and culture. (This was properly defended by the architect.)
6. The proximity of the Library location to the electric tramline, which is nearly about 150 meters away from the Library, might cause the tramline electric current to be transmitted through earth to the Library foundation, which may cause rusting of the steel reinforcements. (This was discussed as baseless.)
7. The various Library functions were placed in one great reading hall, and this design does not offer the necessary quiet atmosphere, and that the noise and acoustic problems would necessarily occur, since the cascade of levels inside the great universal space of the Library, would allow the transfer of noise from one level to another, thus causing distraction and lack of concentration of the readers. (This was defended as functionally necessary.)
8. The eighth criticism was that too many book storage areas were located below ground level, and this requires that the Library should be fully air-conditioned and that it would cost a great deal to maintain and operate. (This was properly defended.)
9. The ninth criticism was that the outside wall was completely solid, and that it does not allow for any openings or windows for natural light, as well as visual access to the outside wall. (This was properly defended.)
10. An important criticism was expressed to the designers regarding the illegible architectural expression of the library main entrance from the plaza. The lack of control of accessibility to the plaza was also a source of concern.

There were other prominent personalities and faculty members from Cairo and Alexandria, who viewed the Project and the competition exhibition and testified that the Project had very positive creative aspects, which placed it at a high rank far beyond the level of the other competition designs, and that the first prize design was truly the best of all the designs submitted in both creativity, originality and functionality.

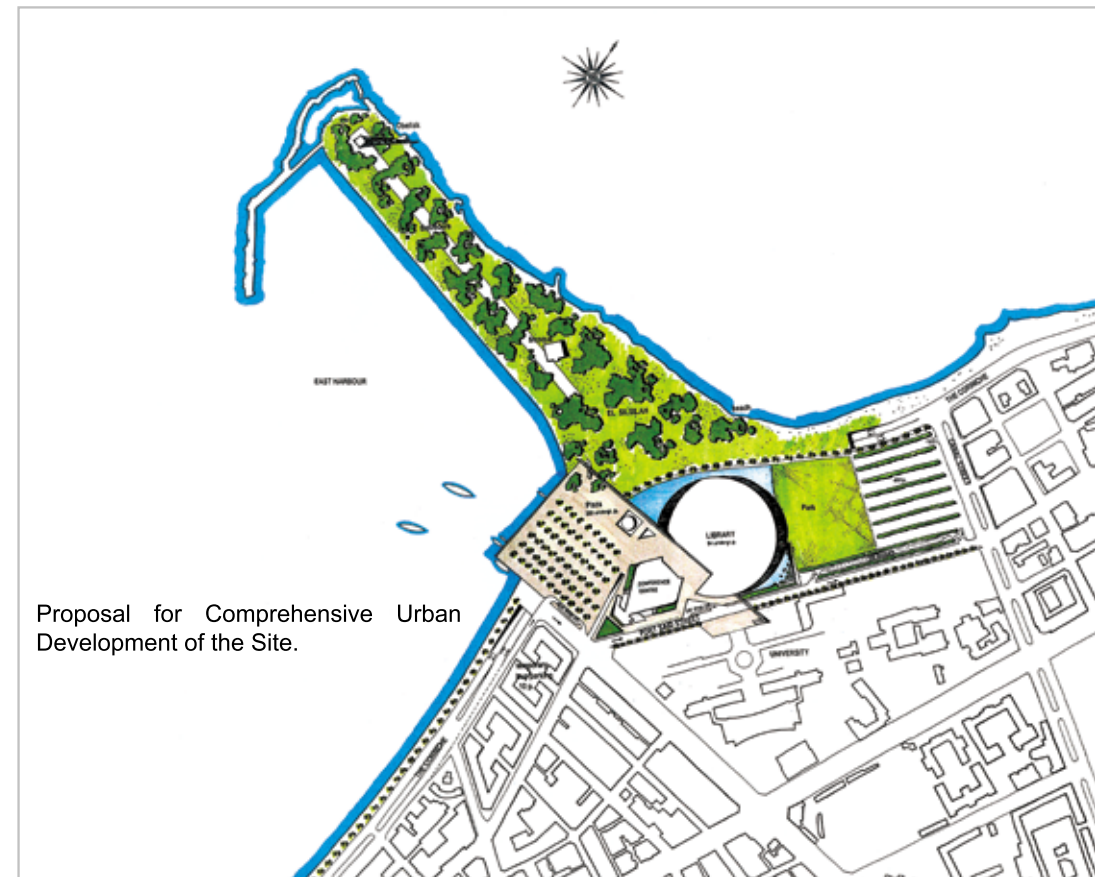

During the review process there were comments regarding some modifications concerning the Preliminary Design Review (PDR):

A) Site

- There was a discussion of the possibility of decreasing the radius of the circle to 150 meters to achieve a larger distance from the Corniche and Port Said Street, and to give a better relationship between the building mass and the surrounding area.
- Shifting the building towards the hospital building, but keeping a minimum distance, would enlarge the plaza between the Library and the Conference building.
- Modification of the Library building-edge located on Port-Said particularly the right angle façade of the Conference building.

B) Building

- In general, the drawings are not clear enough to indicate the number of levels below ground level i.e. in the Competition 8 storeys, in the PDR progress report four storeys on 7 December 1989, and in the PDR progress report five storeys on 5 January 1989.
- The possibility of raising the whole building was recommended to minimize the number of floors below ground level particularly that the PDR progress report on 5 January 1990 indicates the presence of five storeys below ground level which contradicts the comments of the jury.
- Investigation of the possibility of introducing some openings in the solid external wall to achieve a better visual aspect between the internal space and the exterior. These openings could be introduced within the Calligraphy pattern and form.

C) Drawings

It was recommended to provide:

- Detailed drawings for the Planetarium since the whole submitted drawing and the PDR progress report does not include any details concerning this building;
- Information applied on drawings showing compartmentalization concerning fire, smoke detectors, double doors, and screens;

- Additional information concerning the fire escapes in the double wall;
- Additional information concerning the engineering services, i.e. air-conditioning, electrical sanitation, mechanical conveyors for books, at least locations of vertical and horizontal ducts, on drawings sections and plans;
- More details concerning the acoustical treatment of the ceiling.

All these comments and criticisms were largely taken into account in the *Preliminary Design Review* (PDR) submitted to GOAL in 1991. The designers also included the required revisions and suggestions whenever possible in their preparations and negotiations towards the contract for the design of the building. Criticism and regular review of the design were actually an on-going process throughout the design period, and extended into the construction phase.

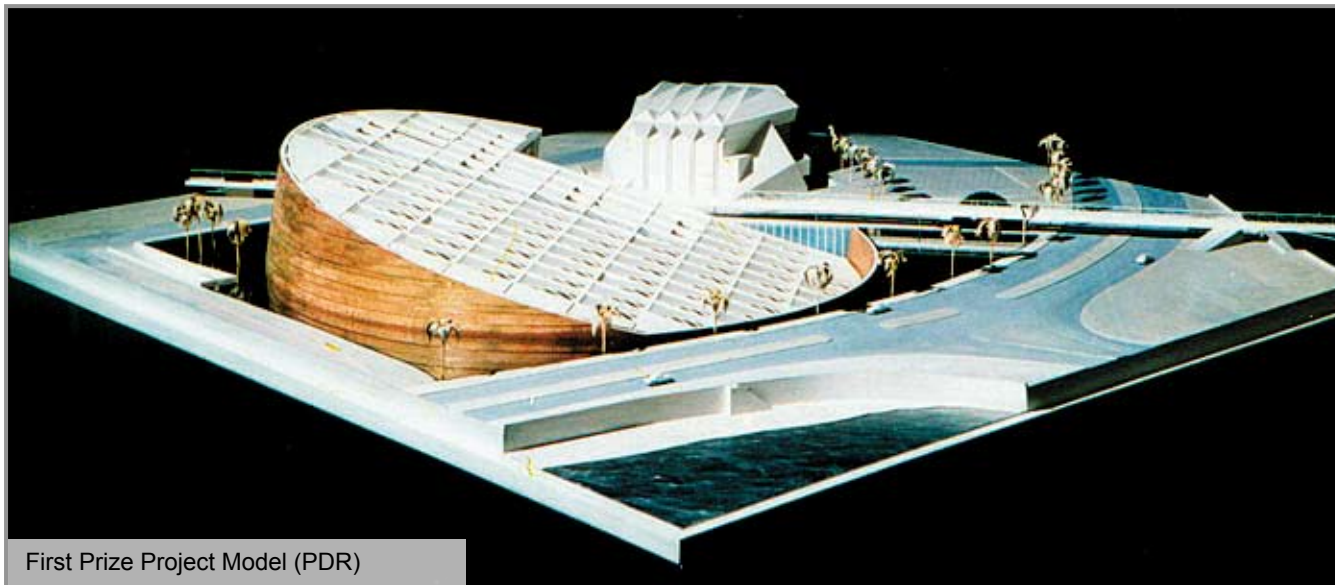



“ Political ideologies might separate countries, and economic interests may cause gaps among people, but culture alone is a unifying rather than a dispersing element. Human knowledge, which is the treasure from which we pay our contribution today, is the credit to our future.”

Mrs. Suzanne Mubarak,
Chair of the International Commission, at Aswan
12 February 1990

CHAPTER 5

CHAPTER 5

THE ASWAN MEETING OF THE
INTERNATIONAL COMMISSION



Aswan Meeting of the IC

The historic city of Aswan has been linked for years with great achievements concerning cultural heritage as a result of the support of the international community, such as the salvation of the great Temples of Ramses at Abu Simbel, the saving of the Temples of Kalabsha and Elephantine Island from inundation by the rising Nile water in Lake Nasser following the building of the massive Aswan High Dam.

On 12 February 1990, a historic event of no less importance took place, which the entire cultural world watched with enthusiasm and interest. The occasion was the Inaugural Meeting of the International Honorary Commission for the Revival of the Ancient Library of Alexandria, chaired by Mrs. Suzanne Mubarak and honored by the presence and patronage of H.E. Mr. Mohamed Hosni Mubarak, President of the Arab Republic of Egypt.

Participating in the meeting were, Kings, Queens, Presidents, Princes, Princesses, Prime Ministers, Ministers and notable dignitaries in the fields of science, literature and art, who gave generously of their valuable time and effort. Mrs. Mubarak, the First Lady, was consequently chosen to chair the International Commission (IC) for the Revival of the Bibliotheca Alexandrina. Distinguished international personalities from various countries were enlisted as members of the International Commission to boost the unique and special support required for the tremendous undertaking ahead by international governmental and non-governmental organizations, public and private, institutions, as well as for all the efforts initiated by the Egyptian Government to make the Aswan Declaration succeed.

The schedule was planned over two days to include a welcome speech by President Mubarak, time for socializing, and then the meeting with the International Commission members. The national and international press, including the television, covered the event. Kjetil Thorsen, Christoph Kappeller and Craig Dykers, the architects, were also invited there to respond to any queries concerning their design. Mr. Thorsen and Mr. Dykers explained to some of the participants and guests during this historic day the symbolism of the building and the appropriateness of the design for the location and for the concept of the Revival Project.

In this remarkable meeting, President Hosni Mubarak gave his historic address reminding the world that “not on bread only does man live”, and urged them to join Egypt in rebuilding the Bibliotheca Alexandrina.

The meeting of the International Commission gave a chance for each member of the Commission to voice his support for the Revival Project, and to sign the historic “Aswan Declaration”. They rallied in praise of Egypt’s cultural heritage and contributions to world civilization, especially through the eminent and unprecedented role of the Ancient Library of Alexandria.

Members of the Commission declared to the meeting, and through the media to all people in the world, his/her unflinching support of the Library of Alexandria Project. They reiterated their pledge and commitment to spare no effort or time to work individually and in concert toward the ultimate realization of the Bibliotheca Alexandrina.

- Mrs. Suzanne Mubarak gave the opening speech to the meeting, welcoming the dignitaries, stressing the objectives of the Library and emphasizing the need for international cooperation, involvement and commitment.



IC Meeting at Winter Palace Hotel, Aswan



President Hosni Mubarak and El-Sheikh Zayed



Aswan Meeting



Aswan Meeting

- As for highlighting the ceremony, President François Mitterrand gave the keynote speech and indicated his great pleasure and high esteem to participate in the Aswan Meeting, and pledge France's technical support of the Project. He had earlier requested the French Government in the late 1980s to build the great French Library "comme la Bibliothèque d'Alexandrie".
- Her Majesty Queen Noor Al Hussein of Jordan, made sure to be a co-promoter in this unique event. She urged the Royal Jordanian societies to donate books.
- Her Majesty Queen Sofia of Spain shared the fact that many Spanish institutions were supporting the Project already, as shown by the major donations of bibliographical material already announced by the Spanish Higher Council for Scientific Research.
- H.R.H. Prince Turki Ibn Abdel Aziz Al-Saud, the President of the Arab Student Aid International (ASAI) pledged and paid the donation of during the Inaugural Meeting of Aswan, for the sum of US\$ 3 million, which was a gesture of solidarity with Egypt.
- Princess Caroline of Monaco played an active role during and after the meeting.
- H.E. Mr. Yahya Bin Mahfouth Al-Manthri, Minister of Education and Youth in Sultanate of Oman, was participating in this event on behalf of his Majesty Sultan Qabus Ibn Said, who pledged US\$ 1 million and nearly 10,000 books specially acquired for the Library from Europe and shipped to Egypt. These were transferred to the Library in 1999.
- Mrs. Gro Harlem Brundtland from Norway, member of the Parliament reaffirmed the support and commitment of Norway to the Project realization.
- Dr. Hans-Peter Geh, President of the International Federation of the Library Associations (IFLA), expressed commitment to the Project in his speech at the opening of the 54th IFLA General Conference in the Opera House of Sydney in August 1988, and stressed need for dedication and support of the library world for the New Bibliotheca Alexandrina, as a future universal treasury of knowledge serving the region. Dr. Geh was invited by the ES as a UNESCO expert several times to provide in-house training to the librarians and later became a member of the Board of Trustees.

- President Mohamed Hosni Mubarak gave the closing speech, declaring his highest appreciation and thanks for their support for this great cultural and humanistic Project and thanked all the participants of the meeting on behalf of Egypt, for their noble participation in the Revival of the Library of Alexandria.
- Mr. Daniel Boorstin, Librarian of the Library of Congress and Federico Mayor, Director-General of UNESCO both spoke publicly in favor of the Project.

The meeting resulted in a massive unprecedented donation from Arab countries of US\$ 65 million. This catapulted the Project to the arena of realization and implementation. Those donors are gratefully acknowledged in a plaque in the Library entrance hall, along with other important donors, as the “founders” of the New Library of Alexandria.

THE BIBLIOTHECA ALEXANDRINA

Gratefully acknowledges the generosity of

The Donors of Aswan (1990)

Iraq

Saudi Arabia

United Arab Emirates

Oman

The US\$ 65 million were pledged by Iraq, Oman, Saudi Arabia and United Arab Emirates within 24 hours after the proclamation of the Aswan Declaration and this was the actual estimated cost of the building at that time. Indeed, it was a glorious beginning to the fund-raising drive to raise US\$ 150 million to meet the cost of the construction of the prize-winning design of the International Architectural Competition, and to cover the cost of the equipment, collection acquisitions and the training of the Library’s human resources.

President Mitterrand was particularly moved by the concept of reviving the Ancient Library. He promised that France would be a sincere supporter, and in fact has been so. When I was invited by Sheikh Zaid bin Sultan Al Nahyan to meet him at his chambers at the Winter Palace Hotel, I was impressed by his simplicity, generosity and graciousness. I thanked him from all my heart for his contribution that inspired and motivated other donors.



IC Members at Aswan

The Aswan meeting and the “Aswan Declaration” immediately attracted the attention of people all over the world. Donations, large and small, financial and in-kind, began arriving at the GOAL office in Alexandria. The staff did their best to organize the work, acknowledge the gifts, and prepare for the work ahead. Individuals from Egypt and around the world began to write their support to the Project. On the other hand, the admiration and acclaim expressed by the dignitaries concerning the prize winning design was a vindication and confirmation of the Jury decision. It also served to muster great support from Egypt and abroad and was overwhelming in dissipating any criticism or resistance due to one reason or another.

The meeting was the actual launching pad of the Project before the public. Since I was Director of GOAL I also began to speak at citizen’s groups, to business clubs and others around the country to mobilize their interest and support. I attended and gave nearly 100 speeches in lectures, seminars, conferences and meetings in Alexandria, Cairo, Abu Dhabi, Ankara, Athens, Manama, Damascus, Essen, Fez, Frankfurt, Geneva, Istanbul, Kuwait, Limasol, Limoge, London, Madrid, Marseilles, Naples, New York, Oman, Oslo, Paris, Palermo, Peking, Rabat, Riyadh, Rome, Seville, Shanghai, Tunis, Valencia, and Zurich. The intangible and tangible results were certainly enormous, breathtaking and truly gratifying.



Aswan Meeting



“ You can spend all your money on roads and housing and on the poor, but in the end you simply find yourself needing more money. Real civilization always starts in the mind. It is ideas that make life grow green. Even our greatest problem, arresting population growth, is a matter of ideas. If we do not have them and cherish them, we shall be tied forever to the wheel of circumstance. I think the Bibliotheca Alexandrina will be a beacon of ideas for peoples like us all over the world.”

Mohsen Zahran, in The Guardian (quoted in “Potent Quotes”,
www.dhurley.com/quotes.htm)

CHAPTER 6

THE TORCH CARRIERS:
THE GENERAL ORGANIZATION
OF THE LIBRARY OF
ALEXANDRIA AND THE
EXECUTIVE SECRETARIAT

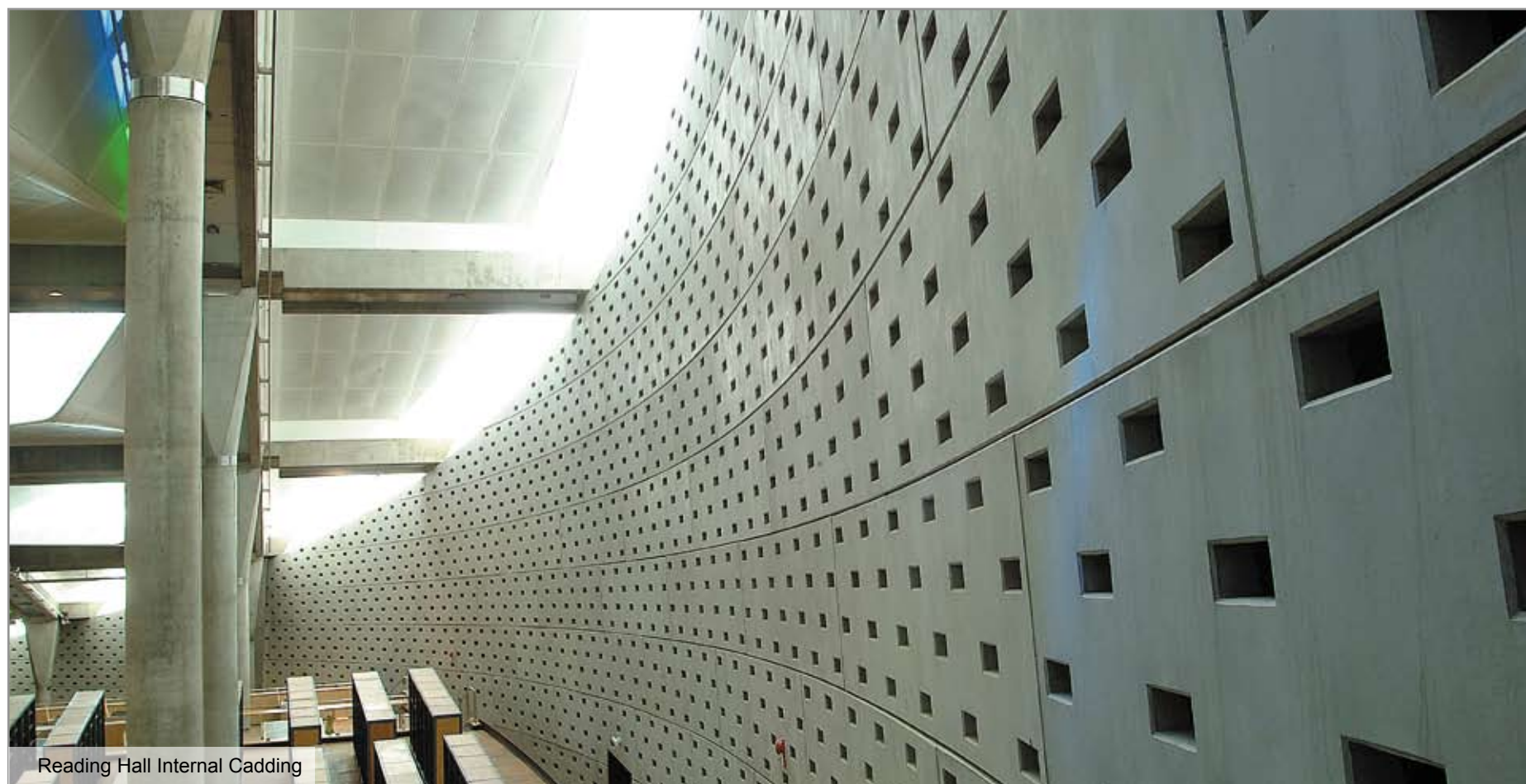

Reading Hall Internal Cadding

When Egypt committed itself to the Revival Project in 1985, it became necessary to develop a governmental body that could oversee the implementation of the program. The Preparatory Committee of the University of Alexandria established by the University Presidential decree 365 on 27 April 1985, was consultative in nature to the General Organization for the Alexandria Library that was established by Presidential Decree No. 523 of 1988 to be the executive official machinery for implementing the Project in cooperation with UNESCO. A Ministerial Decree nominated me as Director, under the chairmanship of the Minister of Education.

The Board of GOAL was chaired by the Minister of Higher Education, and its members included several ministers, the Alexandria Governor, the University of Alexandria President, and some important public personalities (see Appendices). Each member had an important role to play in the development of the Project. Dr. Sorour was instrumental in proposing and securing the issuance of Presidential Decree no. 206 in April 1990 allocating the site and the Conference Center for the Project implementation.

The Board met twice. The first board meeting was held in Alexandria on 26 August 1989 to launch GOAL, approve the competition procedures, and adopt the media and public information drive for fundraising. The second meeting was in Cairo on 23 September 1990 and it was decisively important since it approved some important resolutions for the work ahead. These included:

1. The GOAL Board resolved to accept the donations of US\$ 65 million contributed by the participants at the meeting of the International Commission in Aswan in February 1990.
2. The Board resolved that the budget accounting for these donations would be assigned to GOAL to spend on the execution of the building Project.
3. The Board resolved to approve the results for the International Architectural Competition and the conclusions of the Seminar at the Palestine Hotel on 3 May 1990 that were accepted by the First Prize Winner. It also resolved to approve the beginning of negotiations with the First Prize Winner to prepare the Design and Engineering Contract.
4. The Board approved the draft Project Agreement with UNESCO after the inclusion of certain changes. The changes included that GOAL be the official representative of the Government of Egypt wherever it was mentioned in the Agreement. It authorized the Minister of Education to sign the finalized Project Agreement with UNESCO during the forthcoming UNESCO General Conference held in Paris in October 1990.
5. The Board resolved to adopt the University of Alexandria bylaws for GOAL, and gave the power of a university president to the Executive Director of GOAL. This was reaffirmed by the Minister of Education (Moufid Shehab) later.

I worked from home until the University agreed to provide me with office space so that I could begin hiring supporting staff. This was important since as soon as the first “Appeal” was issued by UNESCO, GOAL began receiving book donations from governments around the world. We needed a place to receive and process these donations, and a place to store them. The nucleus of thirty staff members covered administration, finance, engineering, and library tasks were led by the Administrative Head, Mr. Salah Ziada (1990-1998) who was succeeded by Abdel Latif Hassan (1998-2001). Both were seconded by the University of Alexandria Administration to work for GOAL. The Ministry of Finance also appointed a Resident Director to control and audit GOAL’s financial affairs.

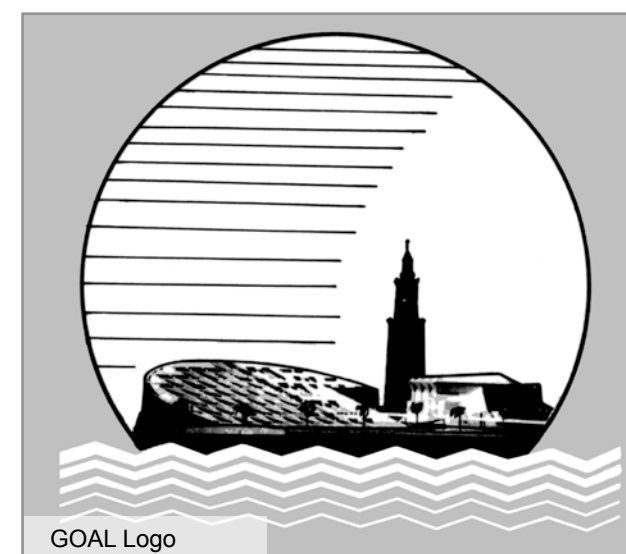

In the meantime, the Executive Secretariat (ES) was established according to the Project Agreement between Egypt and UNESCO signed on 26 October 1990 and approved by Presidential Decree No. 36 of 1991. The working arrangement between GOAL and UNESCO, stipulated that the Project Manager would be a UNESCO civil servant, and the Deputy Project Manager and the pertinent staff would be provided by Egypt. The governing bodies that would oversee the Project development comprised the International Commission (IC), the International Executive Committee (IEC) and the Executive Secretariat (ES). The International Commission had already been established at the time of the Aswan meeting, and this was confirmed in the Project Agreement. Subsequently, the Seat Agreement was also signed between Egypt and UNESCO on 1 November 1993, and was approved by Presidential Decree No. 94 of 1994. Both Agreements were approved by the Egyptian Parliament and thus acquired the powers and authority of laws of the land.

It took some time for the governmental wheels to begin to turn. I was fortunate to have the opportunity to meet Mrs. Mubarak again in 1991, this time at her residence at Heliopolis in Cairo, to inform her about the progress of the Project, and engage her support. It was at this time that she contacted governmental officials to prepare a 5 million Egyptian pound allocation for GOAL.

After securing proper government support for the GOAL operations, an immediate search began for new headquarters from which the Project could be administered. A new building in Shallalat was being built at the time, and a decision was quickly made with the Minister of Education to purchase the premises there. I was able to acquire the entire fourth floor of the building – actually the equivalent of ten apartments - to house the GOAL and ES staff. The parking spaces in the garage were sold separately from the housing units, and we could not afford this extra cost. However, I used my contacts and credit with one of the owners, who was a former client of mine, in the building to acquire five parking spaces for the GOAL vehicles.

I personally hired a local contractor to redesign all the floor to provide offices, work rooms and as much storage space as possible. This was finally completed in Fall 1992. At the same time, preparations were made for the new ES staff to have offices there. The first UNESCO Project Manager moved to Alexandria in February 1992 to set up his offices, and also began his search for staff with my help. He shared my office space on the fourth floor above the Central Scientific Library at Chatby. The new facility also allowed GOAL to begin the implementation of its Human Resource Development Program by hiring librarians, administrative, technical and financial officers and supportive staff.

Giovanni F. Romerio, a UNESCO civil servant, headed the ES from February 1992 to June 1995, and I was appointed the Deputy Director during that period. He had been partly involved in the Project from the UNESCO side since 1988 and was keen to pursue the fulfillment of UNESCO's obligations and requirements for the implementation of the Project. After his arrival from Paris, Mr. Romerio began his search for staff and we were fortunate to find suitable senior Egyptians to fill his key positions.

Ali Osman, former Governor of the Red Sea, became the Head of Administration and Finance, and Mr. Mohamed El Turgoman, former senior census administrator in the governmental administration, took the position of Controller. They assumed their positions when we moved to the new premises in August 1992. A few months later Mrs. Layla Abdelhady, a former librarian at the American Center, was enlisted as acting Deputy Head of Library Services, and Mr. Mohsen El Zayat as Head of the Construction (1993-1995). These personnel, along with the principal secretary, Mrs. Laila Dowidar, and Mr. Mostafa Abdelaziz, accountant, became the backbone of the ES. Dr. Romerio retired from his post in June 1995. Mr. El Zayat left the ES at the beginning of the Phase I construction in 1995 and his duties were assumed by the Construction Monitoring Unit (CMU).

The ES oversaw the implementation of the Project for UNESCO, which represented the international community. It was able to manage the disbursement of the international funds provided through the UNESCO grants and to monitor the Project through the IEC. After the Seat Agreement was signed on 1 November 1993, UNESCO opened a special bank account for the ES and transferred funds there to facilitate payments for services.

UNESCO and the ES worked closely with the International Friends. UNESCO had appointed a liaison officer to help establish Friends Associations in their member countries. Naturally, UNESCO wanted to interact with the ES, its counterpart in the Project. I always felt that the International Friends should work directly with GOAL, since the Library was a national institution and they would continue as Friends Associations after the inauguration. I, as the Executive Director of GOAL, was appointed by the Ministry as the official representative to attend the international meetings and



Zahran and Romerio



ES and GOAL Staff

also appointed as national Project officer concerning the UNDP grant. UNESCO's liaison officer also attended these events. Excellent and long lasting relationships were formed among us at these proceedings and I worked hard to encourage their full support for the Project, the New Library and eventually the inauguration.

Overseeing the UNESCO grants was more than just the financial accounting of funds. The grants also promoted some significant activities during this period. The ES prepared reports for the IEC meetings that recorded its activities and achievements. These were also passed on to UNESCO and to the Egyptian Government for their review. One of its significant achievements on a very tight budget was the first book catalog resource for book acquisitions. This was called "BIBALEX A" or "BIBALEX B". It included the usual information required in book catalogs such as name, author, and publication date. However, as the acquisitions increased in number it was soon found to be too small to achieve a good result. It was then that UNESCO was asked to donate its book cataloguing system (CDS-ISIS, for small libraries). The UNESCO system was supposed to be able to migrate its data to a larger system when that became available. It is important to remember that this was at the beginning of the technological revolution that quickly took the world by storm. There were no systems like this anywhere in Egypt at the time, and in fact it was planned that the Bibliotheca Alexandrina would lead the way for all libraries in Egypt and in the region.

The IEC was a body created in the UNESCO Agreement to oversee the implementation of the Project. The five Egyptian members were at a ministerial level, several international members also held high level governmental positions and others were professional librarians. All of them agreed that the future of the Bibliotheca Alexandrina would be a unique experience. Disagreement only arose sometimes on the methodology of some of the activities although UNESCO experts had prepared feasibility studies on collections development and ISIS. The IEC decided that the intellectual content should be given a special priority and thus a special sub-committee was created. It met several times in Alexandria, Cairo and Paris, and issued its recommendations to the IEC, which were adopted during the second IEC meeting.

The IEC met three times during the execution of the Project. Chaired by the Minister of Education, it held its first meeting on 26 June 1992 at the Alexandria Conference Center. Mrs. Suzanne Mubarak honored the meeting by presiding over the opening session to which she gave a memorable address urging the Committee members representing the international community and Egypt to spare no effort or time to start the execution of the Project and muster all resources needed to achieve this noble goal.



Follow-up Committee Meeting



IEC Meeting

The second meeting, under the auspices of Mrs. Suzanne Mubarak, met on 1 December 1993 at the Conference Center to review the progress, adopt the Project budget, work plan and the schedule of the Project implementation. It was chaired by a representative of the Minister, Fathallah El-Khatib, who had recently returned from his post as Ambassador to the Egyptian Permanent Delegation to UNESCO. It was an exciting meeting since the contract for the design of the building had just been signed in October and everyone was looking forward to the coming few years of work. The observers were from UNDP and the Egyptian National Commission for UNESCO. I represented both GOAL and the ES, and always prepared a report for the IEC. However, neither did I nor Dr. Romerio have a voting membership in this board.

The International Executive Committee held its third and final meeting on 5 May 1997 at the Conference Center and was chaired by the Minister of Higher Education. The Committee toured the construction site and all appreciated the progress achieved by the completion of Phase I (Foundations) and the ongoing work of Phase II (Superstructure) that began on 28 December 1996. I represented both the ES and GOAL at the meeting. Counselor Dakroury and Dr. El Khatib commented after the meeting that it was the best IEC meeting ever held.

One of the main items on the agenda for all the IEC meetings was the budget and the work plan. The Project budget was based mainly on the UNESCO grants that had been allocated to the Project. The work plan more or less followed the construction process, but also set objectives and milestones for the working of the future library. The budget provided spending plans for these grants according to the guidelines already determined for each grant. For example, the UNDP grant provided the first equipment for the new information system. This equipment was obtained to be used by the Project staff, and for certain GOAL staff members, especially the librarians. The information system itself (computers and server) was very modest if compared to current standards. Nevertheless, it set the Project in motion.

After Dr. Romerio's retirement in June 1995, I was appointed by the Minister of Education as the Project Manager from 1995 until 2001 when the construction work was completed. During this time, I also held the position of the Executive Director of GOAL. The bilateral management of the Project with both GOAL and the ES worked integrally as one body with two wings in full synchronization with each other.

The purchase of books for the New Library actually began in 1990 when I was able to hire my first staff. I gradually increased the volumes purchased to 30,000 per year, to reach the 200,000 volumes



Staff at Conference Center

promised for the inauguration. As a university professor, I was particularly aware at the time of the lack of modern library resources for my own students, let alone those from other faculties. I envisioned the Bibliotheca Alexandrina as the best intellectual and scholarly library in Egypt for modern science and technology and medicine, incorporating the interests of other students, scholars and public users. These purchases were generally made through the governmental organization, Al Ahram Distributors (a public sector serving the official establishment). This allowed official accounting transparency in the payment for books, made in Egyptian pounds, not in dollars or any other foreign currency which greatly simplified our financial situation.

Eighty percent of Al Ahram imports' is foreign books from international publishers. Annually, I attended the Frankfurt Bookfair held in October to choose and purchase books from international publishers. These purchases were made through Al Ahram because it was represented at the Frankfurt Bookfair. Since the Library was empty of books, Al Ahram selected books from every topic and category in cooperation with the Book Acquisition Committee created at GOAL with members representing the University faculties and specializations, which is also audited by the Central Auditing Authority.



Staff in the Conference Center Terrace

I worked closely with the ES and the Head of Library Services to prepare a proper collection development policy for both our acquisitions and the gifts arriving to the ES and GOAL offices. Early on, the Preparatory Committee, the Library consultants, and UNESCO had determined that it should concentrate on acquisitions covering the heritage of the Ancient Library, Alexandria and Egypt, as well as the Mediterranean Region and Africa. Bibliographies were constantly requested from our consultants, professional visitors, and from institutions cooperating with us that had holdings in these areas.

Cooperating with Al Ahram in this way had another benefit for the Library, since it provided space within its own exhibitions for a special exhibition of the Library achievements. Our own exhibition was designed around the best of the monthly pictures of the site work provided by the contractor. It served to keep the public aware of the Project activities. This publicity also alerted the international publishers represented at the bookfairs, especially at the Cairo Bookfair, and many of them donated their remaining books wholly or in part to the Library when the Bookfair was over.

The GOAL librarians represented the Library at the Cairo Bookfair. This was a real learning experience for them, and made them more aware of the breadth of international book offerings, and of the international standards they should be following. In many cases it was also the first time they had ever interacted with the public in such a way. They had to explain the concept of the Library, to discuss the construction that was being shown in the pictures, and they also had the task of identifying books at the bookfair that met the Library's collection development needs.

The GOAL and the ES worked together to establish depository agreements with certain United Nation agencies, the World Bank, the Council of Europe, UNESCO, the European Union and other institutions for receiving their publications. One of the first publishers to agree was EuroDimension, a Greek publisher of fine art books specializing in ancient Hellenic heritage. The Depository Library was originally housed in the GOAL extension offices at the Conference Center, next to the construction site.

GOAL and the ES subsequently worked to provide the Library professional staff with the necessary training, on the job, in local institutions or through scholarships abroad. The GOAL librarians had on-going training programs, by Egyptian, as well as by international experts. All the funding agreements, through UNESCO, had staff training as part of their budget allocations. This valuable resource was used to send about 50% of the professional staff on missions abroad for internships and training courses. In addition, certain intergovernmental protocols in the cultural field were established in cooperation



Cairo Bookfair

with the Ministry of Foreign Affairs that offered training, exchange of expertise and donation of Library materials through special governmental institutions, especially national libraries. For example, a protocol with the Italian Government provided training and a stipend for Library staff in Italy. The Italian Cultural Center in Alexandria supported this protocol by providing training for staff members in the Italian language so that they could function once they began their missions in Italy. The French Cultural Center, the Goethe Institute and the Spanish Cultural Center also provided language training for Library staff. The British Council offered free memberships to the Library staff to support their studies, and make use of the British Council's facilities.

GOAL was responsible for all the finances of the Project. This included the construction costs, the GOAL staff, and the seconded ES staff. Every six months GOAL had to prepare a budget for the Finance Ministry so that funds could be distributed to GOAL bank accounts to pay salaries, the contractors, and operations expenses. While estimating the budget for six months was sometimes difficult (construction costs were often hard to estimate), it required intensive contacts and negotiations with the Finance Ministry Departments, and the government central accounting offices, to ensure the money actually reached the GOAL accounts on a timely basis. Egyptian bureaucratic routines are still burdensome and personal contacts with the heads of various offices are often required to execute official orders. I had to use outside resources, and sometimes my personal funds, so that the staff, and sometimes bills, be paid on time. This is unheard of in regular circumstances but my commitment to the Project remained unswerving so much so that I could not do otherwise.

GOAL was also responsible for the Construction Monitoring Unit (CMU). The CMU assessed the implementation of contracts with the consultant and contractors. Its offices were at the construction site, not at the headquarters in Shallalat. It was coordinated and supervised by Dr Hisham Abdelmohsen and included a team of experts, engineers and technicians. Our engineers there had to ensure quality control and quality assurance of the construction activities; the actual building processes, and keep track of all the expenses by careful study of the Provisional Monthly Financial Statements (PMS) and claims by the contractors. They worked closely with the consultants and engineers to enhance designs to better suit the circumstances and needs of the Library.

By the time the Library was completed several design changes had been made. These involved floor plans and systems. For example, the excavations had left many open areas in the ground around the building and next to the Conference Center. I had these prepared as additional storage space. Eventually,

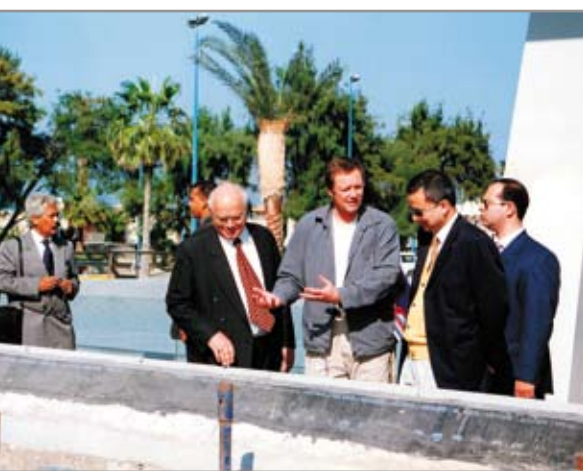

Visits by International Dignitaries

some of these spaces were converted to meeting rooms and links between the two buildings. We also redesigned the garage area next to the Planetarium for what is now the ALEXploratorium and added offices to the Conference Center.

The Project was hailed both nationally and internationally. It was considered an international model and cultural bestseller in design, engineering and construction. In Egypt, some were critical because of the money being spent, stating that Egypt had other important and urgent issues that also needed support. I finally decided to provide a representative from the Government Accounting with an office in our headquarters to keep the finances accountable and transparent. This person would serve as an in-house auditor and would make sure that all Egyptian rules and regulations for the accounting procedures were followed.

GOAL and the ES prepared several proposals for the Inauguration of the Library, but it was GOAL in the end that prepared a final proposal for the Government's review shortly before the building was completed. This included lists of all the people who had worked on the Project, dignitaries and prominent personalities who had an interest, and possible activities for events ranging from one to three days to a week of celebrations. I had been presenting proposals to the International Friends for years to make them feel that this was their Library and that they should be part of the events. I had also proposed several ideas to UNESCO and other organizations for their participation. Some of these ideas were incorporated into the Inauguration in October 2002.

Many of the prominent supporters of the Library were invited to attend the "soft opening" in October 2001, including Dr. Romerio and other international figures. Those who could not attend that event were invited to the Inauguration in April 2002. Regretfully, due to political problems outside Egypt, the event was postponed until 16 October 2002. However, the International Friends held their 4th meeting in April 2002 and subsequently their 5th meeting in October 2002 at the time of the official Inauguration.



Mohsen Zahran with Serageldin



Mrs Mubarak with Serageldin and Zahran



“ The wiseman looks into space and does not regard the small as too little, nor the great as too big, for he knows there is no limit to dimensions.”

Lao-Tse

CHAPTER 7

ARCHITECTURAL, CONCEPTION
AND REALIZATION



Interior of Library, Cascades

The partnership of UNESCO made possible the financial support of Norway to the Project. This enabled the young architects of Snøhetta to cooperate with international engineering firms like Nor-Consult and others to prepare the Preliminary Design Review (PDR), and demonstrate the design concept and professional reliability of the team in various engineering and execution aspects. The PDR was submitted to the owner (represented by GOAL) for review and was discussed in the Expert's Meeting at the Palestine Hotel later on 3 May 1993, which concluded very positively with certain recommendations to Snøhetta to observe and adopt in preparation for the execution phases. This convinced the authorities to start the design and supervision contracts with Snøhetta and its Egyptian counterpart, chosen by them later on as Hamza Associates.

National Goals and Global Intentions

At the famous Aswan Meeting of the International Commission, President Hosni Mubarak declared clearly national intentions to build the Bibliotheca Alexandrina, as heralded in the Aswan Declaration of 12 February 1990. The President reasserted before the meeting and the world that Egypt was actively endeavoring to revive one of the most important monuments and greatest symbols of its civilization, the Library of Alexandria. He hoped that it would contain a comprehensive range of documents, encyclopedias and publications, both ancient and modern, related to Egypt, the Mediterranean basin, Africa and the Middle East and that special attention would be given to Alexandria as a point of encounter for all those regions and a venerable cultural capital where the cultures of the ancient Egyptians, Greeks, Romans and Arabs intermingled. He emphasized that the Library would provide research and academic facilities – through the most up-to-date methods and equipment – to researchers and students from all over the world.

Elements and Sparks of the Conceptual Ideas

1. **The Water:** The expanse of the harbor and the Mediterranean unfolds open vistas, horizons and infinite borders.
2. **The Circle:** The 160 meter diameter circle of the plan evokes a circular form which has been sheared about its western chord. The circle is reminiscent of astronomical bodies, the sun, the moon, orbits, vault of heaven, human brain, electronic chip, dynamism, motion, roundness, completeness, oneness, unity, integrity, order, discipline, reference, eternity, continuity, mobility, union, knowledge, modularity, multiplicity, circulation, and intangibles.
3. **The Roof:** From under the circular, tilted roof rises a disc inclined toward the sea. The roof is the elevation, the face of the rising sun, the window to the world, the eyes looking out, the beams of light pouring in, the cascade of light from the outside, conceived to reflect and affect the cascade of levels in the inside. The umbrella, the futuristic electronic microchip, ushers in cyberspace and the future technetronic age.
4. **The Tilting:** The internal section of the Library portrays the ground plane rotating about a datum nearly 16 degrees.
5. **The Stepping:** The Library great reading hall reveals itself as a cascade of terraced spaces that the roof echoes, unites and inspires.

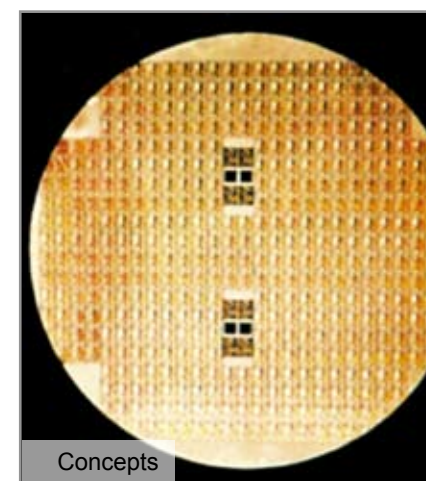
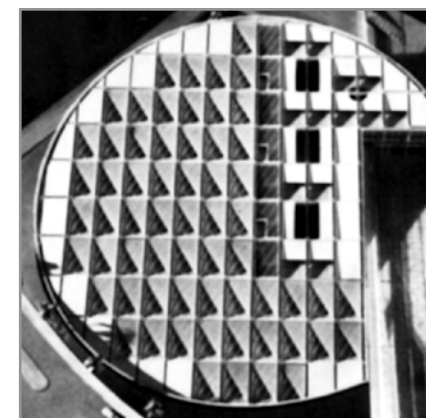

Concepts

6. **The Bridge:** It pierces the cylindrical mass, an arrow and a wing to connect divided space.
7. **The Wall:** Above the ground rises a cliff, composed of enigmatic scripture, letters of world languages and characters symbolizing global cultures, knowledge and civilizations.
8. **The Spine:** A chord with layers of connecting areas and dividing walls. Ancient Egyptian architecture excelled in using layers, so have the succeeding civilizations in both a physical and metaphysical sense.
9. **The Sphere:** Atlas, as seen in astronomical windows and vision, lies buried in the infinite horizons around and beyond.

Symbolic and Meaningful Associations in the New Library of Alexandria

The most prominent characteristic of the building is its circular shape. Content in itself and exceeding itself equally, it does not act as part of the homogenous skyline along the Corniche; which accentuates the prominent object. As seen from above it proposes the image of the sun. (Egyptian hieroglyphs show the sun generally as a simple disk).

The vital aspect of this space concept consists of shifting the building on ground level by tilting it into the ground. Therefore, it incorporates a reflection of the forces below the surface in mirroring them above the ground.

Cutting through the surface thus coincides with cutting through time. This assumes that time is defined by the rotation of the earth in its interplay with the sun, which is described by the horizon interacting with light, while the surface of the actual ground one walks upon represents the present. Thus, the turning point at ground level marks the point at which present meets past and future.

The tilting motion of the building is elucidated through the curving exterior wall which moves and repeats itself in reverse by rotating inside out when leaving the ground at the turning point datum. A positive-negative image is thus established which intensifies the initial impulse. This image is resumed once more in the wall texture as the plane is tilted out of the present creating inclined layers of time modeled on patterns emerging from nature. Here the layering is filled with scriptures carved in stone. The wall, responding also to light and shade, becomes a positive-negative image itself.

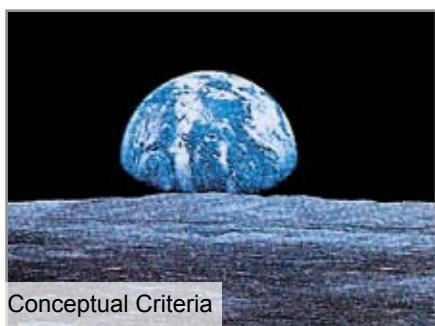

Conceptual Criteria

In surrounding the building with water, the ground plane corresponds to the sky by reflection. The reflected image of sun and wall is that of a fusion of sun, water and earth as essential forces of nature becoming static with the constructions of mankind.

A surface composed of rectangles completes the building upwardly. Due to this composition, the emerging grid creates a complex screen covering the interior space. This solution transforms traditional elevation aspects, making the roof screen the primary elevation of the building. The arising pattern is produced by solar sails installed at the ceiling, and thus allows sunlight to diffuse into the interior space. The construction resembles a skin which resolves various acoustic, light and temperature concerns.

Furthermore, the roof operates as a connecting link allowing visual access to the exterior and vice versa. Although this “coat” manner of presentation evokes a simple visual pattern, its structural process develops in three overlapping layers. The organization indicates the building’s interior and exterior structural processes, the conceptual positive-negative movement in organizing the sun shade conditions of the screen itself and the representation of the complexity of information contained in the Library. The roof may be seen as “microchip” which dictates the various conditions of interior and exterior activities.

As a general principle, motion is carried out in infinite, three-dimensional “space”. On the contrary, “time” is one-dimensional. “Space” shows the extension of things, their co-existence, their posture toward each other and their distance from each other. Motion in “time” is not reversible; all events proceed in one direction: past to present to future.

Therefore, providing a space for the New Library of Alexandria automatically rests upon innumerable symbolic and meaningful associations, physical and metaphysical, tangible and intangible. Those associations might originate in the prehistory of the Bibliotheca Alexandrina itself, or the universal fascination Egypt’s cultural history contains. They could be embedded in those experiences and achievements of mankind on how the outgoing 20th century represents them, and/or perceptions of any kind connected with moving toward a new time sequence during the turning of the millennium. Also, associations could be grounded upon what a library *per se* provides, serves and represents. Whether associations are based upon individual experiences, cultural mentalities and backgrounds, intentions or locations, the space shall inspire, allow, receive, reflect, uplift, honor, absorb, forward and direct them constructively and so become a vital binding element in space and time, as well as uniting and inviting people, races, places, and thoughts.



Conceptual Criteria

The Library will transform and present itself flexible through varying demands. Time can merge with this spirit, creating a space for human creativity. The Library can call for and inspire any type of associations and interpretations becoming a place of contemplation and dispute in every imaginable respect.

Experiencing the Progression of Functional and Spatial Accommodations

Upon visiting the Bibliotheca Alexandrina one can either cross a slender bridge which raps down into the plaza or pass through one of the courts on either side of the building. Additionally, a single bridge connects the University and the Corniche directly into the Library during working hours. On the plaza, a large sphere hovers within the ground. It houses the History of Science Museum and the Planetarium. The drama of the object is matched only by the contents within. Along the route, one would receive glimpses of the textured exterior wall of the Library. This texture is composed of scriptures and symbols throughout the ages and instills within our mind the pursuit we are about to encounter.

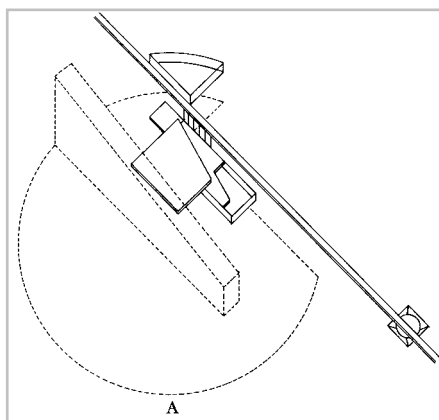

After crossing the broad entry doors of the Library, one enters a spacious glass-lined hall. Its name is derived from the ancient Ptolemaic dynasty, hence the Ptolemy Hall. This hall extends over three different levels and within this enclosure are exhibition and performance spaces, a bookshop and a Children's Library acting as a window onto the plaza. Also, a two-storey cafeteria is located adjacent to the Ptolemy Hall. Situated on the second floor, its broad balcony provides a panoramic view of both the plaza and the open horizon of the esplanade of the sea and the Eastern Harbor. All of these functions together comprise the Cultural Activities Department shown as Group "A".

Upon leaving these spaces, the path narrows and one passes through a small checkpoint into the Callimachus Triangle. This area, whose namesake is the great poet and Librarian Callimachus, becomes a gathering place for the users of the Library. Enriched with detail and graceful stairs as vanguards, it leads to the heart of the building. The visitors pass through a massive wall and enter onto an internal balcony. From this balcony one would enjoy the first view of the Library's dynamic and inspiring space.

Here stands proudly a vast panorama of light and texture. All around are slender 16 meter round columns beneath a sheet of diffused light. The vast curving wall of the Library's exterior is shown once again, this time as an enclosure. The floor of a space 160 meters wide and 80 meters deep terraces along seven primary and fourteen secondary levels which creates a flowing space with books cascading around and above, making the Library truly unique. The book stacks may extend behind each terrace providing

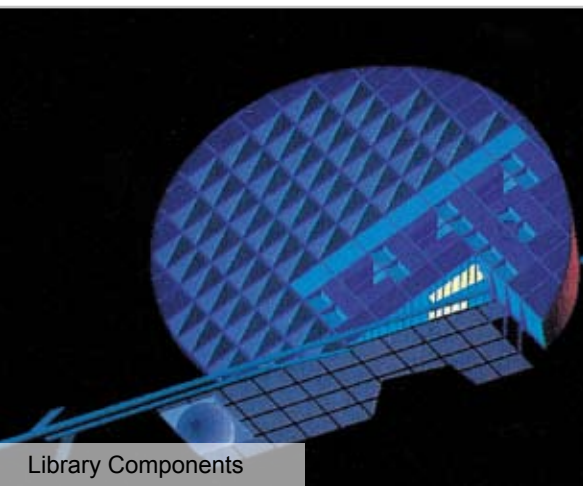

superior flexibility for the organization of each department. Accessing each of these levels is an external corridor or spine which allows independent entry to the terraces.

The views within the space are not obscured by the height of the book stacks themselves. Each terrace has viewing platforms to allow unobstructed visibility. We stand within a space which refers to the great halls within the libraries of the past, while maintaining modern flexibility and expansion considerations. Each terrace is lined with study cubicles giving the privacy of research cells contrasting with the openness of the public reading halls. These facilities composed of the books and periodical functions are labeled “B”.

As one moves deeper into the Library, to the three lowest terraces within the Hall, one finds more delicate manuscripts. Housed within a specialized and secure area, these spaces receive natural, diffused light from above, while the atmosphere here is more carefully controlled. Here also, in a more secluded area, music, audiovisual and electronic media departments are found and are acoustically separated from the main space. Yet from here one can turn back and see in entirety the Hall stepping upward toward its apex at a link with the curving wall and the roof. These areas have been shown as Group “C”.

While users are embraced within the main Library space, the directors, administration and personnel undertake the many tasks which keep the Institution alive. Much of the administration is housed adjacent to the main space and is organized along a series of spacious light courts. Their hierarchy is reflected within the building section having directors on the upper level, each with a private terrace facing the sea. This division has been labeled “D”.

The life of a book within the Library begins in the cataloguing rooms. These areas have been placed around one of the light courts to allow ample light and comfort to the persons handling the thousands of items passing through the building each day. A mechanized book transportation system is used to move the books from these areas to the many levels of administration for wider distribution. This division has been labeled “E”. The books often require repair and inspection. Books may be moved manually from the checkpoints and administration to the workshops within the building. Books are primarily moved along the central continuous corridor adjacent to the main space. These tasks require good lighting conditions; therefore they have also been located around a light court. These functions have been shown as Group “F”.

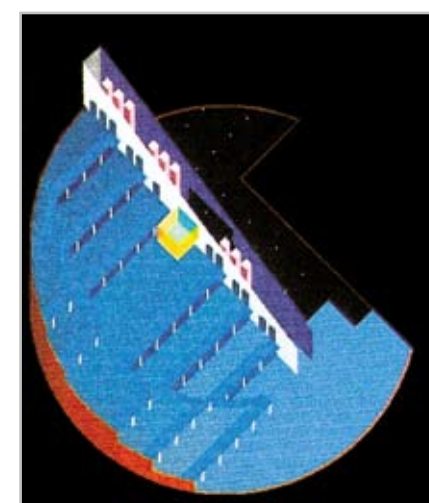
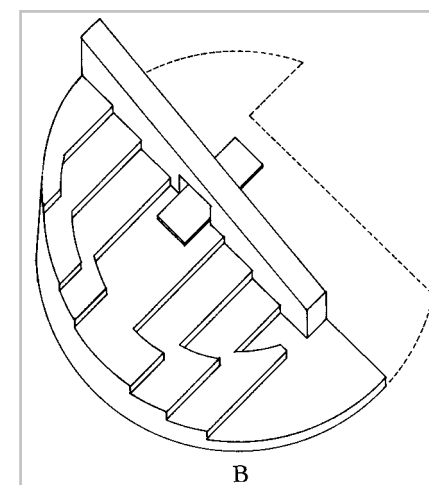

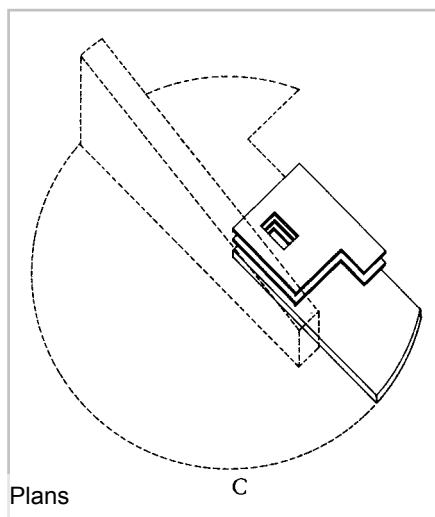
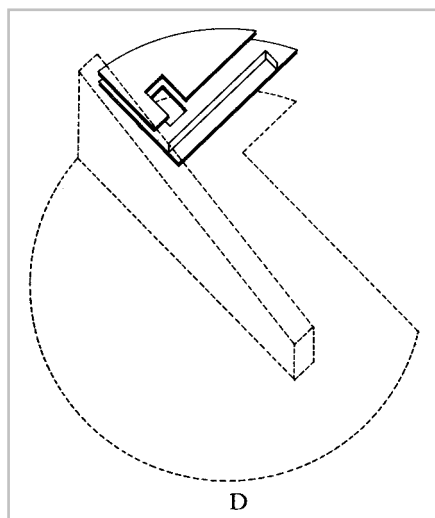
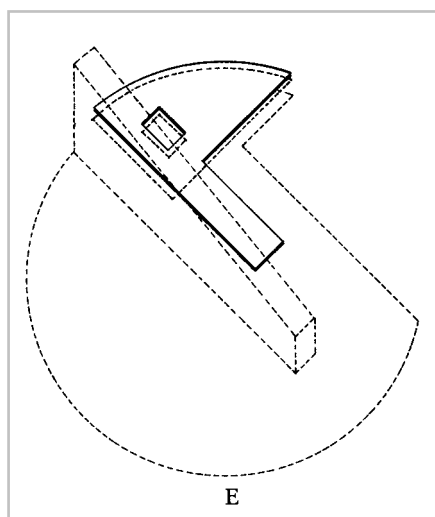

One aspect of the New Bibliotheca Alexandrina which extends its use beyond the ordinary services of a library is the school it houses within its walls. ISIS or the International School of Information Sciences will train scholars in the art and science of information studies. It is located in a triangular protrusion from the main building and is placed to be accessed directly from the bridge linking the University to the Library. This allows for a degree of independence both in appearance and in function. Nevertheless, during regular working hours ISIS may be accessed from the Ptolemy Hall. The school is pierced by three light courts and many of its offices command the brilliant view of the sea. It works together with the Library as an expression of the future livelihood of the Institution. This school belongs to Group “G”.

Finally, an integral component of the Library complex, which extends its function beyond its traditional use, is its relationship to the neighboring Conference Center. The two institutions, although independent, share some facilities. The New Library provides new offices, meeting and storage space below ground level and adjacent to the Conference Center. These functions have been noted as “H” functions. Light will be provided to these rooms through a glass wall which overlooks the Library roof. This link will help maintain the philosophic integrity of the two ideas: debate and research.

Architectural World Wonder and Engineering Marvel

The US magazine, the *Conde Nast Traveler*, describe the Bibliotheca Alexandrina as one of the seven world wonders of new architecture. The universal message in the wall, and the Egyptian engraving and sun symbol pay homage to history. Thus, the external wall is typically ancient Egyptian with wall relief as in the pylons of temples. The wall is a cliff-face of roughly hewn grey granite panels 200 x 100 x 15 cm and 100 x 100 x 15 cm, from a special quarry south of Aswan, carved, as in ancient Egypt, with letters from world alphabets, characters and symbols.

The most impressive element in the building complex is the huge hall directly below the tilted disk. Here, all the Library’s reading rooms have been combined into one immense open-plan space stretching through the entire expanse of the roof overhead. As big as New York’s Grand Central Station, it is by far the largest library reading room in the world. The reading areas for the Library’s different departments are divided into seven terraces that cascade downwards below the sloping roof. Through these reading terraces rises a forest of cylindrical concrete columns, and daylight filters in through skylights that run diagonally between the columns.

There is no escaping the captivating and exhilarating space and spirit of this building, inside or out. However, the real richness and resonance of the architecture comes from the counterpoint between bold sculptural geometric forms and mechanical modular repetition, and no less from the counterpoint between state-of-the-art functionality and timeless symbolism.

As Christoph Kapeller, Snøhetta's Austrian founding partner and project architect explains: "We worked from the book outwards." The geometry of the building is primarily generated by the functional arrangement of bookshelves and reading desks into identical structural bays measuring 14.4 x 9.6 m. The 16.08 slope of the roof enables these bays to rise by a series of 4.15 m high storeys.

This strictly functional grid is contained within a building perimeter in the symbolic shape of a circle. "The circle expresses the containment of all human knowledge," says Kapeller. In fact, the Library is 11 storeys high, contained in a cylindrical envelope with an ovular cross-section. However, because the cylinder is tilted at an angle of 8.04 to the vertical, the floor plate and the roof form true circles for the horizontal floor plate and the roof plane. Like the British Library, completed in 1997, the bulk of the building is placed underground to protect its precious paper freight from the external environment.

The Library's great reading hall, accommodating 2500 seats, coalesces into an open plan, punctuated by columns. Some described it as a sanctuary, a holy space, an inspiring, exhilarating and challenging space. First, there is the drama of seven terraces that cascade down through the space. Then, there are the 56 repetitive skylights that cover each structural bay. The skylights have been precisely orientated at the diagonal to face north and exclude direct sunlight – the enemy of books – while admitting glimpses of the blue Mediterranean.

Each skylight bisects its sloping roof bays diagonally between columns, and the lower lip of the roof has been gently folded downwards. To support these roof bays, the slender cylindrical concrete columns expand into elegant elongated conical capitals. Although simple in concept and identical in design, this repetitive grid of roof bays and columns builds up an extraordinary sculptural rhythm over the entire sloping roof plane, with each bay being slightly modulated in form by the varying vertical and horizontal angle of vision.

The combined effect is not so much that of a western cathedral's linear nave and aisles, as of a gigantic mosque, such as the Mezquita in Cordoba, with a grid of columns stretching as if to infinity in

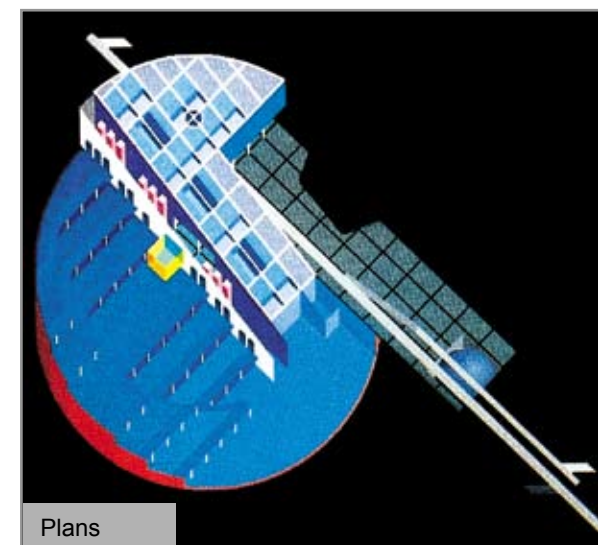
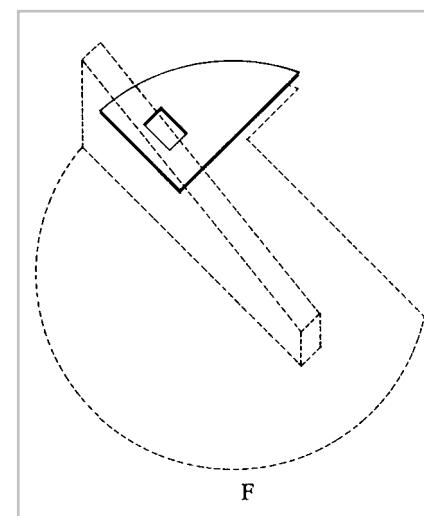

every direction. Kapeller also acknowledges that the conical capitals bear a fortuitous resemblance to the carved marble capitals of Byzantium. The reading hall also calls to mind the hall of columns of the ancient Egyptian temple complex at Karnak.

The public plaza on the 45,000 m² site is called the Plaza of Civilizations, the first such open air plaza in Egypt and the region. It unites and organizes activities and pedestrian circulation in between the existing Conference Center, which was donated along with the site by Egypt to the Project, the main Library, and the Planetarium. The Plaza opens up to the vast horizons of the stunning Eastern Port. Separated from the coast by the Corniche Avenue, the Plaza rises a few steps above the street level, with a nearly 150 meter long flight of stairs inviting people to step up, and measure up, with open arms.

Validity of Architectural and Engineering Genius

Wonderful architecture alone though, provides no protection. Waves of the Mediterranean splash on the shore only 40 meters away and the salt water will attack the Library. A life expectancy of some 200 years has been estimated. This close vicinity to the sea with an unstable subsoil and water pressure and a combination of resulting upward forces with extremely asymmetrical loading called for a special foundation, particularly as the loading eccentricity can be accentuated by the wind and in the worst case, seismic activity.

Tensile and compressive forces are transferred to more than six-hundred piles. At the north end, where the load from the building is smaller and thus the water pressure higher, the piles have to take up tensile forces and at the south end, compressive forces. The crucial question is how can piles withstand tensile loading. At a depth of about 24 meters, they come into contact with sandstone and extend into it to a depth of 39 meters. In this layer of sandstone, the cast-in-place steel reinforced concrete piles open out to a bell shape. If they have to take up tensile forces, they have a double bell shape, this being a world premier in construction. The equipment whose rotating cutters mill away the sandstone with a bell shape – like an undercut anchor – is said to be the first that can cut downwards and sideways with a hydraulic drive.

The 20-ton double concrete roof beams were pre-cast on the site and lifted up by a complex system of cranes working in tandem. They give the general roof grid of the microchip measuring 14.40 x 960m and shaping at an angle of 16.08. Thus the slope of the roof enables the cascading levels to rise by a series of 4.15 m high storeys.

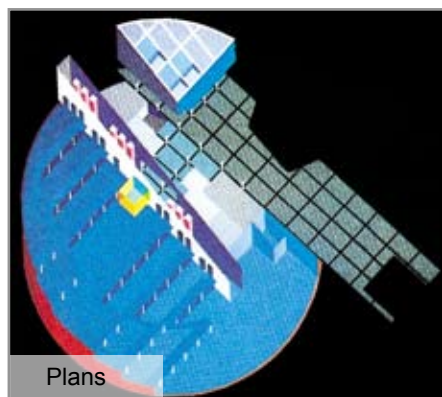
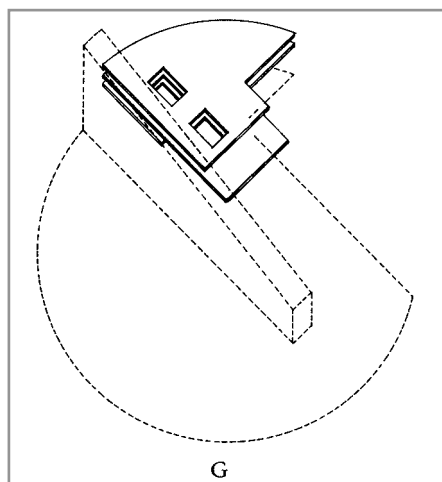
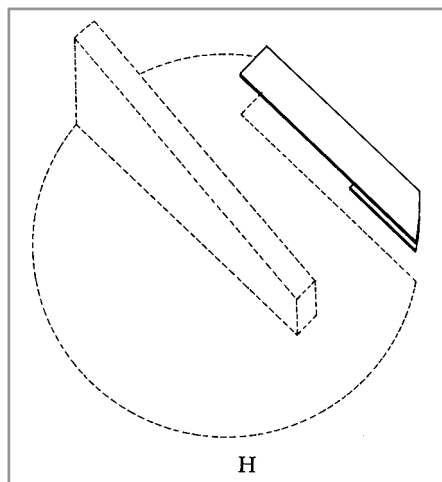

The Planetarium sphere is clad with glass fiber reinforced cement dark grey panels with white stripes that hide blue light which evokes a feeling of flotation, orbit, and outer space around the moon.

At night, blue stripes light up around the spherical Planetarium that symbolizes the moon. It is faced with charcoal grey glass, reinforced with concrete, which set off the flat animated circular Library roof and contains a 100-seat theater. During the day, it provides a large, dark fixed point on the grounds of the Bibliotheca Alexandrina. To achieve this, a steel structure was clad with very thick glass. A cross and a ring made of steel were fastened to the concrete with adhesive anchors. Assembled steel structural components, in turn, were mounted in advance on the cross and ring.

Unique Formal Spatial, Structural and Functional Realization

This building's diameter of 160 meters probably makes it the largest cylinder in the world. Four of its eleven floors are underground. The ground floor is eleven meters below groundwater level and 10.2 meters below sea level. A so-called diaphragm wall, extending 35 meters into the ground, prevents water infiltration from the side. On top of the cylinder, its glass "lid" has an inclination of nearly 16 degrees towards the north. As a result, floor space decreases from the bottom to the top storey, but the load from the building increases towards the south.

Approach the building from the Corniche Avenue along Alexandria's seafront and you find spread in front of you the huge, silvery, tilted disc of the lid to the elliptical cylinder. The disc rises at its low angle from below pavement level and is nearly surrounded by a pool of water. The disk is faced in silvery, smooth aluminum sheeting, and this top surface has been scalloped to create the identical diagonal skylights lighting the reading hall below. The aluminum clad indents are softly molded like airfoils, and the diagonal skylights are shaded by curved glass eyebrows.

Kapeller takes delight in describing the low, sloping disc as a "non-building", creating a gap, a breathing space, in the 13-storey wall of buildings that make up Alexandria's seafront. He explains that the silvery disc mirrors the glorious crescent-shaped sweep of water in the city's natural harbor. It reflects the natural discs of the moon and sun rising slowly above the horizon – two of the oldest icons in Egyptian mythology. The roof, with the repetitive aerofoil shapes of the indented skylights, is also unmistakably high-tech, for which Snøhetta found inspiration in that archetypal industrial component of the new millennium – a microchip wafer.



Views of the Planetarium

Approach the building and you are faced with another monochrome expanse, this time of the cylinder's perimeter wall as it rises above pavement level. Far from being a smooth, metallic high-tech skin, this is a curving cliff face of roughly cleft grey granite, quarried in Aswan. The only modulations in the granite cliff face are large letters that have been carved into its surface. The letters have been borrowed from as many alphabets as could be found—an obvious reference to world literature.

Four other bold elements make up the external form of the complex. A large sphere faced in charcoal grey glass-reinforced concrete sets off the flat disc of the Library roof and contains a 100 seat planetarium. An open plaza has been formed between the New Library and an eight-year old concrete Conference Center, which has now been incorporated into the New Library complex. The side of the cylinder fronting the plaza has been cut off flat and faced in curtain walling to create the main entrance and restaurant for the complex. A steel walkway picks its way at high level through the site from the seafront to the existing university behind the complex.







The New Library of Alexandria is hailed by the international architectural community as a “contemporary classic”. Whether its historic references will be enough to charm Egyptian visitors is another matter. Recognizing that Egyptians have a weakness for colorful baroque styling, Kapeller has added small panes of colored glass into the monochrome roof to add splashes of blues and greens to the interior.









Interior of Library



Library Roof under Construction

Point of comparison	Architect	History	Main Concept	Philosophy	Point of Strength Or Weakness
British Library	Colin St John Wilson and partners.	Inside, the great blue dome of its Library's Round Reading Hall, where for generations innumerable writers studied, has long been part of the sacred imagery of scholarship.	Followed the same British way of building to make it comfortable for the visitors.	Informality of building to make the visitors feel the importance of the function of building. 	The inside and the outside cannot relate together, the architect designed the building from the inside out, a large building trying to look small. The brick tower with clock is not big enough to make a vertical axis. 
French National Library	Dominique Perrault.	First it traces its origin to the royal library and then moved to newly constructed buildings.	Four L-shaped glass towers surrounding a rectangular podium with a hole.	Monumentality and presidential ambition. The inaccessible grand towers glorify books, yet reading areas are enclosed and trapped in massive towers. 	It is not sensible to store books in glass towers and then shield them with modern screens 
Library of Alexandria	Snohetta (International Practice).	It is built on the same site of the Ancient Library of Alexandria.	The sun rising from the Mediterranean as if it were the rise of a culture to eternalize the old culture of Alexandria.	It is a monumental building with great symbolism and meanings. The building's light roof allows it to open toward the Mediterranean to reflect the water of the sea on the building and make an extension of it, as if it were rising from the sea. 	The main entrance is very weak because it is not large enough for the great number of visitors. Its location does not fit with its importance. Books are stored on all levels at the back, shielded away from light, heat and humidity. 

Exterior Form	Interior Design	Building Effects on Visitors
<p>This view of the rear of the building shows the screened terrace with the restaurant which is easily accessible from all the public areas and provides a dramatic view of the library.</p> <p>The building is formal and strict because its type follows the traditional English architectural character, which can be seen in all private houses in London.</p> 	<p>The furniture and light fittings in the humanities reading rooms were designed by the architect whose aim was to create the solid, unobtrusive, durable comfort and utility. The reading area for the Oriental & India Office Collections is a double height space allowing paintings from the collections to be displayed on the wall space above the 78 reader desks.</p> 	<p>The Library is set back from Euston Road to allow for the creation of an enclosed courtyard to mediate between the turmoil of traffic on the main road and the point of entry to the building.</p> <p>The Piazza provides an open space for readers and visitors to relax. There is an amphitheatre for small-scale open-air performance</p> 
<p>The architect used the wooden shutters and solar glass to protect books within towers.</p> <p>The glass towers make regular readers troop up the steps to the podium from the street and then make them descend into its bowels.</p> <p>Its external form shields a rich and surprising interior.</p> 	<p>The wooden floors and rust colored carpets separated by huge sheets of semi-opaque screens between the stacks and reading rooms.</p> <p>Fine metal webs across the windows soften the light and reflect upon the walls.</p> 	<p>There are oppositions between the forbidding gray exterior and the engaging interior rich in color, the busy life of the city outside, and introverted cloister inside is intriguing.</p> <p>Interior design of the Reading Hall follows function and makes the library comfortable for visitors.</p> 
<p>It is a huge disc of glass and aluminum which is tilted northwards towards the Mediterranean.</p> <p>The disc is supported from the south with a massive battered wall, it is clad with granite slabs with inscriptions engraved in all the writings of humanity. This reminds of the building function, the lost Ancient Library, and the Egyptian civilization.</p> <p>The architect used a bridge to make a link between the Library and the Mediterranean culture.</p> 	<p>The interior is formed of one great space with cascading levels where the different subjects are located.</p> <p>The use of terraces inside the building helps the view of the great space not to be obstructed by bookshelves.</p> 	<p>The building is surrounded by a reflecting pool and large public plaza, connecting it to the city as a gathering place for contemplation and debate.</p> <p>Interior design follows function and makes the Library comfortable, engaging and inspiring for visitors.</p> 



“ Give to the world the best you have and the best will come back to you.”

Madeline Bridges

CHAPTER 8

CHAPTER 8

THE IMPLEMENTATION
PROCESS



Floating Clouds Hovering above the Cascading Levels

It was a matter of utmost necessity to call upon international expertise throughout the implementation process and execution operations. First of all, this was a prestigious international project with a unique focus that galvanized the international community towards a common goal. Secondly, there were important principal aspects that had to be considered such as:

1. The new building with its complex components and systems embodies a state-of-the-art, unique concept.
2. The design has been the first prize-winner of the international architectural competition that attracted world attention and acclaim.
3. The Project was given national prominence and was placed under the auspices of the President.
4. The ancient Library of Alexandria had a great impact on world knowledge and civilization, and thus the Revival Project attracted the moral and tangible support of international organizations

and countries worldwide. The Project was under the scrutiny and watchful eyes of international and national circles and bodies.

5. The building's unique architectural and engineering characteristics required the adoption of the latest international building technology capabilities.
6. The New Bibliotheca Alexandrina was to be inaugurated at the beginning of the third millennium. It was required to be a digital library and a principal interactive information technology resource that would interface with the cyberspace and the technotronic age. The information and communication technology capabilities should be manifested and fully operational to serve as a model for others in the region to follow and to accommodate research and user needs of the 21st century.

Preliminary Design Review (PDR)

After the announcement of the Competition results on 25 September 1989, Egypt wasted no time. A mission to Oslo by Moufid Shehab, Advisor to the Minister on the Library Project resulted in a US\$ 500,000 contribution by Norway for design development paid as a “funds-in-trust” (FIT) with UNESCO. Snøhetta contracted structural consultants, mechanical electrical consultants to prepare the Preliminary Design Review, which proved the buildability of the concept. I met with Snøhetta several times to assess the progress and offer my professional views.

Contract for the Design

The negotiations for the design contract began immediately after the award of the first prize to Snøhetta a.s. During the jury process and in the subsequent seminar at the Palestine Hotel on 3 May 1990, several criticisms were leveled at their design which they agreed to take into consideration. They responded to this with sensitivity and creativity when they met with the technical committee that revised the design requirements with them. They were soon faced with the normal bureaucratic delays that are always part of any large civic project, while officials reviewed how financing could be achieved, and while each side negotiated for its own benefit. Eventually, the Consultant's contract was signed with the Snøhetta/Hamza Consortium on 23 October 1993 in Cairo at the Ministry of Education. This delay in signing the contract was one of the major reasons for the increased cost of the building (due to inflation, and other unexpected design requirements).



Construction Monitoring

Archeological Investigations and Studies at the Library Site

The delay in the contract negotiations provided time for other necessary preparations to take place before construction could begin. One of the most vital work and investigation urgently needed concerned the antiquities that might be uncovered during the foundation excavations. Another was the preparation of technical studies and reports on the site soil and ground engineering characteristics which included the land survey, soil tests and analysis, and other information necessary for the preparation of the foundation design. These studies and reports were the responsibility of the Owner to undertake and furnish the pertinent reports to the Consultants.

The site allocated for the Revival of the Bibliotheca Alexandrina was reported by historians and archeologists to have been part of the Royal Quarter, according to the ancient plan of Alexandria, on which the Ancient Library was built. This fact gave the Project a special historical dimension; the New Bibliotheca Alexandrina would be rebuilt in the vicinity of the original site. It was by the grace of God that the site had remained vacant for years reserved for this historic undertaking, after being used as a camp ground by various armies in Alexandria's recent history.

It was of paramount importance and an obligation for GOAL to contact the Egyptian Antiquities Organization (EAO) in 1991, after the international commitment (during the Aswan Meeting), requesting them to undertake the necessary steps and actions to carry out archeological investigations at the site. The Antiquity Authorities, who are solely responsible by law for all Egyptian antiquities and archaeological investigations, responded positively and requested GOAL's cooperation to allocate the necessary financial resources and technical support. The requested funds were immediately transferred to the Antiquities Organization account to begin their investigative work.

In the meantime, the Vibro Foundation Company (public sector), specialized in soil investigations, foundations, and ground engineering works, was contracted to work at the site in cooperation with the EAO staff and consultants, to remove the top soil, so that the Antiquities investigators begin their technical work at the site in May 1993. The archeological excavation and investigations continued for two years, during which several visits to the site were made by the Director General of EAO and by their consulting archeologists from Poland. The entire work was supervised by Doria Said and Ahmed Abdel Fattah, Directors of the Alexandria Archaeological and Western Delta Sectors.



The Antiquities investigators carefully removed soil, debris and rocks to the level of the water, about 14 m below ground level. This was the level of land at the time of the Ptolemies. It was at this level that the artifacts were discovered, mapped, documented, and removed. The archeological works at the site yielded two beautiful mosaics, dating back to the Ptolemaic period, various marble pieces like heads, arms and sculptural pieces, and pottery dating back to the Ptolemaic, Roman and Islamic periods. The smaller artifacts were removed without difficulty; however the two mosaics broke apart during the process. These have been restored and are now displayed in the Antiquities Museum at the Library. Photographs of the mosaics prior to their move show the beauty of the designs and the technically superior workmanship. In addition, one water cistern was uncovered, and underground shelters built by the British Army during WWII. However, nothing was found at the site concerning the Ancient Library.

All the archeological finds were removed from the site to the Greco-Roman Museum in Alexandria for restoration, and storage. The Ministry of Culture agreed that all archeological discoveries at the Library site would be exhibited under their technical supervision, at the special Antiquities Museum to be established in the New Library building, thus linking the New Library to its original historic era.

These investigations took about two years and they were not without criticism. This was one of the few sites in Alexandria that was still “unbuilt” and many archaeologists, officials, citizens and other interested persons suspected that there were rich historical treasures to be found there. Those concerned with the preservation of antiquities and their locations, though technically unqualified, did all that they could to harass and question the Egyptian Antiquities Organization (EAO) investigation, and criticize the work during the process. In fact, the police were called in on one occasion indicating the degree of unjustified tension and intervention. This was reported in the international news and gave an unfounded negative impression of the Project to the international community. It was not until after the Inauguration of the Library in 2002 when visitors and Egyptians alike could view the uncovered artifacts in the new Antiquities Museum that they began to understand the truth, honesty and transparency of the great efforts that the Egyptian and foreign archaeologists had made during this investigation period.



Archaeological Find



Mosaic

The Site Characteristics and Studies

To begin the design and execution activities, it was the responsibility of the owner to furnish the Consultants (designer architects and associated engineers) with accurate and detailed information and technical data concerning the following:

1. Accurate survey maps of the site and its surrounding vicinity within 500 meters in all directions. The Alexandria Survey Directorate undertook the preparation of all the required site surveys and submitted their maps on time for use by the Consultant;
2. Accurate and detailed studies and investigations of the soil characteristics and all data concerning test borings, the soil geotechnical engineering properties, and the necessary technical report concerning groundwater table, soil bearing capacity for the foundations design;
3. In addition, a university professor of survey was hired to check the survey and prepare digital maps for the Consultant.

The Site Geological Profile

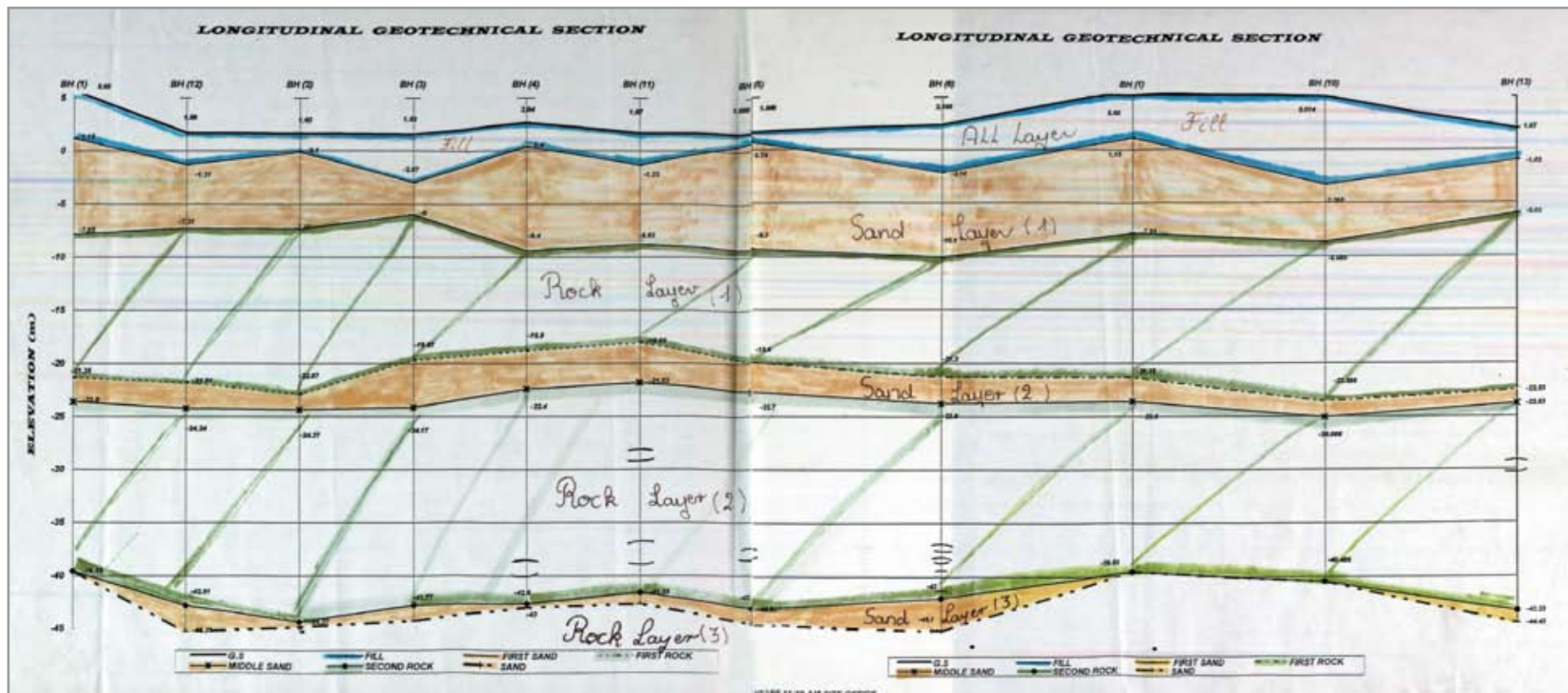

The Ministry of Education, upon the recommendation of GOAL, hired the Arab Bureau for Consultations and Designs (Government Design Office) in 1993 as a consultant to carry out the soil investigation work, and to supervise the investigation work performed by the Contractor; Vibro Foundation Company (a public sector foundation construction company). Dr. Mamdouh Hamza, foundations expert and consultant, was also hired by the Arab Bureau as a sub-consultant to oversee the site tests and the preparation of the final ground engineering report. Later on, Dr. Hamza formed the consortium with Snøhetta. Nearly 100 test borings were made throughout the site with depths ranging from 50 to 100 meters. This report on soil investigation was submitted on time in 1994, and was also conveyed to the consortium for their information during their design process.

The Project's famous bridge was to link the University campus across Port Said Street to facilitate easy access for students. I finally received a letter from the University Secretary General reasserting the University's adamant refusal to allow the construction of the bridge column next to the outside wall and inside the campus. I contacted the Governor and finally managed to obtain his approval on the termination of the bridge and the stairway at the sidewalk outside the campus.

Investigation of Seismic Characteristics

Alexandria is located in the third zone of earthquakes in the Mediterranean region, and is often subjected to quakes and tremors. This made it necessary to secure all pertinent data on the site for the designers review. Historically, the Pharos lighthouse, one of the Seven Wonders of the Ancient World, is reported to have been destroyed by earthquakes several times, the last of which was during the 10th century CE which caused its complete and final destruction and collapse.

The sunken cities discovered in the year 2000, near Abou Kir, east of Alexandria, only proved that earthquakes and tidal waves were responsible for the destruction and disappearance of many Pharaonic, Greek and Roman monuments in the Alexandria region, perhaps including the Ancient Library.

It was therefore, of great importance that the Library authorities commission the National Institute for Earthquakes and Seismic Studies in 1992, in parallel with and during the period of contract negotiations with the Consultant, to undertake the necessary seismic investigations, and to prepare a pertinent scientific and technical report on the site to be taken into design consideration by the Project Consultant. It is interesting to note that Cairo and Alexandria suffered from a major earthquake on 16 October 1992, which caused the damage and destruction of a few buildings in Cairo and Alexandria.

It was brought to everyone's attention the necessity that building design and construction must take into consideration possible earthquake occurrences in this region. It was published in the media that the Alexandria Library Project was the only public building in Egypt that requested a seismic study report before execution. The technical report was submitted in 1993 and was conveyed to the consortium for use in the building design specifications, and execution specifications.

The Design Process

Once the contract for the design and engineering was signed, the Snøhetta/Hamza Consortium immediately began to work. The work was divided into phases to better suit the construction process. Each time a benchmark was completed a meeting was held in Alexandria with the architects, quantity surveyors, Executive Secretariat, the professional technical committee, and GOAL engineers who later joined the Construction Monitoring Unit. All the details of the design were discussed and critically evaluated to make sure they met Egyptian standards and requirements, as well as international standards. In all, there were nineteen such meetings for Phase I, and thirty-five meetings for Phases II and III. It was during these meetings that space allocations for various departments were revised, where qualities and sources of materials were discussed, and essential technical engineering issues for such an unusual building were established. We called on local and international advisors to help with the evaluation and design development until the final approval was issued.

The UNESCO feasibility studies provided a good basis for the services that would be needed in the Library so the owner did not feel the need to provide additional information on that level. There were a number of discussions about Egypt providing interior design services for the architects. The owner's point of view was that the designers should provide a total package for the Project. My colleagues and I felt that the architects had impeccable taste and could do the job very well and the building testifies to their outstanding capabilities. I should note that the architects did their own research to develop the concepts they used for floor plans, people movement, book movement, services, and the materials that they used throughout the building. I do not deny that my indirect professional suggestions or inspirations were occasionally conveyed to the architects.

Once the designs for the foundations were finalized and approved, the work to prepare the documents for the construction's tender actions began. The design process for the "superstructure" was a concurrent process with the Phase I Tendering Process and then execution of the construction.

The preparation of the working drawings was also a complicated and demanding process since precise details on all aspects of the design had to be provided for the contractors to estimate their needed equipment, supplies and labor.

Need for International Know-how and Technology

The owner, represented by the Ministry of Higher Education Consultative Committee, cooperated with the Project Executive Secretariat, and the Project Consultant to lay down essential criteria to be incorporated in the pre-qualification stage for each construction phase. The Project Manager, as Head of the ES, was named in the tender documents to represent the owner.

It was decided that the Project would be executed according to three Tender Packages (TP) due to the complexity of the building program:

1. TPI: This phase was estimated to last for 400 days.
2. TP2: This package of works included the execution of the structural mechanical and electrical system of the Super structure.
3. TP3: This package included all other systems, internal and external finishes, fit-out and landscaping of the site bordering areas in the surrounding avenues and streets.

It was later decided to incorporate TP3 with TP2 to become the Phase II execution phase to span 900 days. In addition, according to Egyptian law each international tenderer had to establish a joint venture with an Egyptian engineering firm, as it was also applied with Snøhetta, the first prize design winners.

This was a very high profile international Project so every effort was made to ensure complete fair play transparency, professionalism, credibility, and confidentiality for both national and international joint ventures of contracting companies tendering for the Project. It was decided that each tender action would be preceded by a pre-qualification stage open for all eligible contractors from Egypt and abroad.

The pre-qualification terms of reference books included the needs and important information for those who would evaluate their tender offers. These were summarized as follows:

- Relevant past construction experience
- Execution of projects of equal nature magnitude and value
- Documented financial strength during the past 5 years
- Financial line of credit by international bankers, equivalent to the Project cost
- Years of experience at home country and abroad
- Technical professional staff and human resources capabilities
- Indication of all technical staff to be assigned to the Project with relevant site experience
- Available technical resources and equipment both qualitatively and quantitatively
- Proof of distinguished professional performance
- Proof of credibility and accountability
- Legal disputes
- Past and concurrent strategy, plans and procedures for the Project execution
- Letters of recommendation from clients of executed buildings
- Building legal documents, attesting to the Tenderers Joint Venture agreement and that both are jointly and severally responsible for works executed
- Due registration according to Egyptian laws with the Syndicates, union and other public authorities
- Egyptian Laws would govern the contract
- Maximization of use of Egyptian materials, products and human resources, to ensure proper transfer of know-how and the latest technological developments
- Due respect of building laws, ordinances and local governments regulations, permit, and rules
- All customs dues, taxes, stamps were the sole responsibility of the contractors
- Commitment to facilitate easy operations and maintenance of all building systems, networks and finishes internally and externally.

Prequalification and Tender Action

Tender Package I (TP1) for the foundations and ground engineering works were to be executed by international/national joint venture contractors specialized in deep foundations because of the specific

nature of the soil and the location close to the Mediterranean Sea, especially since four basement levels in the design were 12 meters below ground level.

The owner, the Egyptian Government, was represented by the Minister of Higher Education, in his capacity as Minister and as Chairman of the International Executive Committee (IEC), which includes Egyptian and international members and UNESCO Representatives.

List of Contractors for the Prequalification for TP1:

- Archirodon Construction (Overseas) Co.S.A.
- The Arab Contractors
- The Arab Foundation Co. VIBRO
- Bauer Egypt S.A.E.
- BENOTO
- Bilfinger + Berger
c/o FRU-CON Construction Corp. Joint Venture
- Bouygues S.A.
- Condote-Mazzi Estero S.P.A. Rous
- Cooperativa Muratori & Cementisti
- Daelim Industrial Co.,Ltd.
- Doosan Construction & Engineering Co.Ltd.
- Dragados Egypt
- El Nasr General Contractor, Hassan Allam
- Garboli Rep. S.P.A.
- GEPCO-GENOVA
- Hochtief, Egypt Branch
- Imperegilo-COGEFAR
New Esna Barrag Joint Venture
- Kajima Corporation (Egypt)
- Maurizio Bigelli, S.R.L.
- Misr Concrete
- Misr Sons Development
Hassan Allam Sons S.A.E. Joint Venture



DMC and Follow-up Committees

- NCCD/NOCON
- Raymond-Rodio
- Sami Saad & Co.
- SAE International
- Selmer A.S. Civil Engineers & Contractors
- Sezai Turkes Feyzi Akkaya Construction Co. (S.T.F.A.)
- Sif Enterprise Bachy
- Societa Edilsonda Cost.
- Solestanche Entreprise
- STFA Temelpile Construction
- Todini Costruzioni Generali S.p.A.
- Trafalgar House Construction Special Projects, Ltd.
- Yuksel Insaat A.S.

The Project Manager, as Head of Executive Secretariat, the third party designated by the Agreement with UNESCO to carry out implementation tasks and responsibilities, was named in the tender documents to represent the owner, on behalf of the Minister. It was decided that each Phase would have its own prequalification invitation to be advertised nationally and internationally.

Phase I

Tenderers submitted their dossiers by March 1994 to the Executive Secretariat office in Alexandria. Twenty-one national and international contractors submitted their qualification dossiers and relevant documents.

The Minister created a Decision-Making Committee (DMC) chaired by Dr. Mohamed Fathalla El Khatib, which included professors, experts and officials in engineering, law, finance, management, accounting and administration, as well as the state council justices. This Committee worked in cooperation with the Executive Secretariat staff and experts. After extensive study by the Committee and the Consultant the ten most qualified joint venture tenderers who fulfilled the criteria and requirements of the pre-qualifications stage were selected. This was not an easy process since many countries wanted their engineering firms to participate in such a prestigious Project.

The chosen four contractors entered into a tender action in July 1994:

- Bauer/Bilfinger + Berger
- Kajima Corporation
- Rodio/Trevi/Arab Contractors
- Sif Bachy/Soletanche/Trafalgar House

The four tenderers submitted their final tender offers in October 1994. The same Decision Making Committee met in Alexandria several times and studied the tenders meticulously. They reached their recommendations in February 1995 to select the best tender, from both the technical and financial aspects. The winner was the joint venture of Rodio (Italian 65%), Trevi (Italian 17.5%) and the Arab Contractors (Egyptian 17.5%). The leader in the joint-venture was Rodio with extensive experience in deep foundations, in Asia, Africa, Europe and USA. The contract of \$54.5 million was awarded to RTA in a ceremony held on 22 April 1995 at the Ministry in Cairo.

RTA started their work at on the site on 15 May 1995. Shortly after the beginning of the work, Dr. Romerio retired, and I continued to carry out the full professional load. RTA completed their work on 31 December 1996, after extending their work to include the raft slab and waterproofing insulation, which were detached from TP2/3 and awarded to the TP1 contractor at the same approved rates.

Phase II

Phase II included both TP2 and TP3. This included the execution of the superstructure, services, finishes, landscaping, and other external work. The same procedures for Phase I were strictly followed in Phase II. The public announcement of the prequalification invitation was advertised in June 1995.

Submission of pre-qualification dossiers and supporting documents was in August 1995. Twenty-four joint venture contractors from the Middle East, Europe, USA with their Egyptian partners competed for this stage. At the ES, I prepared with my assistants the descriptive, evaluative, reflective, and comparative studies of the tenders for the Decision Making Committee.

List of Companies for Prequalification for TP2:

- Ansaldo
- Arabian Int. Consortium



- Archirodon Construction
- China Jiangsu Int., ME Branch
- Cooperativa Muratori & Cementisi
- Consolidated Contractors Int. Co. (SAL)
- Daelim Industrial Co.
- Doosan Construction & Eng., Cairo
- Dragados Construction Egypt
- EGYCO
- El Nasr General Contracting
- EMAK Contracting Co.
- GTM Entrepouse, Cairo
- Hochtief, Egypt
- Joannou & Paraskevaides
- Joint-Venture: Arab Contractors/Balfour Beatty Int.
- Joint-Venture: Campeon Bernard, SGE/Societe Auxillaire/Spie Batignolles Egypt
- Kajima Corporation, Egypt
- Migecon for contracting & Development, Cairo
- Misr Concrete
- Recchi S.p.A. Costruzioni Generali
- Saudi Benladden Gr. (Mimar), Cairo
- SENCO & Co., Cairo
- Trafalgar House

The same Decision Making Committee (DMC) of Phase I selected ten joint venture international contractors to compete for the tenders, after a careful study of their documents. The finalist tenderers submitted their offers in May 1996:

- Balfour Beatty Int./The Arab Contractors Osman A.Osman
- Daelim Industrial Co.
- Doosan Construction and Engineering
- Dragados Construction Egypt, Hochtief, Egypt Branch
- Kajima Corporation
- Trafalgar House



Phase I, Site Mobilization

The Decision Making Committee held many meetings in Alexandria at the Executive Secretariat offices and reached their recommendation to select Balfour Beatty (British 45%), and the Arab Contractors (Egyptian 55%) (BB/AC) as the best offer both technically and financially. Balfour Beatty was specified in the tender as the joint-venture technical leader. The technical input and professional participation of the Consultant in the lengthy deliberations were especially enlightening.

The contract award ceremony was held at the Ministry of Higher Education in Cairo on 7 December 1996 for a contract value of US\$ 117.6 million, which was the lowest bid. The contract duration was 860 days, with a two-month early completion offered by the joint venture, which was one of the main points in their favorable selection. The positive aspect offered by the Balfour Beatty/Arab Contractors ensured the continuity of responsibility, legally, professionally, and technically, since the Arab Contractors was also involved and responsible for the construction of Phase I. It was important in all contracts of joint ventures that the parties were jointly responsible for the contract obligations and commitments. It was wise to have a period of nearly two weeks overlap between the contractors of Phase I and Phase II to ensure a smooth transfer and continuity of operations of systems at the site.

In both Phase I and Phase II the Snøhetta/Hamza Consortium represented by Hamza Associates as Resident Engineer participated in decision meetings and submitted their evaluative reports and recommendations to the Decision Making Committee (DMC) for consideration.



Excavation

Subcontractors

The architects, engineers and the contractors for the building phases could not have completed their work without the support of many proficient subcontractors that supplied all the parts, pieces and additional expertise to complete the building according to specifications. Major subcontractors were entrusted with the implementation of the Planetarium, stone works, the roof, partitions and cladding.

The consortium engineers prepared the technical side of the work for the designers. This included the electrical and heating/cooling/ventilation. There were lighting designers, acoustical engineers, fire and life safety, as well as security to be considered.

Several workshops were held during the early Project work for the contractors and subcontractors to learn about new techniques and tools, and to transfer expertise to the local companies. One of these was for the stone quarrying and cutting. The good merger of all these companies resulted in the magnificent realization of the New Bibliotheca Alexandrina.

PHASE I Execution

The foundations and geotechnical engineering contractors, Rodio/Trevi (Italy)/Arab Contractors (Egypt), began the construction work on 15 May 1995 and completed it on the 31 December 1996 at the cost of US\$ 59 million. The construction work involved the most advanced techniques and technology. The work essentially included the largest circular reinforced diaphragm wall in the world of a 160 m diameter, which was a major engineering achievement, along with more than 600 bored bell-bottom piles.

Foundation and Ground Engineering

The design concept, the critical ground conditions and the aggressive saline environment, due to the closeness to the sea, required remarkable foundation and ground engineering works. These mainly consisted of:

- An additional soil investigation to accurately define the local geotechnical features of the ground, and consequently the operative design review;
- Reinforced concrete diaphragm walls, for a total of about 28,100 m², at the perimeter of the Library and of the Planetarium structures, deepen to -33.5 m and -27 m respectively, to allow the ground excavation and to integrate the underground structure;

- 602 bored piles to a 41 m maximum depth, apt to support the compressive and tensile foundation loads;
- Soil improvement by jet grouting to ensure the suitable geotechnical features in the area between the Library and the Conference Center;
- Dewatering interventions apt to ensure the “dry” ground excavation and the construction of the structures designed below water level;
- Soil excavation and, for the Library, construction of a waterproofed and reinforced foundation slab, 1.2 m thick, linked to the piles head.

Excavation

The excavation of the sand formation, down to 14.4 m below the working platform, was completed in about two months. A total of about 250,000 m³ was moved and conveyed to the landfill, by back hoes and trucks working 24 hours per day. Where the top layer of the rock formation was too hard to be excavated by the backhoe equipment, the material was ripped up by a dozer.

The excavation was complicated by the presence of the hanging cages of the piles and by the casings of the dewatering wells. After the accurate trimming of the pile heads concrete by pneumatic hammers, the relevant surface was made smooth by a mortar layer, to allow the proper installation of the HDPE waterproofing membrane.

Soil Investigation

An additional soil investigation was performed, to define in detail the geotechnical features both in terms of mechanical properties and permeability. The investigation included:

- Thirteen cored holes, 40 m deep, systematically tested by pressure meter;
- Sixteen Electric Cone Penetration tests and 16 Dilatometer test, 15 m deep;
- About one hundred Lugeon water tests;
- Three pumping tests in an undisturbed soil condition, each one carried out through a 30 m deep, 400 mm diameter well and piezometers;
- Seven pumping tests performed after the execution of the foundation works (after the diaphragm wall closure).

The ground conditions, which proved to be substantially uniform throughout the site, are the following (from the working platform located 2 m above sea level):

- +2.00 to + 0.50 m Fill
- 0.50 to -12.00 m top sand (loose to medium dense silty sand)
- -12.00 to -19.50 m upper rock (olitic limestone/calcareous sandstone)
- -19.50 to -23.50 m Middle sand (medium dense to dense silty sand)
- -23.50 to -44.00 m Lower rock (calcareous sandstone/sandy limestone)
- Below -44.00 m Bottom sand.

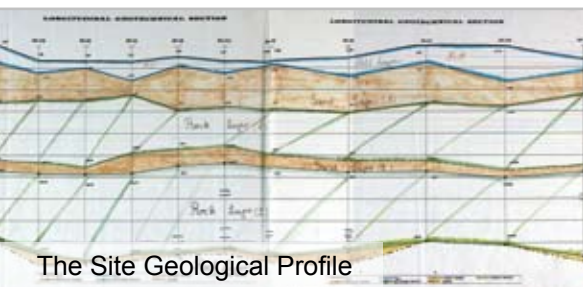

The collected data were utilized for the final design review.

Diaphragm Wall

The groundwater level is 11 meters above the lowest basement slab level. The designer, Snøhetta/Hamza Associates, briefly considered constructing the basement within a circular sheet pile cofferdam to resolve the problem. The vast building size ruled out internal propping and Egyptian law would have banned the use of ground anchors beneath the existing buildings in close proximity. Therefore a bold decision was made. A diaphragm wall believed to be the largest ever attempted, was constructed to a total depth of 35 m. The wall was continuously reinforced without joints, a technique that has never before been tried outside the Far East.

The revision of the diaphragm wall's operating design was included in the contractor's duties. An accurate check through a 3D finite element structural analysis was performed, including the detailed simulation of the construction steps, of the subsequent excavation phases and of the final structural behavior. The precise construction design of all the geometrical and technological features of the Library diaphragm wall structure, mainly for the "T" panels and for the steel reinforcement general layout, were accordingly defined. In particular, for the "T" panels designed on the Conference Center side, it was precisely established that:

- The general layout of the panels (number, shape, location);
- The geometrical shape of each transversal web;
- The dimensional statement and the configuration of the reinforcing steel cages and their assembly methodology;



- The pre-stressing amount and the consequent number and path of the pre-stressing cables.

Furthermore, at the ends of the straight diaphragm wall structure in front of the Conference Center, special structural diaphragm wall (d.w.) “boxes” were inserted.

There are two additional reinforced-concrete walls on the interior of the diaphragm wall. One of these two walls stops at the ground level and is separated from the diaphragm wall by a continuously drained waterproof membrane; this is the outer wall. It carries vertical loading from the basement floors and is capable of resisting water pressure should the diaphragm wall leak at any stage during the structure’s 200-year life expectancy. In some areas the outer wall is restrained from lateral movement by the floor construction, whereas in others, cross walls link it to the second, or internal, wall. The internal wall is a partially sunken cylinder that creates a circular plan shape and supports etched granite cladding panels.

The diaphragm walls were built through a sequence of primary and secondary panels. The excavation of each panel was performed by a Hydromill rig. At the Library perimeter, where the continuity of the horizontal reinforcement was required, in the primary panel two steel end plates were welded to the cage to confine the subsequent concreting. The horizontal reinforcement was extended outside the end plates, to allow splicing with the specially designed secondary steel cage later on installed. Canvas was accurately connected to the primary panel end plates to provide maximum protection against leakage of concrete beyond the plates. At the Planetarium, the clear distance between primary panels being 2.6 m, the tool milled a 0.1 m primary panel concrete portion on each side while executing the secondary panel, thereby assuring the foreseen watertightness to the joint.

Due to the critical ground conditions, the complex required extensive foundation and ground-engineering work, including excavation, dewatering, bored piles, and jet grouting improvements. All of the geotechnical work was performed from a working platform two meters above sea level. The groundwater table was below the working platform and was influenced by the minimal sea tide.

The earth and water retention required for the deep basements has been accounted for by the diaphragm wall construction. The diaphragm wall design, the reinforcement of panels is affected through discrete vertical cages with no connections between the reinforcement of the adjacent panels. When the soil inside an unsupported, unanchored wall is excavated, the wall acts, in effect, like a series of individual cantilevers. Unless these concrete cantilevers are very thick and very heavily reinforced, water leakage can occur. Hence, the innovative idea of constructing a circular wall that would have

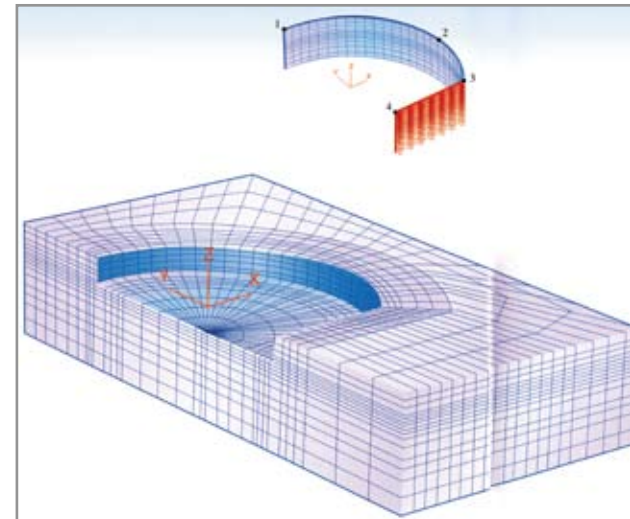

continuity in its horizontal reinforcement, looked very promising. This wall would act like a homogeneous cylinder, resisting outside earth pressure through the development of hoop stress. The wall would be a much more efficient structure and would significantly reduce the weight of the reinforcement.

Bored Piles

Because of the asymmetrical design of the internal superstructure, variations occur in the intensity of loading to the piled raft. Large dead loads occur to the south of the site, placing the piles in compression. At the north section of the site tension piles are necessary to account for the uplift created by the water pressure as a result of minimal dead loads. In the central area of the site, the piles are in tension or compression, depending on loading conditions. There are 131 piles, 1,500 mm in diameter with a single underream, or bell-shaped bottom, that are mainly under compression; 325 piles 1,200 mm in diameter with two underreams that are mainly under tension; and 143 piles 1,000 mm in diameter with two underreams that can be under compression or tension.

The compression and compression/tension piles were arranged in a grid of 4.8 by 7.2 m. The tension piles were arranged in a grid of 4.8 by 4.8 m. All the piles were reinforced along their full length. In the compression piles, however, the amount of steel was reduced in the lower half of the pile.

Piling was carried out to very tight limits. Steel castings were driven down to limestone before boring commenced. An innovative feature of the piling operations was the underreaming tool used, perhaps the first ever to feature hydraulic operation and a readout of depth and diameter. The single or double underreams it produced were checked for shape by an ultrasonic profiler developed in Japan by the firm Kodan. This assessment also gave a quick readout of the alignment and cross section of the main shaft before the reinforcement cage was lowered. Sonic integrity testing was carried out after the concrete was placed by means of steel pipes cast into the piles. Where any defects were discovered, holes were drilled through the pile to the level of the defect and the resultant void was grouted. The pile was then retested.

Due to the Library structure shape, severe eccentric gravity loads are transmitted to the foundation. The foundation raft design, which was verified through a three-dimensional Finite Element Model under various load combinations, including wind, earthquakes and water uplift, implies the transfer of the loads to a piling system. Unfortunately, the building is not a complete circle in its plan. In the straight part of the wall parallel to the Conference Center side, vertical prestressing was used to guarantee water tightness and reduce the amount of vertical reinforcement to values that ensure the



Steel Cages

quality of the concrete work. At the junction between the circular and straight sections, the large hoop forces required box-type wall segments to safely transmit straining actions between the two parts. In addition, the segments of the circular part near the junctions were to be stiffened by webs.

The bored piles were consequently designed and built, starting from the working platform, with the technological features apt to guarantee the proper behavior of the foundation for the foreseen 200-year structural life.

Soil Improvement

The complex grouting operation began within a few hours of the concrete placement. The aim of the grouting was to improve the base-bearing and the shaft-bond capacity. French style “tubes à manchette” were used. Each pile had four plastic tubes cast into the concrete cover zone, and each tube was drilled with four circumferential holes every 500 mm along its length. These holes were sealed with rubber collars, and the tubes were connected in pairs to form flat U shapes at the bottom of the piles. Pumped water broke the collars and cracked the concrete cover. Grout then flowed between the pile and the surrounding shaft. The grout also filled any fissures in the sandstone and limestone and ensured contact between the concrete shaft and the surrounding concrete. The bases of compression piles were grouted by connecting the grout tubes to the base.

The compression/tension piles were arranged in a grid of 4.8 by unisom piles. All the piles were reinforced along their full length. In the compression piles, however, the amount of steel was reduced in the lower half of the pile. To enhance the pile capacity, one or two bell enlargements were carried out in the calcareous formation.

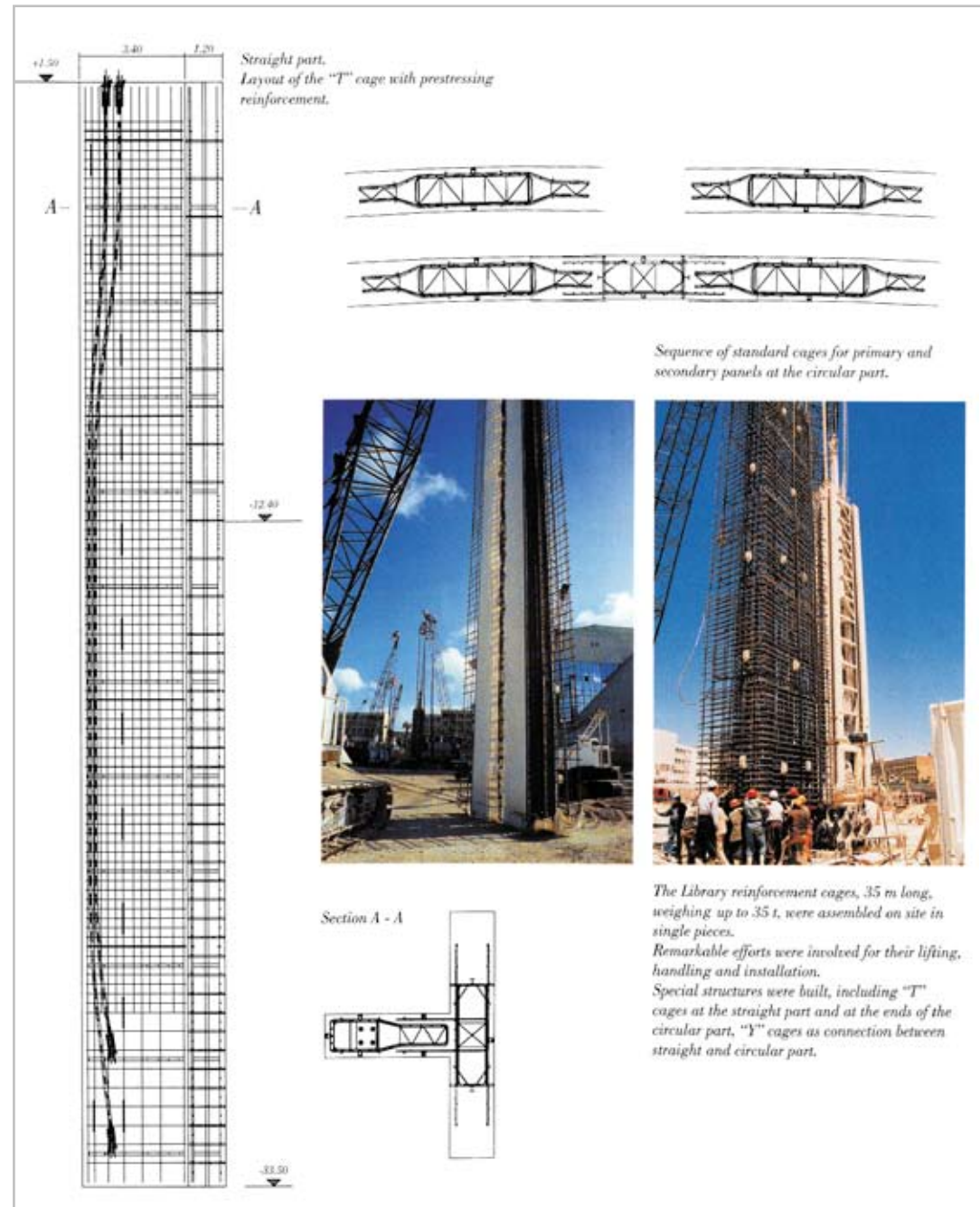

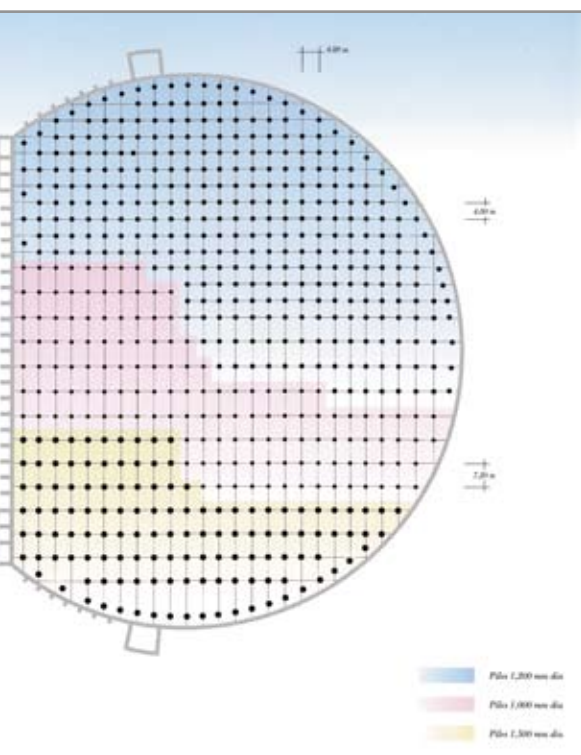

In addition, to improve the concrete/rock interface friction value, pressure grouting was systematically performed after concreting.

Raft

The Library superstructure consists of a reinforced-concrete frame comprising a flat floor of 400 mm deep waffle (ribbed or hollow-block) slabs, with ribs at 1,000 mm centers. The ribs extends to central hidden beams that are 400 mm deep, which in turn extend to columns and walls at 7.2 and 9.6 m centers. At the lower floor levels, where heavy live loads are applicable, the floor construction relies on 600 mm deep waffle slabs with corresponding 600 mm deep hidden beams. Reinforced concrete walls were incorporated into the construction to account for the lateral loading associated with wind and earthquakes.

The 17,700 m², 1.225 m thick, bottom raft of the Library was constructed in each of the 54 scheduled sections already lined with waterproofing membranes through:

- The preliminary positioning of the reinforcement system, mainly consisting of two double layers of 40 mm diameter crossed steel bars (0.35/t/m²), carefully linked to the piles top cages.
- The pouring of the concrete (28 days characteristic strength of 45 MP made with high slag blast furnace cement), by means of truck mixers, concrete pumps, tower cranes, pencil electrical vibrators and specially designed belt conveyors.

The work was fulfilled in a period of two months, through production rates of more than 150 t and 500 m³ per working day, respectively for reinforcement and concreting.

The thickness of the raft supported on the compression or the compression/tension piles is 1,275 mm. The raft was connected to the fourth basement slab by a system of vertical webs and short columns. The space between the top of the raft and the bottom of the fourth basement slab is 1.6 meters, and has been left open for future inspection. To reduce the amount of tension in the tension piles, additional load has been incorporated into the structure by increasing the thickness of the raft from 1,275 to 2,400 mm in the area where the raft is supported on tension piles. The increased raft thickness also increases the flexural capacity of the raft in case any damage occurs to the tension piles in the future. To minimize the bending in the raft, all of the supporting columns are lined up nearly vertically with the piles in a one-column/one-pile manner. The shear walls

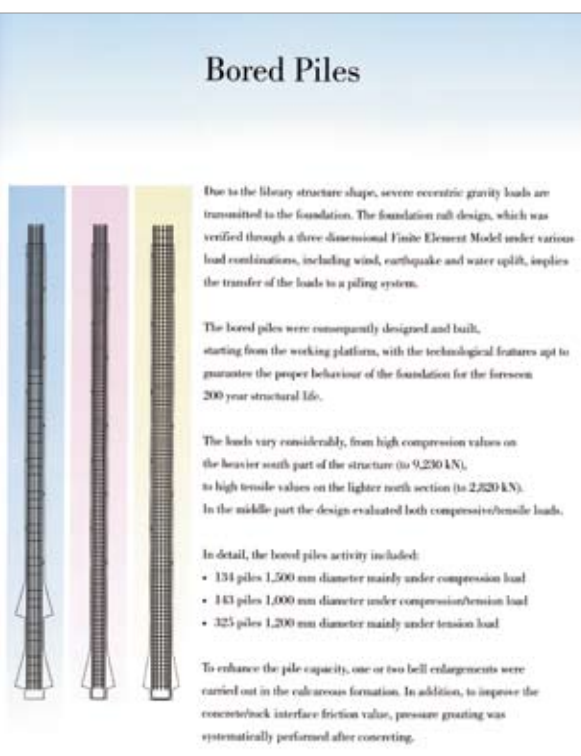

and cores, however, transmit their loads indirectly to the supporting piles through the bending action of the raft.

The reinforced concrete raft was cast on top of a 200 mm thick raft of plain concrete on which a waterproofing membrane had been placed. The raft is structurally separated from the diaphragm wall. To ensure full insulation for the Library building, the edges of the raft are connected to the outer wall. The outer wall is connected to the diaphragm wall by a very stiff capping beam to ensure that the diaphragm wall works together with the other elements of the building in resisting any actions caused by earthquakes.

Several tests were executed during the Phase I construction to determine the buildings earthquake proof capacity, and the strength of the pile foundations. This was interesting because it required the importation of dynamite by the RTA contractors for the tests, and also required special permission from so many government authorities to conduct the tests, including the Alexandria Governorate, the security authorities, the military, the Ministry of Higher Education, the Ministry of the Interior. The tests were performed in Fall 1996 without any negative incidents of concern to the relief of everyone.

Waterproofing

Due to the critical ground conditions, the complex has required extensive foundation and ground engineering work, including excavation, dewatering, bored piles, and jet grouting improvements. All of the geotechnical work was performed from the working platform at 2 m above sea level. The groundwater table is about 1 m below the working platform and is influenced by the sea tide.

The inner face of the diaphragm wall is covered by High-Density Polyethylene (HDPE) sheets. The fact that about one-third of the total number of piles will be permanently subjected to tension created a challenge, especially when a life span of 200 years was considered. Part of the solution involved limiting of the widths of potential cracks in the tension piles by limiting the stresses in the steel reinforcement. Special care has been taken to ensure that the connections between the tension piles and the raft foundation are watertight. All steel rebars in the top 1.2 m of the piles were placed inside HDPE sleeves with cement, unshrinking grout in the space between the bar and the sleeve.

The horizontal and vertical waterproofing of the underground surceases were obtained by the combined action of HDPE sheets, jointed by welding, and a special waterproofing liner made of dry betonite sandwiched between two geotextile fabrics. The starter bars crossing the waterproofing layer

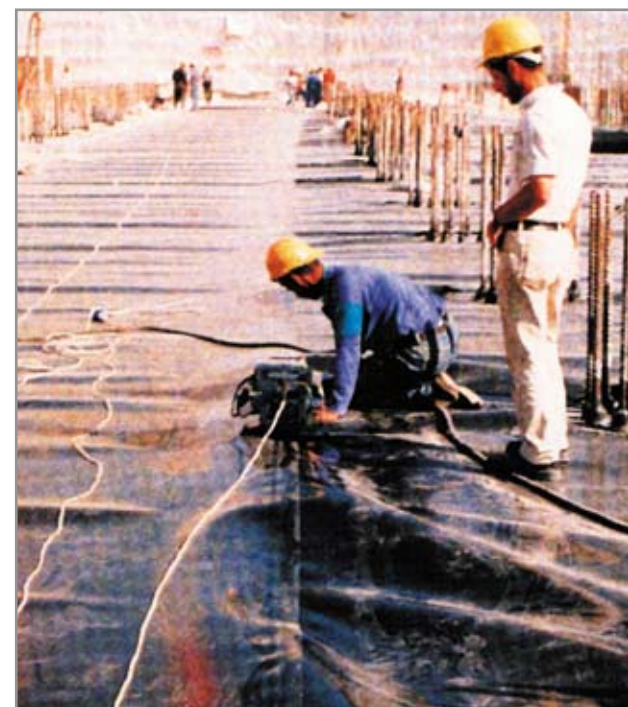

Raft Insulation

were lined with HDPE sleeves cemented by a non-shrinking mix. The continuity of the treatment was achieved by welding specially designed HDPE square membranes to the sleeves.

Insulation of a Water-tight Structure

The earth and water retention required for the deep basements has been accounted for by the diaphragm wall construction. The diaphragm wall extends to the sandstone at a depth of 35 m. In conventional diaphragm wall designs, the reinforcement of panels is effected through discrete vertical cages with no connections between the reinforcement of the adjacent panels. When the soil inside an unsupported, unanchored wall is excavated, the wall acts, in effect, like a series of individual cantilevers. Unless these concrete cantilevers are very thick and very heavily reinforced, water leakage can occur. Needless to say, the innovative idea of constructing a circular wall that would have continuity in its horizontal reinforcement, looked very promising. This wall acts like a homogeneous cylinder, resisting earth pressure through the development of hoop stress. The wall is a much more efficient structure and significantly reduces the weight of the reinforcement.

The interface of the diaphragm wall is covered by High Density Polyethylene (HDPE) sheets. The fact that about one third of the total number of piles will be permanently subjected to tension created a challenge, especially when a life span of 200 years was considered. Part of the solution involved limiting the widths of potential cracks in the tension piles by limiting the stresses in the steel reinforcement. Special care was taken to ensure that the connections between the tension piles and the raft foundations were watertight. All steel rebars in the top 1.2 meters of the piles were placed inside HDPE sleeve with cementations, non-shrinking grout in the space between the bar and the sleeve.

Unfortunately, the building is not a complete circle in plan. In the straight part of the wall, vertical prestressing was used to guarantee watertightness and reduce the amount of vertical reinforcement to values that ensure the quality of the concrete work. At the junction between the circular and straight sections, the large hoop forces required box-type wall segments to safely transmit straining actions between the two parts. In addition, the segments of the circular part near the junctions needed to be stiffened by a web.

Features of the Project

The fulfillment of the wide Foundation Project, characterized by an over-refined technical degree and a tight time schedule, required an exceptional engagement in terms of human and material resources.

Technically, it has to be pointed out that some advanced technologies, especially for the piling and the diaphragm walling activities, were for the first time adopted on a large scale and verified under a strict Quality Control System.

An idea of the considerable human effort and of the material involved can be gathered from the following data:

Personnel on site:	Engineers and staff	135
	Foremen and skilled personnel	407
	Laborers	355
Main material:	50,000 tons of cement	
	12,000 tons of steel reinforcement	
	75,000 m ³ of concrete	
	25,000 m ² waterproofing liner	

One of the main factors contributing to the success of the Project was the active collaboration between owner, engineer and contractor, and the ability of the different nationalities involved, at every level, to work harmoniously together. Finally, it has to be underlined that, due to the careful site organization, no serious injuries were suffered from the personnel in the course of work.

PHASE II The Superstructure

Despite the fact that the Library building has floors with very large spans and walls that have a perimeter of about 570 m, no expansion/contraction joints were provided. This required the designers to conduct a sophisticated thermal analysis, one that regarded the entire building as a single unit under the effect of uniform as well as nonuniform changes in temperature. A three-dimensional finite-element computer model was developed to idealize the Library building, the raft foundation, and the piles. Three-dimensional shell elements were used to model the raft, the floor slabs, and the walls. The columns were modeled using three-dimensional frame elements. The piles were modeled using one-dimensional spring elements. The stiffness of the piles varied depending on the diameter of the pile and on whether it was subjected to tension or compression.

Due to the necessity of providing large spaces that are free of columns, the spans of the Library floors are relatively large and the dimensions of the concrete columns are relatively small 1,000 mm in

diameter. Waffle slabs were used to cover the large spans. The small dimensions of the columns have been compensated for by increasing the amount of vertical reinforcement and using relatively high strength concrete. Shear walls and cores were designed to provide the required lateral load resistance.

It is only from the inside of the Library that the scale of the Project becomes apparent. Its tall, slender columns and high roof create a cathedral-like atmosphere. The elimination of columns in some floors required the use of hangers with which the floors above are supported. A sophisticated structural analysis was required to examine the stability of the structure supported on reinforced concrete hangers under various load cases. The concept of having alternative load paths was also adopted in such cases. Should the hangers fail, the hanging floor will still be stable, but it will suffer some serviceability problems, such as deflections or cracks. These problems, however, will be correctable.

The columns supporting the roof of the Library are spaced on a grid of 14.4 by 9.6 m. These columns, including capitals, are up to 16 m in height and 70 cm in diameter. They are rigidly connected to their lower ends and restrained from lateral movement by the roof girders at the top ends. Column capitals are precast on the ground, lifted to their specified position on top of the cast columns, and are rigidly connected to the columns by welding around the steel base and sole plates.

Roof Construction

The roof design proved extremely complicated to manufacture and erect. Only after the erection of a full scale mock up in the factory in Austria, which included a complete water test, was the design accepted for constructability. The tolerances were very tight from bay to bay and resulted in extraordinary precautions during the erection of the concrete beams.

The roof structure is composed of precast girders of reinforced concrete weighing up to 18 tons and a diagonal secondary steel system to support the roof glazing and cladding. The girders are simply supported on column capitals in the form of a grid 14.4 by 9.6 meters grid. They are fixed to the column capitals by a single anchor that permits rotation at the supports and eliminates temperature effects, thus doing away with expansion joints in the 160 m diameter circular roof.

The Concrete Frame

The construction of the large precast beams that form the roof panels of the circular building involved precasting 20 ton units at the point of lifting together with 10 ton capitals that sit on the top of the

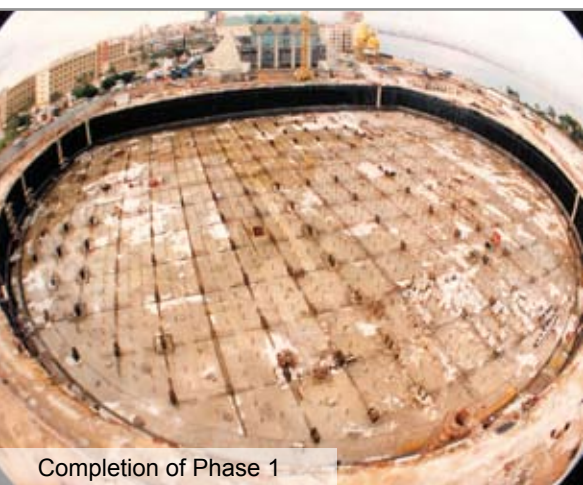

Completion of Phase 1

slender columns. The main problem was the fact that the tower cranes are only capable of lifting three tons at the end of the jib. Thus, the Engineer had to come up with some way to lift 20 tons at all points of the building, remembering that the building is some 160 m in diameter. This was solved by having specially manufactured small cranes each capable of lifting 11 tons, but mountable into 3 tons components so that the tower cranes could lift them to all areas of the building. Each small crane was positioned at the main columns and bolted down through the concrete floor slab and strapped to the *in situ* column for stability. The precast beams on stripping from the mould were then in the correct position to lift into position using both cranes working in tandem. This was a very delicate manoeuvre and one that had to be repeated over 300 times to position all the precast beams.

Precast Cladding Panels in the Reading Hall

The precast panels are all concrete with sound attenuation holes cast in regular intervals, to an individual radius to fit the perimeter wall of the building. This necessitated the design of very special moulds to accommodate the changing radius and we solved the high concrete finish and variable moulds by working closely with a concrete pipe manufacturer in Cairo.

After casting, the panels were erected onto a steel framework attached to the outer walls. The gap between the wall and the panels was approximately 3 m and this was utilized to accommodate the M&E services and large AC ductwork required for the main hall. This looks very simple now it is in position, but the calculations required to meet the tight tolerances were undoubtedly one of the most challenging aspects of the entire project.

There are two additional reinforced concrete walls on the interior of the diaphragm wall. One of these two walls stops at the ground level and is separated from the diaphragm wall by a continuously drained waterproof membrane— this is called the outer wall.

The outer wall carries vertical loading from the basement floors and is capable of resisting water pressure should the diaphragm wall leak at any stage during the structure's 200-year life expectancy. In some areas the outer wall is restrained from lateral movement by the floor construction, whereas in others, counterfort cross walls link it to the second or internal wall. The internal wall is a partially buried cylinder that creates a pan shape and supports the engraved granite-cladding panels of the external wall.



Planetarium under Construction

The Planetarium

The design of the adjacent Planetarium suggests a planet in space. The structure was therefore designed as a complete sphere, 18 m in diameter, suspended in air. The upper two-thirds of the sphere is projected above the ground level, while the lower third is hidden inside a 24 by 24 m pit with the bottom slab 13 m below the center of the sphere. The sphere hangs from two orthogonal through-type bridges used for visitor access to the facility. The bridges are supported on top of the reinforced-concrete walls of the pit. The access and stage floors of the Planetarium are located at the levels of the bottom and top chords of the bridges, respectively. The sphere cladding is constructed of black-striped lightweight precast glass-reinforced cement plates, while the bridges are clad with silver aluminum.

The structure of the sphere is built up from steel tube members connected to one another by patented ball joints. Each of the two bridges spans 24 m, with their two girders 3.1 m in height and spaced 2.4 m apart. Each girder is a combined truss/Vierendeel system, with the diagonal members inside the sphere eliminated to make the space in the access floor usable. Each girder has one restrained and one movable neoprene bearing. The members of the main girders have closed box cross sections. The two girders of each bridge are connected horizontally by bracing members in the planes of their top and bottom chords.

The transfer of loads from the sphere to the bridges is through two horizontal, circular ring beams provided at the levels of the top and bottom chords. The upper part of the sphere rests on the top ring beam while the lower part is hung from the bottom ring beam. The two ring beams are interconnected by tubular members to complete the sphere and to form a circular steel deck. The deck is supported on traditional secondary beams carried by the bridge chord members and the ring beams. The complete steel structure including the members of the geodesic sphere, the two horizontal circular ring beams, and the four truss/Vierendeel girders was analyzed by the finite element method. Static and dynamic analyses were carried out.

Quality Control

The highest quality control and quality assurance standards were followed throughout the construction of the Library. Each component of the construction was built as a test model first and actual construction only began after meeting rigid construction standards and going through suitable testing.

Some advanced technologies, particularly for the bored piling, the diaphragm walls and the roof construction were adopted under a strict quality control system. Due to special static requirements, the

horizontal continuity of the reinforcing steel between the concrete panels of the diaphragm wall had to be ensured.

For example, a total of seven Statnamic tests at the site of the New Library of Alexandria (Bibliotheca Alexandrina). The tests were conducted during 11 days using an 8 MN Statnamic device (supplied by TNO). The Statnamic testing was performed much faster than it would have taken to perform seven static load tests, and the consultant was given the opportunity to select the test piles after they were installed. On this project Statnamic provided an excellent method of quality control.

The site can be considered of the highest quality anywhere in the world. Many of the constructions are monumental in scale and complicated in nature.

Landscaping

The Architects, Snøhetta a.s., also carried out the landscaping of the site, carefully considering native plants and using plant life to help clean the site from the build up of dirt and bacteria in the water pools.

The Plaza of Civilizations is wide and inviting, and allows for multiple uses when the need arises, such as for performances and other cultural events. The twelve olive trees in the Plaza are symbols of longevity and hope for peace and a reminder of its significance and symbolism as reported in the Koran, such as in *Sura Nur* 24:35 and *Sura El Teen* 5:1, which refers to the Prophet Ibrahim, the father of the three great monotheistic religions. This tree possesses a wealth of symbolism - peace, fruitfulness, purification, strength, victory and reward. In ancient Greece, the tree was sacred to Athena and the first olive, which sprang from her quarrel with Poseidon, was preserved as a treasure behind the Erechtheum. In Jewish and Christian traditions, the olive is a symbol of peace; it was an olive-branch which the dove brought back to Noah when the Flood was over. Furthermore, old legend has it that Christ's cross was made of olive and cedar-wood.

A row of palm trees, a regional tree, was planted parallel to the northern boundary facing the Mediterranean, in addition to boxes of papyrus plants in the southern reflection pool facing the historic land of Egypt, where the ancient Egyptians used the plant in making the first papyrus scrolls to record their history and civilization .



Planetarium under Construction

The Stone Wall

The idea of the art work on the exterior wall came early on in the Competition. As all natural light to the Library falls through the roof, the external wall can be continuous and windowless, as an independent work of art, signaling the function of the library. The carved wall contains no sentences or stories, just the characters of all cultures and epochs of mankind.

The exterior of the new Library presents a monochromatic expanse in the form of the cylinder's perimeter wall; the outer wall as it rises above pavement level. Far from being a smooth metallic, high-tech skin, this is a curving cliff face of roughly cut gray granite quarried in Egypt south of Aswan. The only interruptions in the granite face are the large letters that have been carved into its surface. To symbolize the world multitude of cultures, the letters have been taken from as many alphabets as could be found.

Jorunn Sannes, the artist, worked to collect the characters and signs made by mankind throughout time, and then digitized them since there was no central database of known written languages. Through this process all the characters found their place on the wall, and the digitalization process opened the use of a computer-controlled diamond cutter to outline the symbols in preparation for hand-carving. The characters are out of context, and are without related meaning. They speak for themselves, with their own symbolism, simplicity and originality. There is no cultural, language or time limit to the elements.

The granite panels are 1 x 2 m and 1 x 1 m and 15-20 cm thick. As they have been split by hand, they have a natural rough texture, which enhances the expression of massiveness and allows the carved characters to spread. Prototypes were made in Norway and the main carving techniques decided. Then the characters had to be collected and digitalized, a difficult process, as there is no central database of all known written languages. But slowly all characters found their place on the wall, and the digitalization opened for the use of a computer-controlled diamond cutter to outline the symbols in preparation for hand carving.

Through a long selection process an Egyptian quarry, Granite of Aswan, was chosen for delivery of the Grey Schulman granite and production of the panels, and a test wall of 100 m² was quarried and carved. The local stonemasons were experienced craftsmen, but clearly found themselves faced with an unfamiliar task, and new unfamiliar tools such as angle grinders and pneumatic hammers. To improve communication Norwegian and Swedish masons worked alongside them throughout the fabrication



The Stone Wall

process, a training program funded by NORAD, transferred this knowledge to the Egyptian workers. In fact a special workshop was held in Norway for their benefit so that they could see first hand new techniques that would be applicable to their applications in Egypt.

At the end of the two year long process, the young masons had carved a total of 6000 m² of stone paneling and 2400 tons of stone were mounted on the building. A seemingly impossible project had been realized.

Transfer of Technology

This was a tremendous investment on the part of Egypt, but has served the country well in the amount of technology transfer, training and raising of the standards of construction throughout the country. The use of new equipment like those used for the piles, and new techniques like those used for the roof construction, required extensive training for all the trades, from bricklayers and plasterers to crane operators. This also benefited the specialist subcontractors (Planetarium, Roof cladding, Curtain walling, and External wall cladding) who had to provide services, equipment and materials for the site, as well as all the other sub-contractors who provided a myriad of materials. The quality of materials used had to perform at high standards and meet essential testing requirements.

After Completion

The new building complex of the Bibliotheca Alexandrina has received world acclaim by professional associations, syndicates, engineering and architectural forums, institutions and magazines not to mention the international media. I am happy to report that having been one of the nominators of distinguished buildings in the Middle East for the Aga Khan Award for Architecture since I was Dean of Architecture at Beirut Arab University in the late 1970s, I nominated the Bibliotheca Alexandrina to be considered for the Award. I wrote my nomination to Suha Ozkhan, Secretary General of the AKA in June 2002 for consideration for the Award in its Ninth Cycle (the 2002 Award). The Project given reference 2725EGY was short-listed for the Jury consideration, and I was happy to meet Arch. Hanaa Alamuddin, representing the Award Committee, in Alexandria on the 24th March 2004, to answer her queries and give her a first hand briefing on the Project development. The Master Jury finally reached its decision in June 2004, and the Bibliotheca Alexandrina was on top of the list of the seven chosen projects for the 2004 Award from 378 nominated projects. Dr. Ismail Serageldin, Director of the Library, organized a special ceremony at the Conference Center on 23 December 2004

to honor those who helped in the realization of this great achievement from the owner, the consortium and contractors side.

It is fitting to refer to the Aga Khan Master Jury citation concerning the Bibliotheca Alexandrina:

“This building has received an award because it shows an innovative approach to the design and placement of a large, symbolic form on one of the most important waterfronts in the world. From its inception through an international competition to its design and construction by many international companies, and in its current financial management, the Project provides a model for other such projects in bringing together the international community and encouraging cooperation and commitment from society as a whole.

“While the building is ground breaking in architectural and technological terms, it also responds sensitively to a wide spectrum of issues, including politics, religion, culture and history. The bold ‘tilted disc’ forms an icon while delivering a highly formal and monumental building. The technical challenges of constructing such a large development close to the water’s edge and within an urban setting have been embraced and dealt with through the use of advanced technologies. The form also provides a clear organization and functions well for the rich variety of programs it houses, while acting as a catalyst for improvements throughout the city. Finally, the Project celebrates learning and brings knowledge to societies across all cultures, playing a crucial role in the progress of civilization..”



Planetarium



“ Political ideologies might separate countries, and economic interests may cause gaps among people, but culture alone is a unifying rather than a dispersing element. Human knowledge, which is the treasure from which we pay our contributions today, is the credit to our future.”

Suzanne Mubarak

Chair of the International Commission, at Aswan on 12 February 1990

“ A bit of fragrance always clings to the hand that gives roses.”

Chinese proverb

CHAPTER 9

INTERNATIONAL
CONTRIBUTIONS AND
SUPPORT OF THE FRIENDS
ASSOCIATIONS

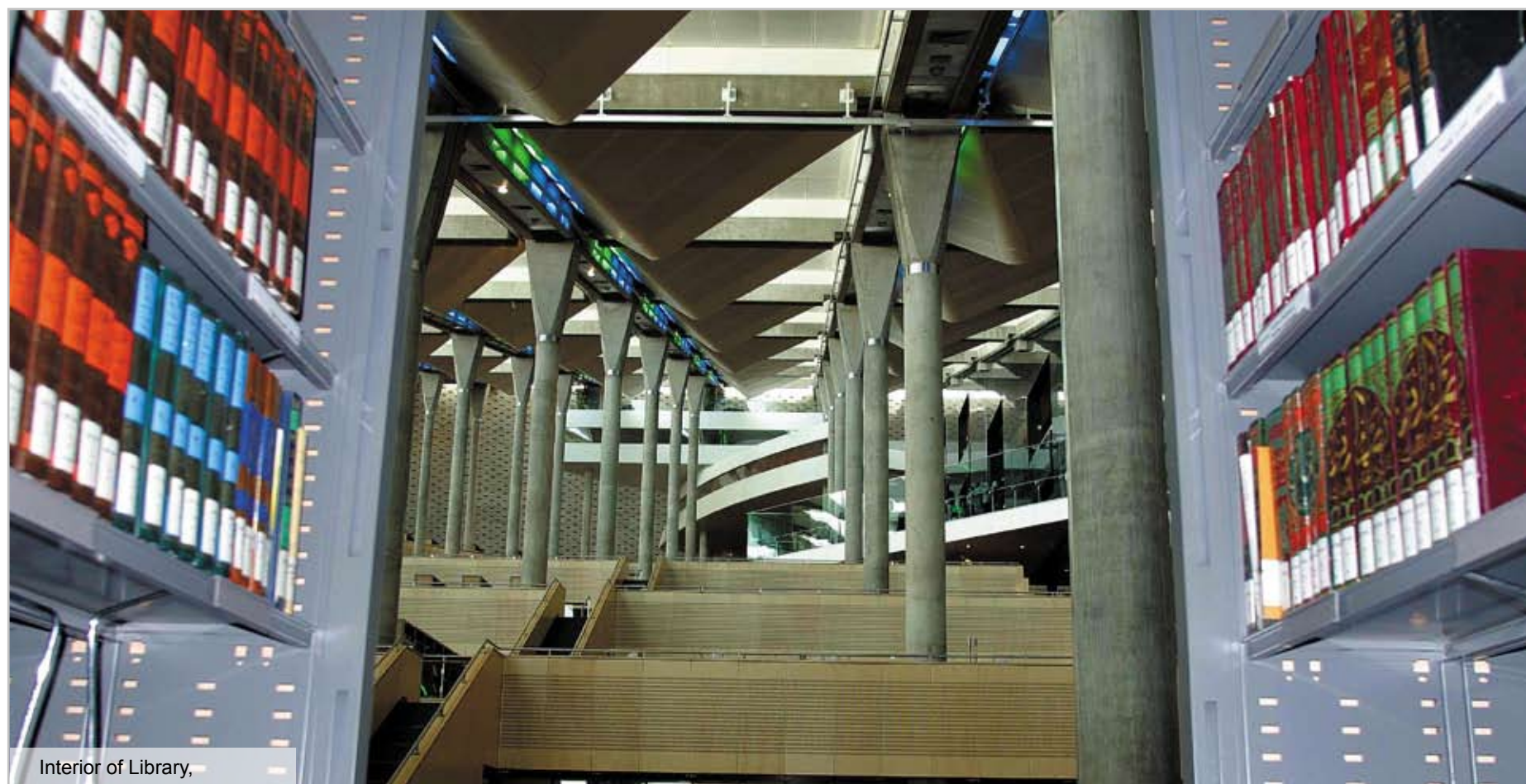

Interior of Library,

Since the beginning of the involvement and support of the international community, especially, UNESCO and UNDP to the Revival of the Bibliotheca Alexandrina, a multitude of visitors from all corners of the world were keen to visit the Project site in Alexandria and to follow up its progress and achievements. The unique concept of the New Library generated additional important motives for visitors especially in the architectural, construction, information, sciences, and technological fields.

President Hosni Mubarak honored the Project by his continued follow up of its progress, especially during his annual visit to the Conference Center, which was overlooking the site, before meeting with Egyptian universities leadership and student representatives.

This high patronage was coupled with the support from Mrs. Suzanne Mubarak, Chair of the International Commission, who visited the Project site several times during the construction period and chaired several international and national meetings concerning the Project development and follow up at the site. Without this strong patronage, partnerships, and contacts and support the Project might

not have reached its successful completion. Many dignitaries and prominent personalities from all over the world, including kings, queens, presidents, princes, prime ministers, ministers, international and national figures, made sure to come to Alexandria, especially to visit the Project site. The Project was a pace setter, a model for others to watch and follow, a locomotive in the urban and architectural development as well as an institution to train and uplift construction staff, standards and practice.

This interest and support was magnified and amplified by many international and national conferences and meetings held at the Conference Center after 1990 in spite of the feverish 24 hour ongoing construction activities. The unique design and unprecedented construction innovations especially created to meet special execution and strict specification requirements attracted the attention of engineers, builders, and contractors and professional publications worldwide. It also naturally attracted the attention and special coverage by international and national media, whose representatives in Egypt and abroad paid lengthy visits and conducted interviews with the Project personalities several times throughout the construction process.

International Governmental Support In-kind Contributions

Governmental and non-governmental organizations alike were inspired and motivated to contribute to the Project, especially after the “Appeal” from UNESCO. Their generous in-kind contributions were valuable and important in providing the needed furniture, equipment and book collections required for the Library.

1. The British Council provided training scholarships, books, experts and the unusual donation of the electronic music display (now in the Planetarium entrance) that should play 1000 years.
2. Canadian support came through officials of the Quebec Government. They, together with the Librarian of the Quebec National Library, were enthusiastic supporters of the Library. A protocol of cooperation was concluded between the two Libraries, according to which book donations were presented to the Bibliotheca Alexandrina, and internships were offered for our librarians. The Canadian Ambassador in Cairo, and Canadian ministers and officials paid several visits to the Library construction site and gave sizable book donations.
3. French support has never wavered since President Mitterrand signed the Aswan Declaration in 1990. France has provided scholarships for the Library staff to study at ENSSIB in Lyons, France; leading to Masters of Library Science degrees, and internships to various French libraries



Mohsen Zahran with Prince Henrik of Denmark



Norwegian Minister of Culture



Donation of Suez Canal Documents

for Library staff. In addition, France provided special financial support studies for the information system, and later for the EI Information System that was installed in the Library. France also supplied the History of Science Museum with the displays.

In addition, France provided the continuous support of Library experts to the Project and the Library. Mrs. Jacqueline Leroy, the Former Director of Library of Mines, assisted the Bibliotheca Alexandrina for two years as a Librarian in Residence, 1996-1998. Mr. Gerald Grunberg, Head of the Audio-Visual Department at the French National Library (BNF), became the second the Librarian in Residence and Advisor to the Project Manager for the Project, 1998-2000.

Mr. Grunberg started the in-house training program. Both Mr. Grunberg and Mrs. Leroy were a great help in locating French publishers to donate books, and selecting specialized collections for donation to the Library. Both of those outstanding personalities were great supporters in organizing and participating in many international seminars and conferences in Egypt and abroad. They were also of great help in persuading the French Government and specialized companies to support the information system at the Library (Cap Gemini for feasibility studies at FF 4.4 million grant, EI Audiovisuel for the information system valued at FF 38.5 as a low interest loan).

Jean-Marie Compte followed in their footsteps as Advisor on Library Affairs to the Director, and left to return to France only in 2004, after four years at the Library. France is currently providing an expert to work with the Director of the Library.

4. The German Government allocated DM 700,000 (about US\$ 350,000) to supply the Bibliotheca Alexandrina with the internal book transportation system (Telelift), in addition to valuable consultancies in the field of library management, services, the Library Internet portal, information technology and transfer of the Library collections to the new building. German institutions and companies also contributed two buses, funds, books, and furniture for the Young People's Library.
5. Through the generous support of the Greek Government and the Costopoulous Foundation the display cases of the Antiquities Museum were designed, manufactured shipped and assembled in place by Greek experts. The cooperation with the Greek Friends Association, and the Greek Egyptian Friendship Association, thanks to the efforts of Mrs. Anastasia Milopoulou and Mrs. Katerina Koskina, who made this in-kind contribution possible through a total donation of nearly 200 million drachmas (about US\$ 200,000).

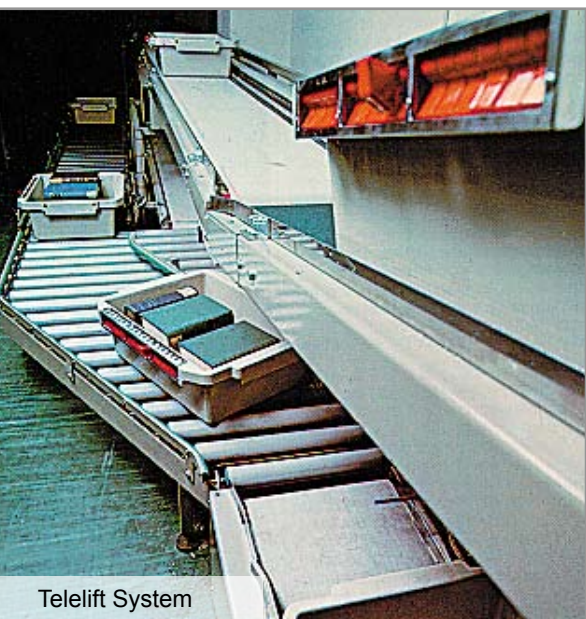

Telelift System

The Greek contribution also included a marble stella (with the names of the first Librarians of the Ancient Library), books and copies of sculptures of famous Alexandrian scholars. The magnificent statue of “Prometheus with Fire” that stands in the Plaza, was also a donation from Greece. The Alexander the Great statue was originally planned to be housed in an ornate marble rotunda at the Plaza of Civilizations, but when the statue was determined to be placed outside the Library premises the format of its presentation was also altered. It is now at the center of the Shallalat Square facing the original Shallalat headquarters.

6. The Italian Government supplied the Conservation and Restoration Laboratory equipment consultancies and training within the total donation of US\$ 400,000 through the first Trust Fund protocol with UNESCO (1994-1997).
7. The Italian grant was augmented by a second grant of US\$ 1 million by the end of 2000. This grant was designed to fully equip the Conservation and Restoration Laboratory, train its staff, and provide funds for museum quality showcases for the Manuscript Museum, and certain information technology. This was a multilateral project with greater Italian involvement than the earlier grant. The Italian side, UNESCO, and the Bibliotheca Alexandrina worked closely to coordinate and channel the funds to specific areas of need.
8. The Japanese Government through its Embassy in Cairo provided audiovisual equipment (Panasonic) to the audiovisual library in the amount of 50 million yen (about US\$ 500,000).
It provided a language laboratory, and audiovisual equipment for filming and viewing events at the Library.
9. The furniture was designed, manufactured, shipped and assembled in place through the generous support of the Norwegian Government, which amounted to nearly thirty million Norwegian Kroners (about US\$ 7,000,000 at that time).

These public area furnishings were designed by Snøhetta a.s., and provided a unique sense of balance, mixing the roughness of the external walls and the smooth forms set against strong lines. This was a magnificent cooperation between the Norwegian designer and the Norwegian manufacturer.

Furniture for the reading halls, and for the non-public areas, was made in Egypt using the funds given by the Egyptian Government. The Egyptian manufacturer was selected by following



standard contract procedures and followed the same rigorous design specifications as required by the Norwegians.

10. From the onset of the Project and prompted by the UNESCO “Appeal”, significant book gifts arrived from the international community, from nearly every country in the world. These came from government institutions such as national libraries (like the Library of Congress and the French National Library), as well as from organizations, academics, professionals and individuals. These were gratefully received at the New Library, and recognized in the GOAL quarterly newsletter, and by letters of thanks. Many of these donations were very thoughtfully planned according to the guidelines developed by the ES staff. Other donations were part of an exchange program between libraries that still exist to this day.
11. In cooperation with UNESCO, the Arab Gulf Fund and the Islamic Conference, it was possible to provide equipment and training of staff for the Visually Impaired Library amounting to nearly US \$80,000.
12. The Arab League in Cairo provided expert consultants in library affairs, and book contributions especially donated by the Secretary General, Esmat Abdel Meguid in 2000.



Former President of Greece

The International Dimensions of the New Bibliotheca Alexandrina

Through the experience of the management of the Bibliotheca Alexandrina during the last sixteen years, especially after the historic meeting in Aswan, many organizations, institutions and individuals were especially inspired by and contributed to the Revival of the Bibliotheca Alexandrina. It is of special significance and insight to focus on the efforts and dedication of the non-governmental organizations and individuals, who devoted time and effort with unequalled dedication to the cause and support of the New Library. They have become like beacons and nodes of networks, covering the corners of the universe.

Upon the international call made by UNESCO in 1987, groups and individuals rallied to support the Egyptian Project. Interestingly, many of the Friends Associations have actually been founded by “Alexandrians” or expatriates who have lived outside Egypt for one reason or another. Their support and loyalty to their motherland is one of Egypt’s greatest legacies to the world.

The Alexandria Friends Association

In direct response to the UNESCO appeal, the first non-governmental organization was the Alexandria Friends of the Alexandria Library, which was established with the support of University of Alexandria



BA International Friends

staff and officials. Among the founders of the Association was H.E. Ahmad Esmat Abdel Meguid, Egyptian Deputy Prime Minister and Minister of Foreign Affairs; Ahmad Fathy Serour, Minister of Education; Said Abdel Fattah, the University President; Loutfy Dowidar, the Former University President; Mohsen Zahran, the Executive Director of GOAL, in addition to several academic, business and prominent cultural personalities such as Neemat Ahmed Fouad, one of the first donors to the Revival Project. This first Friends Association was registered officially with the Ministry of Social Affairs, as prescribed by Law, No. 989 of 1989.

When the building was finished the Alexandria Friends Association reorganized and the funds became a springboard for the new Egyptian Friends Association, organized by Dr. Adel Abou Zahra. This Association has a broader and more popular basis to serve the Library and the community. It is also officially registered with the Ministry of Social Affairs.

The Australian Friends Association

The Australian Friends Association was founded in 1995, and is still highly motivated by Lorenzo Montesini, originally from Alexandria. They have incessantly promoted the Bibliotheca Alexandrina through their regular cultural programs, and by their constant efforts to reach Australian officials. They have contributed substantially through book donations, aboriginal paintings, and an original musical composition in honor of the Library named “The Beacon” by Aaron McMillan.

The Bulgaria Friends Association

Librarians in Bulgaria gathered together to form an active association in support of the Library. Juja Chakarova, a librarian and founder of the Association visited the Library in 1998 to give a short workshop to the librarians about her experience in working at the Library of Congress. The Bulgarian Friends succeeded in contributing over 1000 items including books and music to the Library’s collections.

The Baltimore Friends Association

Abdel Wahab Elabd, who is also responsible for the Alexandria Luxor Baltimore Twinning City program, established the Baltimore Friends Association in 1998. Members of the Baltimore Twinning City program and of the Baltimore Friends paid a visit to the Library of Alexandria in 2000 and presented a book donation of nearly 100 specially selected books. They also were active in the organization of the fund-raising event that was sponsored by the Egyptian Embassy and the American-Egyptian Chamber of Commerce in Washington DC in April 2000 at the Library of Congress. Mrs. Suzanne

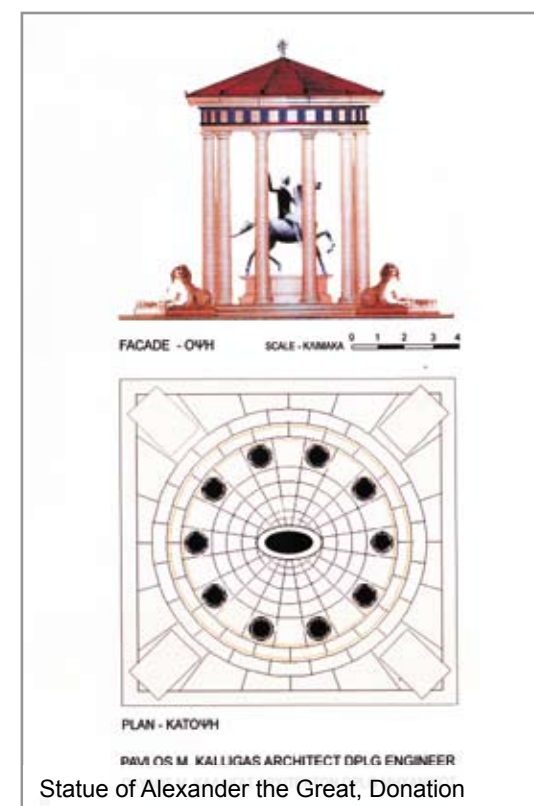

International Friends in Athens



International Book Donations



Greek Support



Showcases Donated by Greek Team



Donation of Australian Aborigines Painting



French UNESCO Delegation

Mubarak addressed the distinguished guests in this memorable occasion that resulted in raising nearly US\$ 850,000. In addition, the Baltimore friends received book donations from various organizations, and individuals from various states undertaking the shipping arrangements to the Alexandria library.

The California Friends Association

The California Friends Association was among the first to be established in the USA. The California Friends is coordinated by a triumvirate lead by Professor Rosalie Amer. Dr. Amer is a dedicated and fascinated supporter who even dedicated her sabbatical to a research project on the Library. She herself donated US\$ 10,000 to the Library in 2000. One of California Friend's first activities was to organize a gala dinner in San Francisco in cooperation with the Egyptian Consul General in 1990 that raised more than US\$ 45,000, which they deposited in the UNESCO special account for the Project use. They continue to raise funds, donate books, and offered some staff training in California.

The Canadian Friends Association

Canada has had several informal groups of Friends over the years. Professor Richard Brown and his colleagues formed a small group that made important contributions to the science collections at the time of the Inauguration. A new effort is presently being made to form an official Friends Association in Ottawa.

The Finnish Friends Association

The Finnish Library Association formed a committee as a Friends Association for the Bibliotheca Alexandrina. They made numerous contributions to the book collections and presented their gifts during the Inauguration to Mrs. Mubarak.

The French Friends Association

The French Friends Association works through the National Commission for UNESCO in Paris. The former President, Jean Sirenelli, and the current President, Bernard Stasi, have been ardent supporters. The Secretary General, Mme. Michelle Deleague, is extremely dedicated and enthusiastic about the Bibliotheca Alexandrina. She has helped in facilitating the contributions and support of various French governmental ministries and institutions. She is still a guardian angel for the staff traveling to France for training at ENSSIB. Mrs. Jacqueline Leroy, was the Resident Librarian at the Bibliotheca Alexandrina for two years and is very active in the French Friends.

The German Friends Association

The German Friends Association, founded in 2000 with the active work of the Egyptian Embassy, has been a great supporter through the contributions of Daimler Chrysler, a founding member. Mr. Joseph Schleicher, Director of External Affairs and Public Policy, the Representative of Daimler Chrysler, succeeded in having Daimler Chrysler support the Bibliotheca Alexandrina by supplying the Young People's Library with books and furnishings, in addition to the two buses, and use of Mercedes limousines for VIPs during the Inauguration ceremonies. Siemens is another founder; it provided computers for an "Internet Café".

A second Friends Association was formed in Frankfurt by Fatma Nokrashy, a former Alexandrian who maintains close ties with family and friends in Alexandria. The Frankfurt Friends have contributed cultural events and book collections to the Library.

The Greek Friends Association

The Hellenic Friends Association have contributed generously to the project. The Greeks have always considered themselves to be at least part owners of the Library because of their historic ties to the ancient Library. We owe a debt of gratitude for their constant enthusiastic support which brought the beautiful display cases in the Antiquities Museum, and for their active involvement to bring financial donations, art works, books and manuscripts to the Library.

The Italian Friends Association

Several informal groups of Friends existed in Italy from the beginning of the Project. Later on, a registered association, Eventi Speciali, became the official association. Federico Wardal, President of the Association has made several important donations of rare manuscripts to the Library, and has succeeded to forge networks and links with Italian institutions.

The Mexican Friends Association

Mexico was enthused by the Project from the very beginning, and a number of important contributions were made, especially the first collection of CDs from the University of Colima. This was unusual at the time, since very few institutions had such capabilities. A formal association was finally formed and is now actively promoting the library, bringing cultural exchanges and promoting the donations of books from Mexican institutions.



Baltimore Friends



International Friends Meeting, Athens



French Friends



President of the French National Library



Norwegian Prime Minister

The Norwegian Friends Association

The selection of the winning design by the Norwegian firm Snøhetta a.s., prompted the active participation of Friends Association created in 1991 with Ms. Bodil Hoem as president. The Norwegian Association was active in persuading strong governmental support for the new Library. The major contribution was the in-kind donation of furniture for the public spaces equivalent in value to nearly US\$ 7 million. In addition, they have collected books for donation to the library, printed specially designed T-shirts to be sold for the raising of funds to increase the Library book collection.

The Spanish Friends Association

The third Association of Friends was established in Madrid in 1991 in cooperation with the Egyptian Cultural Center in Madrid and UNESCO. The Spanish Association was instrumental in contacting various Spanish institutions and universities, which resulted in the contribution of a microfilm copy of the Escorial rare books and manuscripts, on the Arabic intellectual heritage in Andalusia, and a CD on Arabic manuscripts in Cordoba, as well as substantial book donations by the Spanish publishers in fields related to heritage, art, and Mediterranean civilizations.

The Swedish Friends Association

The Swedish Friends, chaired by Prof. Annica Dahlstrom, was established in the late nineties after meeting Mrs. Mubarak during her visit to Sweden. They paid their first visit to Alexandria in January 2000 after several contacts and visits by the Swedish Ambassador to Cairo and a delegation from the Swedish Foreign Ministry who all wanted to discuss the ways and means of the Swedish and Scandinavian support. It was later enlarged to become the Scandinavian Committee (ScanCom) so that Denmark could be included.

They were inspired by the building activities and by the extensive work being done and offered to support a Nobel Section in the Library. It was envisaged that it would include a reference library on all Noble prizewinners in the field of Literature since the Prize was established almost 100 years ago. In addition, a Nobel Seminar room would complement this special library. They promised to raise the needed funds to cover the cost of furniture (replicas to the furniture at the Nobel Institute in Stockholm), as well as photos, books, publications, complementary furnishings, and equipment. They succeeded in raising the funds to furnish the section, now located on the third floor of the Library, with a large meeting room, small auditorium and a foyer with replicas of the furniture found in the Nobel Museum in Stockholm. It was heartening to know that the mission was accomplished and this beautiful facility was completed



Spanish Friends

in time for the Inauguration of the Library in 2002, at the total cost of nearly U\$ 350.000. Later, as promised, another hand-made carpet with special Nordic words of wisdom [text from “Havamal” The High One’s Lay (Thorpe translation)] was presented to the Library for the Gad Rausing Auditorium by the Märta Måås-Fjetterström AB company.

Moreover, members of the Friends in Stockholm, from the Swedish Textile Institute, has commissioned the weaving of a special tapestry using the ancient Pharonic handicraft techniques still used in the Siwa Oasis, west of Alexandria. This was donated to the new Bibliotheca Alexandrina from the University of Boras under the auspices of Queen of Norway during the Inauguration ceremonies. It was jointly financed by the Swedish Institute and the Swedish Foreign Affairs Office. This beautiful carpet is hanging now in the Library Restaurant for all to see and appreciate.

The Danish side, under the auspices of Queen of Denmark, contributed to the cultural programs at the Inauguration, and promising a “Hans Christian Andersen” room for the Library. At present, the Hans Christian Andersen 2005 project is almost completed. It includes the complete works translated from the original Danish to Arabic, along with equipment and other library items. These were formally presented to the Library in late 2005.

The UK Friends Association

The third International Friends Association was established in London, in 1990, in cooperation with the Egyptian Embassy. Mr. Maurice Line, a senior librarian at the British Library, was the first Honorary Secretary of the Association. Members included senior staff from the British Library, as well as prominent academic and cultural personalities and Egyptian businessmen working in London. The Association elected Lord Briggs (also a member of the International Commission) and the Egyptian Ambassador to London as honorary co-Presidents. David Wardrop, Honorary Secretary, has been very active with the International Friends and is now overseeing the Friends project for the new “Peace Library”. The UK Friends prepared a limited edition book on the Arabic texts found in the British Library; *Arabic Treasures of the British Library* to raise funds to contribute the entire Arabic collection on microfilm to the Bibliotheca Alexandrina, which was finally presented during the Inauguration of the Library in 2002.

The Wisconsin Friends Association

In 1990, Mohamed Aman, Dean of the School of Library and Information Sciences at the University of Wisconsin in Milwaukee in the USA, established the second Association at an international level.



Prince Albert of Monaco

Dr. Aman had served as a UNESCO Consultant to the project, was sent as a consultant/expert several times, and was a member of the International Jury for the Architectural Competition. He supported the project especially during the annual meetings of the American Library Association. He gave lectures and wrote several articles in US professional journals. He has also concluded a protocol of cooperation between his University, the French Library Institute (ENSSIB) and the new Alexandria Library for staff training and exchange of expertise, and donated his own personal library to the Library of ISIS (International School of Information Studies), a major component of the project. As a UNESCO consultant he prepared a valuable study on the establishment of ISIS, which he revised and updated more than once.

Meetings of the International Friends

Three meetings for the International Friends were held in cooperation with UNESCO and GOAL, to review the accomplishments of the associations, exchange information, coordinate their activities and create plans for action, to meet the library needs.

The first meeting was held in Athens on 24 May 1996 and hosted by the Hellenic Friends Association under the auspices of the Hellenic National Commission for UNESCO.

The second meeting was held in London on 10 September 1997, hosted by the UK Friends Association and in cooperation with the Egyptian Embassy.

The third meeting was held in Athens again on 15 September 1998. Andreas Zaimas, former Prime Minister of Greece, was the President of the Friends. The Friends agreed at that time to have a symbolic award prepared.

The fourth meeting was held in Alexandria on 23-24 April 2002 as part of the planned Inauguration events. Unfortunately, this Inauguration had to be postponed for reasons outside the Library's control, but the Friends carried on. A fifth meeting was held in October 2002 at the time of the official Inauguration and all the International Friends were invited to come again. Each Friends Association was able to have a representative present their gifts for the Library to Mrs. Mubarak, as Chair of the Board of Trustees.

Other Activities

The Sistership Twining Protocol

The Sistership Twining Protocols were concluded with Baltimore - USA, PACA (Marseilles), France, Solankia - Greece, and Shanghai - China. These protocol cooperation/exchange and joint program for the urban, economic cultural and management fields, are usually the mechanism for further work



Greek Friends

and contacts for active participation, cooperation and involvement in support of the library services, activities, trainings, acquisition and expertise. The Sistership Twining had a great impact on the richness of the library collections, and is currently giving great support to urban projects undertaken by the Bibliotheca Alexandrina in cooperation with the Alexandria Governorate.

Alexandria Festival

Several conferences and festivals were in Alexandria to strengthen cooperation and exchange among more than 40 cities named Alexandria in the Americas, Europe and Asia. These contacts could be further reviewed and energized as mechanism for broader contacts and involvement with public and non-governmental organizations.

Library of Congress

One of the most successful and rewarding meetings held for the Revival of the Ancient Library Project was the dinner at the Library of Congress that was organized by the American Egyptian Chamber of Commerce in cooperation with the Egyptian Embassy in Washington DC. Tickets were sold for this event for \$ 1,000 each, and the evening drew a galaxy of prominent economic, academic and intellectual figures from all over the world. Mrs. Suzanne Mubarak was the guest of honor at this meeting. During the fundraising gala dinner she delivered a speech before a packed audience, which included US and Egyptian business people, academic, intellectual and public figures from all over the world. The dinner raised more than US\$ 850,000. Mrs. Mubarak stressed Egypt's profound interest in spreading reading and culture, mentioning the "reading for all", program as an example. She also indicated that Egypt places a very high value on the renaissance of the Alexandria Library and supported cooperation with the Library of Congress in this regard. She told the audience of 600 that the Bibliotheca Alexandrina is destined to be a center of intellectual ferment. In particular, she stressed the new library's ambition to recreate the spirit of its predecessor, by encouraging lively, and innovative intellectual debate and by serving as a meeting place for different cultures, as well as providing a world-class resource for scholars and academics. She said:

"I have seen the production of children's literature as part of our Reading for All program evolve over the years and it has succeeded in encouraging a large number of readers to use the wide spread network of libraries established during the last decade. Today the setting and the topic I have come to present have been so well matched, for we stand here within the famous Library of Congress, the world's greatest library, to discuss the revival of the ancient library of Alexandria. With its some 120 million

books and artifacts, its enormous research facilities, and its outreach programs, the Library of Alexandria encapsulates the grandeur of the world of antiquity. The Bibliotheca Alexandrina is an inspiration from the past, as it was known in the ancient times, was both an Egyptian and an international enterprise, conceived at the beginning of the third millennium.”

“Today we embark on an ambitious venture to revive the ancient library on its original site and to help it attain a new grandeur in this new millennium. Our dream is for the new Bibliotheca Alexandrina to embody the spirit of the ancient library and become a center of scholarship and learning and of dialogue, tolerance and understanding between our region and the other nations and peoples of the world.”







“The dissemination of knowledge is one of the cornerstones of civilization.”

John F. Budd

CHAPTER 10

THE INTELLECTUAL CONTENT
AND DEVELOPMENT OF
HUMAN RESOURCES



Interior of Library

The New Library of Alexandria is no illusion and certainly not just a meeting center. It is an intelligent building that is even brighter from the inside through its intellectual content than from the outside, which is a world wonder.

The mission of the Bibliotheca Alexandrina is based on the pursuit of excellence of human knowledge and the advancement of research for the benefit of Egypt, the region and mankind everywhere. This is being implemented through the book collections and dissemination of information and knowledge, in addition to its obligation for the preservation of the intellectual heritage of Egypt, the region and beyond.

The revived Bibliotheca Alexandrina, welcomes with open arms the new millennium with its technological developments and eradication of the digital divide. The third millennium is the technotronic age, and the enormous digital intellectual resources should be made available to receive the fruitful

achievements of the past, and launch into the future with assured steps, in to the wide horizon of information technology. For many years, networks around the globe assisted all librarians to give the end user, worldwide access to all kinds of information.

Antiquities are the collected memories of the past, which will be taken along with us into the future. As President Hosni Mubarak once declared “Egypt is endeavoring to revive one of the most magnificent monuments and greatest symbols of its civilization. We hope it will contain all documents and publications, both ancient and modern, relating to Egypt and the Mediterranean basin.” The Bibliotheca Alexandrina will not be an object of elite prestige, but will also be a center of excellence, a collection node of heritage, whether of Hellenistic antiquity, the Middle East, the marriage of Greek and Egyptian civilizations, the birth of Coptic Christianity and the influence of Islam, up to modern times. As it was always asserted since the early 1990s, it will become the window of Egypt on the world and the window of the world on Egypt, a forum for dialogue, cooperation, inspiration and manifestation.

Besides, the ceaseless development of the globalization of the electronic technology for digital resources, paper copies and films, are still essential for the development of the resources, besides the collection of rare manuscripts in Egypt held by the Egyptian Islamic mosques, Coptic museums, and libraries. We will collect all these original valuable documents and preserve them for further digitization.

The role of the Library of Alexandria is unique, and its characteristics will be as follows:

1. The Library will play a pioneering role as a bridge between the North and the South, East and West. The entire collection, whether cultural, scientific, or historical, will cover the most specialized areas. From the beginning, the UNESCO experts and others recommended specialized collections, in depth, to cover:
 - a. The Pharaonic Period.
 - b. Ancient Greek and Hellenistic civilization
 - c. Heritage of the Arab–Islamic civilization
 - d. Modern civilization.

Of course, this has been refined over the years and now more serious efforts are being applied to give breadth and depth to the specialized collections. The Bibliotheca Alexandrina does not want to duplicate collections found at other libraries, however it will not become a centralized resource according to its specified goals.

2. The Library will be the interface between the new technologically developed information and the old archived collections.
3. The Library will be the interface, the electronic extension of the 21st century, for a global cultural development. This electronic extension will achieve the beginning of a global communication.

The Library is also an international arena for cultural activities and cooperation to serve all people, no matter what their creed, color, or origin might be. The New Library, like its ancient predecessor, is an open forum for debate, for all individuals, with conflicting points of view, to discuss and interchange ideas. We would thus be able to learn from others and exchange collections of the past as memories to be kept and treasured in our present existence and become a valuable intellectual resource to nurture our minds and souls.

The collection system was innovated back in the ancient ages, when Ptolemy created two ways to collect all the published books in the world: 1. by sending a letter to all the powerful people of the world asking for one copy of each book they possess, and 2. the confiscation of all books on ships passing through Alexandria to make copies of them for the Library (or keeping them, as some historians report).

In summation, one can focus upon the following:

1. The Bibliotheca Alexandrina will be responsive to the present and future needs of scholars and researchers. We should encourage potential users and researchers to get their information and materials within the Library and build the Library collections according to the specialized topics already mentioned.

This is a process that has been going on since the beginning of the Project and will not be accomplished over the short term.

2. The Bibliotheca Alexandrina continues to establish cooperative programs, protocols, and agreements with research libraries and institutions throughout the world, especially within the Arab, African and Mediterranean circles.



Baltimore Friends

This has been going on since the first UNESCO “Appeal” to the world community to support the Library.

3. The will for collection and preservation is dramatically strong. We should devote a large budget for the collection development, digital and otherwise, in addition to the legal deposit stature of publications from Egyptian book production, and other willing publishers.
4. The preservation of cultural heritage should be through the new electronic media capabilities. This, in fact, began well before the inauguration of the Library, when the first information technology was acquired through a UNESCO administered grant that allowed microfilms of rare manuscripts to be restored and converted to a digital format.
5. The “Museion” was, in the ancient Library, the meeting place, where all the scholars, thinkers, and historians among others, met to debate and exchange ideas. A new form of the Museion is already within the Library through its specialized Centers and the academic/cultural programming.
6. The Bibliotheca Alexandrina is a lighthouse of knowledge, the fourth pyramid of Egypt, and the eighth wonder of the world, as it was described in the national and international media since its completion. Thus, its activities, operations and impact should correspond with this image and stature.
7. The Bibliotheca Alexandrina is a public research library, serving not only the region, but the entire world, the window of Egypt on the world, and as the First Lady Mrs. Suzanne Mubarak once declared, the world’s window on Egypt. Based on this, the Library does not and will not exist in isolation, nor should the Library be established and developed without full recognition of the role played by other international libraries and institutions.

In response to the UNESCO “Appeal” many libraries worldwide have already collaborated in supporting the Bibliotheca Alexandrina’s role and objectives to become a regional node in the global information network.

The world of information is indeed a dynamic one and every day brings a new opportunity, a new development, and a new dimension to preserve the entire intellectual output for human heritage. Based on this belief and motivated by this spirit, the role of every member of the staff working at the Bibliotheca Alexandrina, whether a head of a department, or an average staff member should achieve a



Omani Book Donations

difference, a change, a reform if not daily, periodically. He or she should work with others to overcome the information and digital divide, to eliminate the borders and divisions of time, place, and space, the discrimination of human societies because of color, creed, origin, sex, language or belief. The motto of the Library should be “All for one , one for all”.

The concept of the Bibliotheca Alexandrina was always to join the present with a determined reach onto the future in multiple dimensions, and will open its doors worldwide for the development of progressive societies, enlightened citizens, researchers and scholars from Egypt and from all over the world. The Bibliotheca Alexandrina will be an active, dynamic organization capable of ensuring the satisfaction and fulfillment of the national cultural, scientific and social needs.

Training of Human Resources

Since 1989 an extensive program for recruitment and training of Human Resources was undertaken to proceed, in synchronization with the construction activities and collection development plan. The goal was to start the execution of the building and to recruit the best staff in the meantime. To achieve this challenging mission, specific activities were carried out. It was significant that UNESCO supported the collection and Human Resources development feasibility study back in 1987/1988. Upon the recommendation of the first IEC meeting in April 1992, a special committee was created to address specifically the intellectual content of the Library. The Committee held several meetings in Alexandria and Paris, and submitted their meaningful recommendations in 1993.

Recruitment of the Library staff began in 1989, after the enactment of the Presidential Decree 523/1988 creating GOAL (General Organization for the Alexandria Library). Qualified young staff , new graduates were employed in the Library services, engineering, administration and finance departments according to actual work plan needs and the tools available. The staff increased gradually to about 250 by the year 2000, which included about 120 librarians. In the meantime, the administrative financial and technical bylaws for GOAL were adopted according to governmental civil service laws and regulations.

The ES and GOAL worked closely to ensure that nearly 50% of the Library technical staff received appropriate short and medium term training scholarships offered by UNESCO, France, Italy, United Kingdom, Germany, Spain, USA and Canada. Valuable practical and academic experience and transfer of knowledge were gained from these visitships and internships, academic courses and on the job training in the fields of information, library sciences, library services, multimedia libraries, information technology,



Euro-Med Meeting in Naples



Information System by France

and book restoration and conservation. Those who received such valuable training in international institutions and libraries became trainers for the newly appointed staff. Those who did not have training abroad were recipients of in-house training by Egyptian and foreign experts and consultants. They are the driving forces that are now manning the Library activities.

Regular foreign language programs and protocols were implemented in cooperation with the French, Italian, Spanish, and German Cultural centers in Alexandria to enable the Library Staff to acquire valuable working knowledge of foreign languages to help them in performing their technical tasks and services to the users.

With UNESCO/UNDP, the Arab League, the Italian, German and British short term consultancies support expert missions from abroad were carried out since 1988 to advise on various technical requirement to the library staff and to help in planning for the activities, services and facilities of the new Library.

More than thirty academic staff members from Egyptian universities were called upon as consultants in various fields of the library construction, engineering, library functions and services, informatics, conservation and information technology.

I wish to recognize here with deep appreciation the dedication, commitment and professionalism of Mostafa Hossam Eldin, Professor of Library Sciences at the University of Cairo, Faculty of Arts, who gave with admirable commitment and professionalism his time, efforts and support for valuable training to the Library staff on technical aspects of the Library functional planning and development, for more than five years during his weekly program.

Through the financial support of the Italian Government, executed through UNESCO, academic practical training of the Conservation and Restoration Laboratory staff was provided in Florence at the Istituto per l'arte e il Restauro, Palazzo Spinelli, as well as short-term consultancies in rare manuscripts restoration and conservation in the conservation Laboratory. Based on this valuable contribution and support, needed conservation work of the valuable heritage of rare manuscripts was carried out from the Municipality Library, the Abou El Abbas Mosque Library, and El Azhar Institute Library at Semouha, which were added to the Library's collections. In addition, different departments of the Library began the development of databases for the main fields covered by their collections. The Italian FIT Project also provided conservation, restoration and digitization equipment for the temporary Conservation

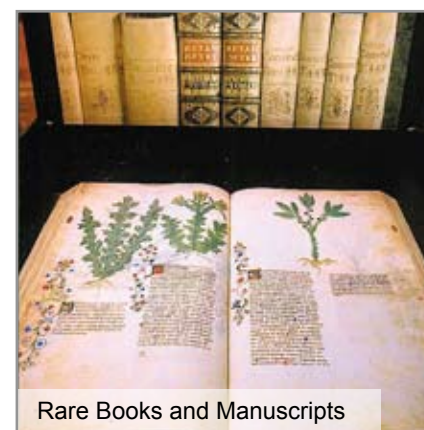

Rare Books and Manuscripts

Laboratory at the Shallalat ES/GOAL Headquarters before moving to the new Bibliotheca Alexandrina building at Selsela.

Library Information Systems

UNDP/UNESCO provided a US\$ 1.2 million financial grant under the Project EGY/88/003 which supported the computerization and automation of the Library in the original offices at Shallalat and developed the LAN and other software facilities. It also provided equipment for the digitization of the Library's valuable manuscripts and conservation facilities. It helped not only in training scholarships and providing international consultants, but also the internet and memory of the Library digital documentation.

The support of the French government in the development of the information system by Cap Gemini was important, through a FF 4.4 million grant that was later on implemented through a FF 38.5 million long-term loan by EI Audiovisual (EI). Mrs. Jacqueline Leroy and Mr. Gerald Grunberg, French in-house advisors, were instrumental in the conceptualization, negotiations, pursuit and conclusions of those important agreements. It is important to commend the efforts and professionalism of Dr. Ahmed Darwish, Professor of Computer Sciences at the University of Cairo, who was also the ROSTAS/UNESCO Cairo Office computer consultant. He helped with the negotiations for two years, to reach the best terms and specifications for the Library Information System. His work and views were highly appreciated by all. Dr. Darwish is currently the Egyptian Minister for Human Resources Development.

One is also grateful for the great contributions of software and hardware by American companies such as VTLS (2001) and Oracle (2000) (equivalent to several million US dollars) which helped in the automation and digitization of the Library according to international standards, operations and performance.

The Library

The Library is not a simple repository for books, but also a unique lighthouse for cultural stimulation. However, we cannot attempt to acquire comprehensively the literature of the world, and it varies in scope and size from the smallest libraries (such as the National Library in Bern) to one of the largest (such as the Library of Congress). Between those two extremes all possible variations are to be found. National Libraries collect more in the humanities and the social sciences such as literature, arts, music, etc. and vary in science and technology, medicine and engineering, in addition to a reference collection including

bibliographies, library catalogues, indexing and abstracting services, to be able to assist researchers to conduct their research Projects, whether available in the country or from abroad.

The Library is changing with time and with the new technologies that have become available. For example, we now have a “Multimedia Library” instead of a music library. Instead of a few computers with the capability of enlarged print, we now have the Taha Hussein Library for the Blind and Visually Impaired, and are now planning how to reach out to other disabled users. As time changes, so will be the form, content, functions, activities and means to respond to changing requirements, demands and aspirations.

Young People’s and Children’s Libraries

“The foundation of every state is the education of its youth.”

Dionysius

As technology changed and developed, the Library had to adapt to the new conditions. This took place towards the end of the construction period, when all realized that young children would be better able to cope with future technology if they began learning as early as possible. This promoted the development of the Children’s Library and it has become a popular place for parents to bring their children, to learn and experience without the pressure of obligatory homework from school.

We owe our young generation full support and care for a bright future. Young people were always considered in the planning of the Library and as such, the Bibliotheca Alexandrina promoted this concept from the beginning by including a place for the Young People’s Library. In addition, Mrs. Mubarak has persistently underscored the need for reading in her ongoing work for children and the family. She began the “Reading for All” campaign in 1995, and later initiated a program “Read for Your Child” to encourage parents to take an active part in the promotion of greater interest in reading with their children.

The Young People’s Library and the Children’s Library are sections of the main library. The staff are especially trained to deal with those age groups. The young people and children have a variety of books and a suitable workplace for their age. The objective is to familiarize young people with the Library, the techniques and tools for research and study, and with the information and communication technology that is now available to them.

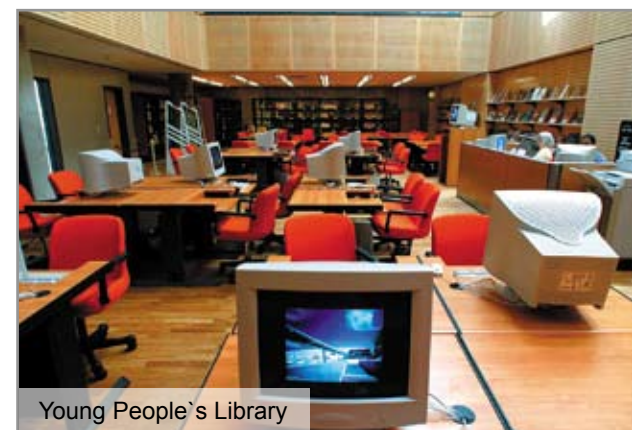

Young People’s Library

Academic and Cultural Activities

The activities and programs of the Library are assigned to a number of departments and centers such as the main library and the Academic and Cultural Sector Centers. These centers existed in principal, e.g. the Calligraphy Center and ISIS, and were officially added to the Bibliotheca Alexandrina by Presidential Decree No. 76. Originally, the International School for Information Studies (ISIS) was the centerpiece of these activities, but an ambitious plan was developed as the construction came to a close. This was the formation of a number of independent centers that would function together much like the ancient Museion, by providing stimulating programs, research and outreach to the public and the world.

International School for Information Studies (ISIS)

ISIS has always been a central point in the planning for the Library. It was originally planned to be an institute for training librarians to use the new developing technologies to become an outstanding staff at the new center of excellence. Dr. Mohamed Aman, former Dean of the School of Library and Information Studies at the University of Wisconsin (Madison) proposed the curriculum during his several consultancies to the Project, and donated his own personal library for this purpose. However, as the Project progressed and the Library neared completion, the new technology evolved at a faster pace than was ever imagined. It became obvious that the program needed to be reviewed and updated. Since then ISIS has developed into an outstanding center for research and cooperation for the new communication and information technologies.

The Planetarium and Science Center

The Planetarium is a tribute to the outstanding astronomers and scientists who worked and studied at the Museion and the Ancient Library. The entrance to the Planetarium is accessible from the Plaza of Civilizations, and from the Conference Center through the underground passage, or from the Library's underground passage. It is linked electronically to the whole building complex through the Library Information System. Both are located outside the main building to maintain their independent program scheduling.

The eighteen meter sphere of the Planetarium is an outstanding landmark beside the Library. It is a hovering planet at night with orbiting circles of blue light. Both can be seen from each end of the Corniche. It is housed in a sphere-like structure, supported at the lower hemisphere by two free bridges, and partially lowered into a deep-set reversed pyramid whose glazed surface forms the Science Museum.

The Planetarium sphere is clad with fiberglass cemented curvilinear panels arranged in strips encircling the sphere, with a white stripe in bluish circles rotating around it blending harmoniously and serenely with the night sky. It is a masterpiece, by itself, although strongly related to the Library building.



Planetarium and Olive Trees

The unique roof of the Library symbolizes the modern microchip making it a connection between nature and science. The contrast between the roughness of the exterior stone wall, the smoothness of the roof, and the Planetarium sphere complement each other and harmonically blends the two structures into a piece of art. The Library and the Planetarium present a new scientific outlook, between the future and the past.

The History of Science Museum is one of the most significant public facilities at the New Bibliotheca Alexandrina. The History of Science Museum and the new Exploratorium are a pedagogic tool to promote basic ideas about the earth and sky.

The History of Science Museum is located below the Planetarium sphere. It covers the history of science during the Hellenic/Roman period in which the mission and discoveries by the scholars of the ancient Library are displayed, the Renaissance, and Islamic times. The space located below and around the planetarium globe is an area of nearly 400 square meters, it includes displays on geography, history, astronomy, medicine, and mechanics. The French Government has undertaken the design of the displays for the Museum. The Project staff and Egyptian experts worked closely with curators and designers from the Musée d'Arts et Métiers in Paris to develop the objectives and content of the Museum.

The new Exploratorium, about 1600 meters, was not in the original plans of the Library, but was developed during the construction work. The space was originally planned as part of the subterranean garage, but it quickly became evident that science and its immense influence on all our lives needed a greater presence within the facilities. The Project engineering staff worked with the Project staff on the initial planning for the Exploratorium. They reviewed the work at other Science Museums, studied catalogs, and planned initial purchases through funds remaining in UNESCO grants. The initial planning and work has now come to fruition in a popular and well-used facility that brings science to life for young people, and encourages their further interest and study. It has various displays, with a hands-on approach for people, especially children, to have a direct involvement in the display. It is accessible and open to the public even at times when the Library is closed.

The Calligraphy Center

The Calligraphy Museum was originally planned to be in the area next to the Antiquities Museum, actually a passageway between the Library and the Planetarium/Science Museum. Environmental conditions in this area are very good for art works, however it lacks the easy accessibility necessary for public viewing. The Library has changed as it has grown and matured, and no doubt it will soon be able to find a permanent home for these special and valuable pieces.

The Center holds a unique collection from the famous Alexandria Calligraphers Mohamed and Kamel Ibrahim, consisting of famous Arabic scripts, using different materials, and calligraphic exhibits on the loan from the family of the late Mohamed Ibrahim, the founder of Alexandria Arabic Calligraphy School. Additional examples of calligraphy are found in the Manuscript Museum, which includes two pieces of the black silk drapery from the Holy Kaaba in Mecca.

This Center also records, documents and conducts research on calligraphy, not only in Egypt and the Arab world, but throughout the world. It also stimulates interest in calligraphy for the public through its outreach programs.

The Antiquities Museum

The Antiquities Museum was always a part of the design program since the beginning of the Architectural Competition, since there were always strong suspicions (now proven true) that there would be important artifacts found at the Library building site. The High Council of Antiquities approved the display of the archeological items discovered at the site long before construction at the museum. Additional artifacts from the Greco-Roman museum and other stores of antiquities were selected by the Antiquities authorities for display in the new Museum while the building construction was going on. A Committee that oversaw the whole Project drew up the objectives and plan for the Museum. The new Museum would represent all the stages of Egyptian civilization, including Pharaonic Egypt, the Hellenistic period, Coptic and Islamic Egypt, up to modern times. We worked together closely with the Antiquities Authorities and this resulted in an excellent broad overview of Egyptian history that touched on every facet of public and private life in those periods. The Bibliotheca Alexandrina is fortunate to be able to even display mummies and their splendid coffins.

This display eventually included items found by the new surveys and underwater exploration in the Eastern Harbor that began in 1996. The statue of Ptolemy I Soter, once thought to have stood at the entrance to the Pharos lighthouse, is now proudly displayed at the entrance to the Plaza. Other artifacts, busts, and statues, such as the stunning statue of Isis in black basalt, found underwater is displayed in the Museum.

Thanks to the generous Greek donation of the state-of-the-art museum showcases, which provide adequate security and safety for the artifacts, the Antiquities authorities have not only agreed to the display of the items, it has also assigned a special staff for the Museum. The staff of the Museum are not only experts in archaeology, but provide important information to visitors.

The Manuscript Museum and Manuscript Center

The Manuscript Museum houses some of the special collections of rare manuscripts at the Library. There are about 10,000 manuscripts currently in the collection, not including the special digital and microfilm/microform archives from Spain and other sources. The Library specifications indicated that the special conditions necessary for safeguarding heritage, such as rare manuscripts, would be present. In addition, the Conservation and Restoration Laboratory would be of added benefit towards the goals of preservation. The new facility and the showcases in the Museum follow international standards for the safeguarding of such heritage, and thus has become a depository for the collections from the Alexandria Municipal Library, Al Azhar Library (Alexandria), and the libraries of important mosques in the city. Among the important exhibits are pieces from the Holy Kaaba with quotations from the Holy Quran embroidered in gold donated by Mohamed Ibrahim, as well as another black silk drapery of the Kaaba donated by Crown Prince Abdallah Al Seoud, presently King of Saudi Arabia.

The Manuscript Center evolved from the work of the Library staff and experts that began working on the manuscript collection during the construction phase. Links were established with other Arab countries to preserve their manuscript heritage through digitization, and at the same time acquire copies for the Bibliotheca Alexandrina collections. The Center intertwined with the preservation of heritage and linked to the Conservation and Restoration Laboratory, as well as to many Projects for the digitization of rare manuscripts and for the dissemination of the knowledge they contain. The Project began this work with its first publications since 1996, indexing the manuscripts found in the various libraries in Alexandria, and especially the municipality library.

Center for Scientific Studies and Programs (CSSP)

This Center is certainly an important manifestation of the heritage of the Ancient Library. All the eleven generations of the Ptolomies reached out to scientists from Greece and other nations to attract them to Alexandria and provided them with support to further their research and studies. This work did not stop when the Roman Empire was extended to include Alexandria and Egypt, because prominent scientists worked in the city until the mid-fourth century CE. In keeping with this tradition and heritage, the CSSP is intended to reach out to young scientists and is creating networks of scientists, thereby bringing the newest discoveries and technologies to Egypt.

The Arts Center

The Arts Center was not originally planned at the design and Construction phases. However, cultural programming was always in mind because of the facilities that the Conference Center provided. During the Project, and for some time after, the Cairo Opera House held international and national performances there, since it was the best venue in Alexandria.

Towards the end of the construction period, several important changes were implemented in the Library, as well as the Conference Center. These were the development of world-class exhibition areas in both facilities. The north and south exhibition halls were added to the Conference Center, and the special exhibition spaces were added to the Library building, especially in the B1 area and next to the Planetarium. Now, exhibitions at the Library come from Egypt and from abroad, in addition to exhibitions organized by the Arts Center and the Library itself to illustrate the literature, collection of art, rare manuscripts, and other holdings in the Library.

Permanent Exhibitions

There were originally two permanent exhibitions within the Library and they have now reached nine. These collections and the displays were not originally part of the plans for the building. However, several initial contacts were made with their owners during the latter part of the construction period and these contacts set the stage for the future exhibitions. It should also be noted that the Preparatory Committee took note of Alexandria's history in early cinematography and gave strong recommendations to include this history within the Library's collections in the best way possible. These exhibits also follow the earliest guidelines for focusing the Library's collections on Alexandrian and Egyptian history.

Alexandria-Mediterranean Research Center (Alex-Med)

The Alex-Med Center was not part of the original planning of the Library. However, I would like to point out that the symbolic significance of the Bibliotheca Alexandrina facing the Mediterranean indicated from the beginning that the Library was reaching out to its neighbors, and would always be ready to generate and sustain contacts, cooperation and research programs.

The Center documents and researches tangible and intangible heritage of Alexandria and the Mediterranean and relates it to the sustainable development of the city. It encourages mutual understanding and sharing experiences related to issues of common interest in the Mediterranean Basin.

Center for the Documentation of Cultural and Natural Heritage

The Center for Documentation of Cultural and Natural Heritage is currently situated in Cairo to which the Library is linked electronically; it is also affiliated to the Ministry of Communication and Information Technology. The Center aims at using the latest technological innovations to document Egypt's cultural heritage with both its aspects: tangible and intangible, as well as Egypt's natural heritage which includes information about the natural areas and their biological components. The implementation of the Center's work plan is carried out in collaboration with several national and international organizations. Introducing Egypt's heritage through the media and electronic publication leading to building public awareness and training of professionals in the field of heritage are among the Center's main objectives.

Institutes Hosted by the BA

The New Library of Alexandria also hosts a number of institutions:

The Academia Bibliotheca Alexandrinae (ABA), the Arabic Society for Ethics in Science & Technology (ASEST), the Anna Lindh Foundation for Dialogue between Cultures, the first Euro–Med foundation based outside Europe, the Institute for Peace Studies of the Suzanne Mubarak Women for Peace Movement, the HCM Medical Research project (located in Shallalat premises), the Jean-Rene Dupuy Center for Law and Development, the Arab Regional Office of the Academy of Science for the Developing World (ARO-TWAS), the International Federation for Library Associations (IFLA) Regional Office, the Secretariat of the Arab National Commissions of UNESCO, the Middle Eastern and North African Network for Environmental Economics (MENANEE).

It also hosts the Peace Studies Institute which was launched by the Suzanne Mubarak Women's International Peace Movement and the Bibliotheca Alexandrina on 15 and 16 February 2006. The Institute will focus on research and training, preparing material and case studies, promote the culture of peace, enhance human security and expand the role of women and young people in the process of peace building. The Institute is in pursuit of forming new partnerships, on the regional and international levels. The first of which is the collaboration with The University for Peace in Costa Rica.





“ They are never alone that are accompanied with noble thoughts.”

Sir Philip Sydney

CHAPTER 11

FUTURE OUTLOOK: PROMISES
AND HORIZONS



Hall of Fame

The future of the New Bibliotheca Alexandrina depends on how far it becomes like its renowned predecessor; a beacon of knowledge, through the dedication, support, and resources we devote to this new creation, until it matures and bears the fruits of goodness, advancement, and progress. Today, mankind has inherited a wealth of knowledge, given without restriction or bias, by our great grandfathers; the scholars of the ancient library. Such was the ingenuity of this knowledge which has become the basis of today's world civilization. Similarly, we owe the coming generations and those who are yet to be born in the coming millenniums, a new legacy of intellectual research and breakthroughs in human knowledge upon which they can build their own civilization and future. This was the message and mission of the ancient library, which must be preserved.

The Revival of the Bibliotheca Alexandrina is already having a profound influence on Alexandria, Egypt, the region, and the world. The city of Alexandria is already undergoing a comprehensive urban development and face-lifting, physically, socially, economically, and culturally. A spirit of pride, honor,

and hope for a better future has ignited Alexandrians' imagination and motivated their commitment and loyalty to the Project.

Within one month of the experimental opening in October 2001, nearly 200,000 visitors and users came to the new Library to admire its cultural activities and benefit from its facilities. We know that since that time, and after the Inauguration, there are around 2000 visitors per day at the Library. From Alexandria University alone, more than 10,000 post-graduate students and 7000 academic staff waited for the Library to use its intellectual resources and cultural facilities through protocols of cooperation, training and exchange that the Library has signed with international and regional organizations. The intellectual and scholarly mutual benefits and rewards will be available for the masses. Agreements were signed throughout the Project lifetime with UNESCO, the Library of Congress, the National Library of France, the French Library Institute of Library Science (ENSSIB, Lyon), the Limoge Public Library, the School of Library and Information Sciences (University of Wisconsin), the Quebec National Library, the Vatican Library, the Shanghai Public Library, and other institutions, in Alexandria, Cairo and worldwide.

Mrs. Suzanne Mubarak, Chair of the International Commission, and now Chair of the Board of Trustees, began outlining her hopes and expectations of the New Library well before the Inauguration in 2002. These culminated in her succinct vision for the Library, which she announced in May 2001 in which she declared that the Library would focus on four main aspects. The Library would be:

1. The world's window on Egypt,
2. Egypt's window on the world,
3. A Library for the digital age, and
4. A center of learning and dialogue.



Library Overlooking the sea

These are some of the promises:

- It is expected that the New Library architecture will spark new directions and schools of thought in architectural philosophy and conceptualization. The building has already been labeled as one of the eight architectural wonders of the new millennium. One would expect that this new lighthouse would generate, nurture and catapult new directions, visions and schools of thought, innovations and breakthroughs in many fields, regions and directions. Already reflections and imitations can be seen in Beirut, Jeddah, Kuwait, Qatar, Bahrain, UAE, and Turkey.
- The creation of the Plaza of Civilizations within the Library complex is a new complement to the urban fabric and cultural environment in Alexandria, as well as a unique example of urban environmental harmony which will have a radical impact not only on its direct vicinity but the whole city. An open public cultural plaza is a new innovation in urban design in Egypt and the Middle East in general, where squares and plazas are primarily road traffic intersections. This new example will alter current urban planning and urban design practice in the region. Echoes can be seen in Dubai, Kuwait and Beirut.
- The New Library, as the first intelligent building in Egypt and the region, will become a pioneering model for other institutions in the region, where major socio-economic, cultural and technological changes are undergone to cope with the digital divide, the compelling needs of globalization, socio-economic and the technological developments, especially that most countries now have become committed to the new rules and obligations of the international community to institute social, cultural and political changes as well as needed reforms in all fronts
- The tragic events of 11 September 2001 have raised and intensified fears from the clash of civilizations and the possible consequences of their confrontation. Some circles even spoke of a “new crusade” bringing back the images of horror, war, and regression. The New Bibliotheca Alexandrina, as Mrs. Mubarak outlined in her address, is a forum for meeting and cooperating, for union and fusion, not division and fission, of scholars from all regions; a haven for dialogue between civilizations, rapprochement, interchange, and the union of human aspirations. Diversity of cultures and difference of civilizations can be well invested for the good of all to bridge gaps, build bridges, and share experiences for a better future. The New Library has already ignited this communication between Arab countries, and between the North and South, the East and West, as well as in the Mediterranean circle.

- The various intellectual and cultural institutions of the New Bibliotheca Alexandrina make it possible to have an annual agenda of events, exhibitions, conferences and symposia where the intellectuals and scientists at the highest levels participate.
- There is hope to have a Bibliotheca Alexandrina Prize, and in fact, several prizes have already been awarded through the different centers.
- Plans are also underway for the support of distinguished scholars, as well as for young scientists, in cooperation with international institutions.

The Bibliotheca Alexandrina and the Digital Divide

The information technology revolution has made available, and mandatory, accessibility to information using the Internet's fantastic resources and possibilities for the entire world, regardless of time, place or culture.

The Bibliotheca Alexandrina, of course, is and will be interactive and conversant with the universal digital networks. However, the digital divide is widening between those who know, and those who do not. Computer and digital illiteracy is omnipresent in the developing world, and the gap separating it from the developed north is getting deeper and wider than ever before. Out of nearly 30 million World Wide Web domains, 41% were in the USA and Canada, 27% in Europe, 20% in Asia (including Russia, China, India, Japan and Australia) and the remainder in Latin America (4%), the Middle East and Africa. Moreover, out of 600 million worldwide Internet users 50% are in North America alone.

The Bibliotheca Alexandrina will certainly address this inaccessibility to knowledge and hindrance to a sound human development for all communities, especially for researchers.

The Hall of Fame

"It is the mind that makes the man, and our vigor is our immortal soul." Ovid

This memorial space was thought of from the very beginning as one of the key nodes and meaningful reference elements of the architectural brief which I was entrusted to propose by the Preparatory Committee of the project in 1985. It was specifically referred to in Article 3/10 of Presidential Decree 523/1988 establishing GOAL. I have charged an Armenian research assistant in 1996 to prepare a thorough study of the space, the famous founders and scholars of the ancient library, as well as their notable achievements. Sonia Manoukian, a volunteer from the USA, spent almost one year to develop an important proposal on the design plans and scenarios of this space of fame, depicting indelible

memories of those luminary figures of the ancient Alexandria Library. The men and women of fame included:

- Alexander the Great
- Aristotle
- Ptolemy I Soter
- Ptolemy II Philadelphus
- Ptolemy III Euergetes
- Demetrius of Phaleron
- Callimachus of Cyrene
- Alexander of Aetolia
- Lycophron of Chalcis
- Apollonius of Rhodes
- Zenodotus of Ephesus
- Aristarchus of Samothrace
- Herophilus of Chalcedon
- Cleopatra VII
- Archimedes
- Julius Casear
- Mark Antony
- Eratosthenes of Cyrene
- Aristophanes of Byzantium
- Theocritus of Syracuse
- Euclid
- Hypatia



Hypatia



Cleopatra



Euclid



Eratosthenes



Demetrius



Aristarchus



Demetrius

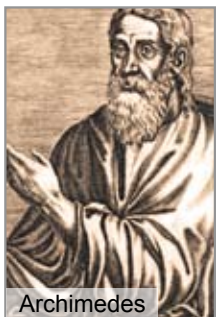

Archimedes

It was difficult to acquire statues of those historical personalities, but it was possible to order copies of original sculptures to the various museums in Egypt, especially the Greco-Roman Museum, from the British Museum in London, or national museums in Athens or elsewhere from museums in Paris, Rome, Vienna, Berlin, New York or Chicago.

The Hall of Fame should be a memorable and meaningful forum where the sounds and sights of history resonate and radiate; a reminder of the ancient Library's illumination and radiance of achievements in pursuit of knowledge and advancement of human civilizations.

Perhaps the Hall of Fame will charge and spark the imagination and ingenuity of young scholars of today and tomorrow to match, or even surpass, the achievements of their forefathers at the Hall of Fame, hoping that they too may join them one day as well in the rotunda of the famous.

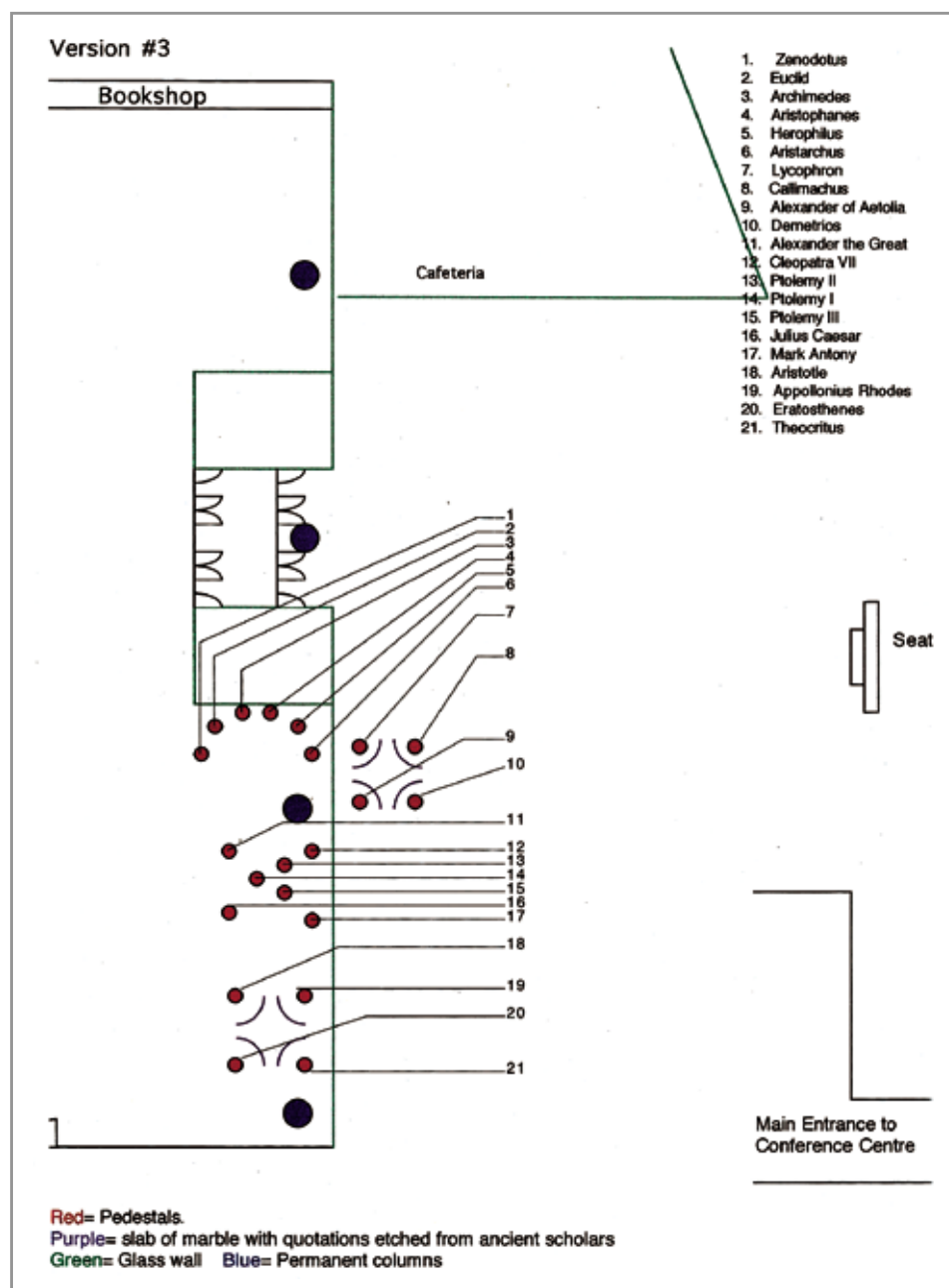



"Only those who risk going too far can find how far they can go."

T.S. Eliot

CHAPTER 12

REMINISCENCES; THE HUMAN
DIMENSIONS: FLASHES OF
INDELIBLE MEMORIES



Interior of Library

During the implementation of the Project, the lonely, consuming years of rise and fall, laughter and tears, advances and setbacks, hard times and great moments, agonies and ecstasies, I was lucky to meet a multitude of leaders and citizens, adults and children, men and women from all nations who came to support the Bibliotheca Alexandrina. I have also met and seen people who strove to bring the Project to a halt. I watched, marveled and learned enormously about human charity, human vanity, and human devotion. Human frailties were abundant, though human goodness was boundless.

Success has many fathers and failure is an orphan. After the completion of the Project, many people including those who previously shunned the undertaking, falsely claimed to be the godfathers of such a marvel. One even attempted in an interview to marginalize my role, claiming that I was only responsible for the building and construction part of the Project despite the fact that regardless of all the obstacles thwarting the realization of the Project, I was responsible for all the aspects of the rebuilding process, container, content, finance, management, human resources development, book collection building, public relations, fund-raising, promotion, and even logistics.

In this chapter, I reflect upon my own personal experience with the Project and I attempt to pay tribute to those who contributed to it and helped in its ultimate realization.

Dr. Fareed Mostafa

Real credit and ultimate recognition is due to Dr. Fareed Mostafa, University President from 1984 to 1987. He established and chaired the Preparatory Committee for the Library, and passed decrees allocating the present Library site and Conference Center to the Project. He truly propelled the Project into an accelerating orbit, yet chose to shun limelight and distance himself from publicity and fanfare. He is the true “godfather” of the Library.

President Hosni Mubarak and Mrs. Suzanne Mubarak

I cannot forget President Mubarak’s personal encouragement after showing him my preliminary design proposal at the Conference Center before laying the cornerstone at the site on 26 June 1988; and Mrs. Mubarak’s unflinching support since then. President Mubarak met annually with students at the Conference Center every Summer, since 1992. His personal support, declarations and contacts during the Aswan International Meeting procured substantial donations of Arab leaders worth \$65 million. Mrs. Mubarak made contacts as well, and five million dollars were soon appropriated to help with the execution and the establishment of the Executive Secretariat (ES) in the ES/GOAL temporary headquarters in Shallalat.

UNESCO

UNESCO’s support was crucial for the Project’s success. The visit by the Director-General Amadou-Mahtar M’Bow to the University of Alexandria on 7 February 1986 was pivotal to this commitment. He met with the Preparatory Committee and visited the site and the Conference Center, which was still under construction. Federico Mayor succeeded Dr. M’Bow as Director-General in November 1987 and promptly renewed UNESCO’s Appeal, reasserting UNESCO’s commitment to the Project implementation, and enlisting it as one of the key components of the World Cultural Decade. Throughout his twelve-year tenure, and until Mr. Matsura succeeded him as Director General in 1999, Dr. Mayor maintained his unequivocal commitment and was keen to conclude the Project Agreements with the Minister to launch implementation. UNESCO Program Director, Mr. Jack Tocattillon, a former Alexandrian, was a devoted supporter from the beginning, so was Mr. Thomas Keller the assistant Director-General. The liaison officers Mr. Salem Hassan, and Mr. Richard Holmquist were also true supporters of the Project development.



Kochiro Matsura, the Director General of UNESCO and Mr. Richard Holmquist were both extremely appreciative of my role in the implementation of the Project. Mr. Matsura wrote to me in his letter of September 5, 2001: “I should like to thank you for your outstanding efforts in the service of this noble Project since its inception. Your excellent collaboration with UNESCO has been greatly appreciated. Your role in this historic undertaking has been essential and will be remembered with gratitude.” Mr. Richard Holmquist, the UNESCO Liaison Officer, said in his farewell letter “Your dedication and hard work was vital for the Project’s perfect development and remarkable realization.”

Ahmed Fathi Sorour and the Ministers of Education

Dr. Sorour was the first Minister of Education who had a leading role in securing national and international commitment to the Project. He succeeded Dr. Fathi Mohamed Ali, who had initiated the first initial requests and communication with UNESCO. He was instrumental in authoring the enactment of the Presidential Decree no. 523 of 1988, creating the General Organization of the Library of Alexandria (GOAL), and the conclusion of the Project Agreement with UNESCO. Upon the recommendation of the University, he met me on 8 February 1989, and issued the decree of my appointment as Executive Director. He gave me full authority to launch GOAL into full operation, with undivided trust. His intelligence, professional prowess, vision and humanistic rapport, thoughtfulness and encouragement are unforgettable, even after his election as a parliament member, and subsequent election as President of the Egyptian Parliament.

Esmat Abdel Meguid

Dr. Abdel Meguid was the Egyptian Deputy Prime Minister, Minister of Foreign Affairs, and a prominent Alexandrian public personality. I knew him since 1965, when I visited him in Paris, where my brother, Dr. Monir Zahran, was working with him at the Embassy. Dr. Abdel Meguid believed in the Project’s role in the future, and that without initial financial support, it could not survive. He insisted that the United Nations Development Program (UNDP) Director-General (William Draper, in New York) provided the needed initial funds for the Project. It was agreed upon exceptionally, and UNDP appropriated US\$ 600,000 which was hiked to \$1.2 million dollars in 1988-89, with UNESCO as the executing agency (EGY/88/003). This was essential to pay for the Competition expenses and prizes, and to finance equipment, expertise, consultancies, and training for the Project once it started up. Appropriate recognition and gratitude are due to this devoted Alexandrian and to his wise diplomacy and fundamental commitment; to catapult the idea into the realm of fruition and ultimate realization.



Sorour, Zahran and UNESCO A. Director General



Zahran with Esmat Abdel Meguid



IEC Meeting

Dr. Abdel Meguid also donated a collection of books from his personal library to the Bibliotheca Alexandrina in 1999-2000.

Fathallah El-Khatib

As Egypt's ambassador to UNESCO, he was instrumental in lobbying among the members of the Executive Board and the General Conference to amass almost unanimous voting for resolutions in support of the Project. Later on, according to ministerial decrees, he chaired the committee for negotiating contracts with the consultants. He was also appointed as chairman of the committee for contractors' qualifications, and pre-selection. The same committee was appointed as the Follow-up Committee to review the Project progress. He was sincere, straightforward, transparent, frank, patient and very professional.

The Governors of Alexandria

Both Counselor El-Sayyed El-Gawsaky and General Mohamed Abdel Salam El-Mahgoub were truly supportive and entirely committed to the Library Project. Whenever an obstacle arose, I found solutions and help from them, unreserved and unconditional. When he was asked why he was implementing such prominent face-lifting urban development Projects in Alexandria, I recall former Governor El-Mahgoub's immediate reply: "The Bibliotheca Alexandrina has inspired, generated and propelled the urban renaissance, befitting the Bibliotheca Alexandrina's magnificence, and the great event of its forthcoming international inauguration". My contacts, cooperation, and association with the two governors secured the acquisition of invaluable rare books and unique manuscripts from the Municipality Library for the Bibliotheca Alexandrina.

Fawzi Abdel Zaher

Fawzi Abdel Zaher was the first undersecretary of the Ministry of Higher Education who witnessed the history-in-the-making of the Project from the beginning, starting from contacts with UNESCO, all the way to the conclusion of all agreements and contracts of implementation. He participated actively, advised objectively and defended the Project faithfully all along, especially after his appointment as Secretary General of the Egyptian National Commission to UNESCO. He was distinguished by his selflessness, transparency, integrity, humility and respectability. He was a rare model in civil service, as a member of the decision-making committee and follow-up committees, and continued his wise and committed role with objectivity and balanced performance, disdain for publicity, and transcendence above human frailties.



Zahran with Governors of Alexandria

The Project Manager

Dr. Giovanni Franco Romerio, a UNESCO civil servant and an Italian national, was the first Project Manager appointed by UNESCO as head of the Executive Secretariat (ES) in the fall of 1991. He worked first from my office at GOAL in the original temporary space at Shatby until the new headquarters were ready in late 1992. Concurrently, I was also appointed as Deputy Project Manager (1991-95), though without remuneration from UNESCO. Dr. Romerio officially and legally answered to the Minister who was Chairman of the International Executive Committee (IEC), according to the Agreement between Egypt and UNESCO. GOAL assisted him by providing facilities, transport, and staff support by seconding professionals to work with him in the Project.

Dr. Romerio worked professionally and was diligent and supportive of the Revival Project. Dr. Romerio remained in this post till June 1995 when he retired.

I always believed that “God said let there be light, and there was light.” In the Bibliotheca Alexandrina there were shining beacons. I wish to especially recognize the devotion and commendable loyalty from the staff of the ES especially Mohammed El-Turgoman, Comptroller, and Laila Dowidar, Executive Assistant, who were dedicated, professional, conscientious, true and trustworthy.

The Consultants

The Norwegian firm, Snøhetta a.s., was the International Architectural Competition first-prize winner. The leading architects were Kjetil Thorsen (Norway), Oyvind Mo (Norway), Christoph Kappeller (Austria) and Craig Dykers (USA). Ehab El-Habbak (Alexandria, Egypt) was a short-term consultant during the Competition, along with Adriana Baillie, Elaine Molinar, Cordula Mohr and Jorunn Sannes (artist for the external wall). Mr. El-Habbak was able to give valuable information on Egypt and Alexandria to the designers, and helped them understand how the new Conference Center would relate to the Library, once built. Snøhetta later on, called upon the services of other firms in Norway, Germany and the UK in associated engineering fields, to prepare the PDR (Preliminary Design Review), which was the basis of the execution design later on. This technical study was sponsored by Norway through a grant to UNESCO, to prove the buildability of the prize-winning concept.

Egyptian law requires that international firms must form joint ventures with Egyptian companies to practice in Egypt. This serves several purposes, including the important transfer of technology and know-how that accompanies such partnerships. After interviewing Egyptian engineering firms, Snøhetta



Zahran with Hamza

selected Hamza Associates from Cairo as their partner. Mamdouh Hamza, who was at that time Associate Professor of geotechnical engineering at the Suez Canal University, had a valuable and relevant experience, distinguished in both design and supervision of execution during implementation. I respected their choice and recommended their consortium to the Minister. Hamza Associates' role was not only the preparation of the contract documents for execution, but also full construction supervision. Mr. Kappeller, as representative of the architects, was always present at the site during the construction phases, together with other British and Norwegian professionals. Jorunn Sannes (Mrs. Thorsen), the artist responsible for the granite wall design, visited the site, traveled and stayed in Aswan working with Egyptian granite subcontractors "Granita", Eng. Hamada Rashwan, and his labor from upper Egypt.

The Construction Monitoring Unit (CMU)

It was necessary to create the CMU to monitor the performance, work schedules, review of monthly statements, overview of the performance and implementation and to watch over activities, receive visitors, as well as oversee quality control and assurance of the construction activities. The engineering staff working for the CMU ensured the faithful and proper execution of the various contracts with the consultants and the construction contractors of Phase I (Foundation and Ground Engineering works, by Rodio/Trevi/Arab Contractors [RTA]), and Phase II (The superstructure and the fit out works, by Balfour Beatty/Arab contractors, [BBAC]).

The Unit monitored both the Consultant's work and performance (Snøhetta /Hamza Consortium had nearly 30 staff members at the site provisional offices), as well as the Contractor's two daily shifts, round the clock, of site work for nearly 1700 workers and technical staff. The performance and weekly reports of the CMU were truly helpful to the Project and to GOAL.

At one time, I was worried about some terrorist incidents that took place in Egypt in the mid-1990s that, given the presence of foreign engineers and foremen at the site from nearly ten countries, might lead to some security problems. I hastened to alert the Governor and Chief of Security in Alexandria to take all precautions to avoid any possible acts of terrorism from within or without. Thank God no single incident of violence, or unrest occurred. Furthermore, although the site was covered by three insurance policies, covering all liabilities, internally and externally, no tragic incidents occurred at the site during the six years of construction and despite the presence of nearly 2000 workers building the Library day and night, 24 hours/day, 7 days/week, 365 days/year.

*Dearest Dr. Zalmay !
 Thanks a thousand
 times for the cooperation
 we have had through
 the last 12 YEARS !*
NESTE NUMBER: BOLIGER
J. Thorsen

Thank you note in June, 2000 by: Snøhetta Chairman

Mr. K. Thorsen

I was keen to maintain a strong human and personal relationship with both the Consultant and Contractor's staff. I made sure to give a group Christmas Dinner to their foreign staff annually together with their families in Egypt as well as a Ramadan breakfast (Iftar) to foster a greater attachment and commitment and hospitality by the owner to those living away from home and their loved ones.

National and International Contributions

The greatest international contribution of US \$65 million was raised, of course, during the International Commission Meeting in Aswan on 12 February 1990, due mainly to the personal contacts of President Mubarak with the Arab heads of state meeting there. During sixteen years of hard work, persistent contacts, tireless efforts, sustained persuasions, coupled with the incredible enthusiasm and unforgettable human response of friends, sponsors and donors world-wide, the total sum of both monetary and in-kind contributions to the Bibliotheca Alexandrina from national and international sources, whether governmental or non-governmental, is estimated at US \$32.4 millions from 46 countries. The total amount of monetary donations received from public and private supporters through fund-raising activities have reached nearly the equivalent of five million Egyptian pounds, which were safely kept at the time of my departure in the National Bank of Egypt as time-deposits to gain interest, thereby serving as seed money for the planned Endowment Fund for the Library continuance. This amount includes the US\$ 700,000 that was the net money made in the Library of Congress Gala dinner in April, 2000 that featured the visit and highly acclaimed address by Mrs. Suzanne Mubarak.

I am happy to note that upon my persistent urging, US Ambassador Daniel Kurtzer, during his third visit to the site on 25 September 2000, pledged US \$20 million of USAID as trust funds in support of the BA. This amount was appropriated in the following year's budget and received and allocated in the present 100 million pounds trust fund.

Contributions of Young People Worldwide

A few flashes of the meaningful human responses to the UNESCO "Appeal" come to mind:

1. A ten-year old approached the contribution box at the Bibliotheca Alexandrina Cairo Book Fair in 1994. After looking at the contribution appeal poster, he took out from his pocket a twenty-five piasters, his entire pocket money, proudly depositing it in the box, saying: "This is my small investment in the future of young Egyptians!"



US Ambassador Daniel Kurtzer

2. A twelve-year old French pupil, upon hearing about the Project from his teacher, mailed a ten-francs banknote with a letter to me in 1992 saying that it was his lunch pocket money, all he owned, and that he was donating it to the renaissance of the Bibliotheca Alexandrina.
3. An elementary school class in Athens collected twenty-five dollars in 1999, and sent the donation check with a letter to me to help with the rebuilding of the Bibliotheca Alexandrina.
4. Egyptian students on applying for the university admission contributed one pound each, during September 1989, which amounted to nearly 30,000 Egyptian Pounds. This amount became the monetary resource of the first Friends of the Alexandria Library Association that I helped found in 1989. This amount was safely kept at the National Bank of Egypt and became the initiation fund for the new Egyptian Friends Association in the summer of 2001.

In addition, there are a few memorable personalities who are hereby duly acknowledged for their meaningful contributions, commendable support and gratifying sentiments:

Neemat Ahmed Fouad

Fouad is a well-known writer, professor and an outspoken social reformer, a loyal and true Egyptian to the marrow. She was the first to donate 500 Egyptian pounds to the University of Alexandria as a contribution to the Revival Project in 1988.

The Alexandrian from Athens

One can never forget the Greek donor, Aris Zavarakis, who visited me in Alexandria's Shallalat headquarters, especially to donate some of the personal effects of the famous Alexandrian Greek poet Cavafy to the New Library of Alexandria. When I thanked him, he broke down in tears crying, and declared that he was an Alexandrian. "Alexandria," he added, "gave me life and I grew up in her riches, care and love, I can never pay her back enough!"

It is noteworthy to mention with appreciation the outspoken support of another famous Alexandrian, Omar Sherif whose unswerving support helped catapult the Project towards completion.

Anastasia Milopoulou (Athens)

Mrs. Milopoulou was born and grew up in Alexandria, was proud to donate her father's library to the Bibliotheca Alexandrina. She broke into tears when this donation was shipped from Greece and presented to GOAL. Her father was a reputed Alexandrian marble contractor by the name of



Zahran with the Greek Team

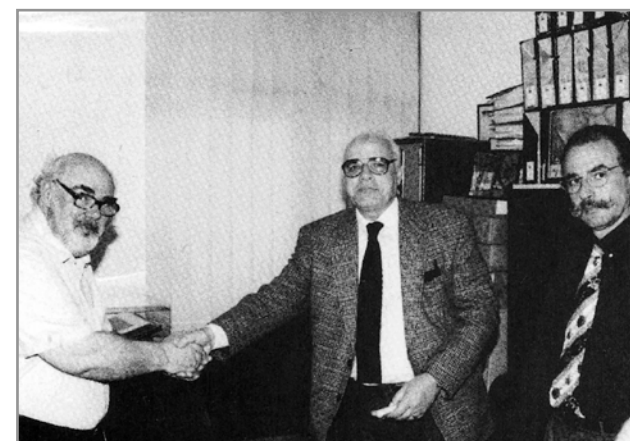

Zahran with Aris Zavarakis, the Alexandrian from Athens

Mikhalidis, who left Alexandria to Greece with his family and possessions, after the nationalization decrees in the fifties. She loved her “home town”, and worked hard with devotion, generosity and sincerity to secure the Greek government and Greek Friends contributions to the Library, supply Bibliotheca Alexandrina’s Antiquities Museum with state-of-the-art display cases, especially made in Athens.

Ms. Milopoulou and her friend Ms. Katerina Koskina, curator of the J.F. Costopoulos Foundation persuaded the Foundation to donate Drs. 55 million toward the cost of the elegant cases. Ms. Milopoulou also organized the donations, commissioning, execution and shipment to Alexandria, with the support of the Greek Government, organizations and Friends Associations, for the statue of Alexander the Great, standing proudly now at the center of the historical square of Shallalat, and the white marble statue of Demetrius, the famed, first Bibliotheca Alexandrina librarian, standing now serenely at the Hall of Fame entrance lobby to the Library. A statue of Alexander the Great and a white marble Stella honoring the ancient Library’s famous librarians, were also commissioned, shipped and displayed in the new Library Plaza of civilization and the Shallalat Square.

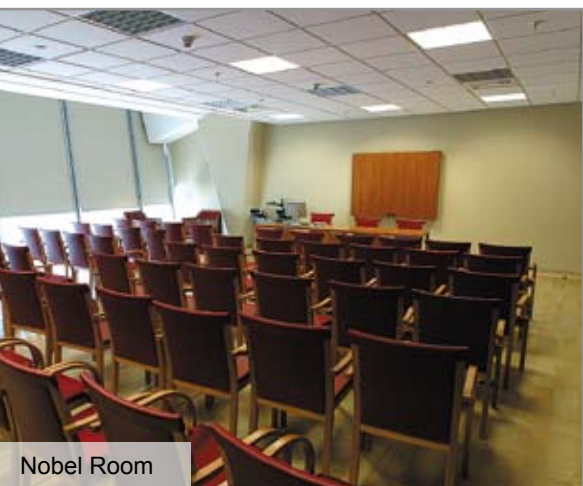

The Nobel Section

I remember that the Swedish Friends and the Scandinavian Committee adopted my proposal to establish the Nobel Section at the Bibliotheca Alexandrina during their visit to the Library site in December 1999. It was gratifying to see it elegantly and thoughtfully implemented. Professor Annica Dahlstrom is to be commended for her commitment, hard work and admirable human kindness. The Nobel Room was to inspire and motivate the scholars at the Bibliotheca Alexandrina to follow the lead in the pursuit of excellence in research and knowledge. She was aided by her colleagues; Lief Hjarre, who works at the Nobel Museum, arranged with the manufacturers to duplicate the beautiful cherry wood furniture after designs in the Nobel Museum in Stockholm. Ulf Tebelius has also worked steadily to collect books by Nobel Laureates (Literature) to make a collection for the Nobel Library. Hans Christian Simensen has worked diligently with Prof. Dahlstrom on the fund-raising program for that donation to continue the programs since then.



Director of the Library of Mines

Jacqueline Leroy was seconded to the Library in 1996 from France. She was hardworking, efficient, and knowledgeable. She contributed greatly to the first Collection Development Policy, and to training the young librarians. She also worked closely with French libraries to select and prepare a major donation

of books. Mrs. Leroy has since worked within the French Friends Association to support the Library's programs and activities.

The Director of BPI

Mr. Gerald Grunberg was seconded in 1998, as advisor to the Project Manager. Before joining the Bibliotheca Alexandrina, he was Director of the Audiovisual Department of the National Library of France (BNF). He became our "in-house trainer" for two years. He worked with me closely and was a great help in training the staff, arranging for French Book donations, urging the French government to support the new Alexandria Library automation and information technology capabilities and organizing seminars, especially those related to the ancient Library. I was both impressed and touched when Mr. Grunberg wrote on a monograph he authored: "To the great management of Mohsen Zahran". Mr. Grunberg returned to Paris in 1999 to become Director of Bibliothèque Publique d'Information (BPI).

The Director-General of French Libraries

During her visit to the great reading Hall of the New Library in 2000, looking at the magnificent cascading levels, hovering above symbolizing a great beacon of knowledge, she was so impressed, that she cried saying: "Mon Dieu! Comme La Cathedral! Why don't you give us your masterpiece, and take ours!"

The Secretary General of the Fulbright Commission in Egypt

Ann Radwan, Secretary General of the Fulbright Commission in Cairo, partially supported my air-travel to Washington from Miami so as to visit the Library of Congress in 1986. She met me in the summer of 2000 in Alexandria. She expressed her appreciation and esteem for my tireless efforts in completion of the Project. She was overjoyed declaring "Oh! My God! You have finally done it! Hats off!"

Teamwork and the Realization of the Dream

In retrospect, real credit and valid recognition are due to the teamwork, close cooperation, direct involvement, sincere dedication and efficient performance of almost all parties and persons working at the site, behind the scene at the offices or associated with the Project. Whether contracted, employed, recruited or volunteered, they have helped me achieve this breathtaking realization and masterly completion of the New Library of Alexandria, this new century world wonder. No wonder the Bibliotheca Alexandrina has won many international prizes and awards, including the recent 2004 Aga Khan Award for Architecture. I am sure more are waiting in line to bestow further deserved glory and brilliance.



EPILOGUE

EPILOGUE

THE CONTINUUM
OF CIVILIZATIONS



The New BA at Night

Many articles have been published recently on the theme of Samuel Huntington's 1993 article on the clash of civilizations, published in *Foreign Affairs*. The theory of the clash of civilizations was promulgated in the international media by many other renowned writers and critics such as Francis Fukuyama. However, recently the University of Chicago's sociology department has published an important report pointing out that religious fundamentalism, extremist movements, and groups engaged in anti-social or anti-cultural violence became especially active during the latter years of the 20th century and at the beginning of the third millennium, in Asia, Europe, Africa, and the Americas. These radical religious movements are reported to belong to the three monotheistic religions or even to other religions and creeds.

The importance of this study lies in the fact that it dismantles all the allegations concerning the clash of Western and Islamic civilizations. It demonstrates that all the theories that testify to the existence of such a clash are baseless and illusory.

After the collapse of the Soviet Union, the US became the sole world power influencing world affairs. Capitalizing on the statements and actions of radical fundamentalist Islamic governments, especially in Iran and Afghanistan, as well as the killing of innocent victims by Islamic fundamentalist operations in various Middle Eastern, African and Asian countries, as well as the USA and Europe, some Western strategists invented a new enemy to fill the vacuum left by the disappearance of the Soviet adversary. At one point, even some Western circles referred to old scars, animosity, and hatred forgotten since the Crusades. Islamic civilization, culture and countries thus became the new enemy.

Forgetting the lessons of history, the true nature of Islam, Islamic culture and values, which preach peace, love, mercy, tolerance, equality, charity, morality, human rights and justice, the advocates of the clash of civilizations forgot that Islam, like all other religions, emphasizes individuality, personal accountability, social order and basic goodness. Thus, respect for other religions has been a basic teaching of Islam, which recognizes variety and respect of differences and opposes subjection or imposed conversion. Freedom of individual choice, humanitarianism and accountability for one's deeds and actions: these are emphasized and manifested even in Islamic cities and architecture, the true mirror of Islamic culture. The built environments of Islamic civilizations differ distinctively in Andalusia, Spain and North Africa from those of Egypt, Syria, Turkey, Iran, Iraq, Pakistan, Malaysia or Indonesia, thus expressing their local environments, heritage, resources, cultures, arts, and capabilities.

The influence of Islamic civilization on Europe and the West has been both varied and vast. Arab scholars of Baghdad and Andalusia transferred knowledge to Europe during the Middle Ages; the Silk Road, which channeled East-West trade, was also an avenue of cultural exchange. The Library of Alexandria was the ancient seat of knowledge and the Egyptian civilization one of the oldest civilizations in the world; from it knowledge and culture radiated to bring light where darkness previously prevailed. The knowledge transferred by Muslim scholars to the West indeed served as the basis of Western civilization.

Consequently, there has never been a “clash” or conflict of civilizations, but rather interaction; a continuum of human civilizations throughout history. Each society, culture and civilization has its own distinctive nature, impact, and contribution to human society. The Bibliotheca Alexandrina is to revive and keep this connection and understanding intact for the best interest of all humanity.

Even those who professed the need for new dialogues or debates among civilizations also forgot that debate has been taking place through many international and regional organizations, forums,

institutions, in addition to the media. The late Pope John initiated a meeting of representatives of different religions to emphasize the need for greater understanding, tolerance, peace and collaboration among world faiths. Furthermore, George Cary, head of the Anglican Church, and Grand Sheikh Tantawi of Al-Azhar, signed a protocol for the promotion of greater dialogue between their religious institutions.

Thus, the issue here is not, from my perspective, as some claim, the lack of debate between cultures, since many governmental and non-governmental organizations and institutions concerned with this issue have been involved in creating and establishing such debates, linkages, cooperation and maintaining open communication. The 6.5 billion people who make up the UN Charter countries represent many channels for intensifying cooperation and creating highways to bring all countries into the new globalization.

The challenge is not to start debates or dialogues, but to make existing institutions more effective, more productive and engaging, by creating new avenues of cooperation and communication. We do not necessarily need more debates; rather, we must promote the goals, substance and results to reduce grievances, alleviate suffering, eradicate injustice, salvage human diversity and eliminate despair.

Recent history contains many examples of partnerships, regardless of the partners' diversity and differences. Of these, two major channels or avenues can be explored: the Intangible Avenue (essentially cultural, social, scientific and intellectual); and the Tangible Avenue, (basically technical and operational).

The Intangible Avenue aims at creating and reinforcing systems and frameworks for dialogue and partnership among civilizations that share cultural or environmental roots. An obvious example of a region of common heritage and potentials is the Mediterranean basin. By capitalizing on the Barcelona Forum and the European Union experiment, many programs seeking new horizons of collaboration can be conceived. The new Bibliotheca Alexandrina is the forum, the name and the arena. Similar examples abound in the African and Arab worlds. Frameworks and foundations capable of ensuring greater cooperation, confidence, credibility, openness, transparency, and partnerships are necessary, as are attainable pragmatic goals, to maximize complementarities and synchronized integration according to a short, medium and long-range plans of action.

The second avenue, concerned with institutional, material and implementation aspects, is directly dependent on the pursuit of the first. Currently the dawning of the new Alexandria Library will initiate, promote and support a great momentum along this avenue and the fulfillment of this goal. It will become a

window onto the world for Egypt and onto Egypt for the world as Mrs. Suzanne Mubarak, Chairperson of the Library's Board of Trustees, has emphasized. Here is a great potential and magnificent framework for the manifestation of the continuum of civilization, as demonstrated in the ancient Library.

Circles of cooperation can extend to link other neighboring regions in the Middle East, the Arab world, Africa, and beyond. These regional alliances and partnerships can create a multi-polar galaxy, with prominent nodes of radiance and great influence, in the service of all toward a better future of mankind everywhere.

Nearly 50 per cent of world communities are made up of young people. We owe them the promise of a brighter future, given the great technological revolution, spreading globalization, and breakthroughs in information and communication technology and outer space discoveries in the third millennium. The New Bibliotheca Alexandrina is the appropriate forum and arena for the achievement of this goal.

What is essential is greater understanding, conviction and a common will to act effectively and quickly, conquer backwardness, eliminate socio-economic injustices and promote avenues of trust, democracy, dialogue of understanding and collaboration. Thus can we generate hope, and map out new frontiers for the realization of the grand goal of the continuum of civilizations.

The challenges are surmountable, the difficulties are numerous but not insuperable, the resources are available, and the horizons of hope and progress are both vast and promising.





“ It is the mind that makes the man, and our vigor is our immortal soul!”

Ovid

APPENDICES

LIST OF APPENDICES

UNESCO APPEAL	202
BIBLIOTHECA ALEXANDRINA ARCHITECTURE AND ENGINEERING AWARDS	204
ADDRESS BY H.E. PRESIDENT MOHAMED HOSNI MUBARAK	205
STATEMENT OF HIS HIGHNESS SHEIKH ZAYED BIN SULTAN AL-NAHYAN	207
ASWAN MEETING OPENING ADDRESS BY MRS. SUZANNE MUBARAK	208
ADDRESS BY MR. FEDERICO MAYOR	210
MEMBERS OF THE INTERNATIONAL HONORARY COMMISSION FOR THE REVIVAL OF THE ANCIENT LIBRARY OF ALEXANDRIA PARTICIPATING IN THE ASWAN MEETING	214
THE BOARD OF THE GENERAL ORGANIZATION OF THE ALEXANDRIA LIBRARY (GOAL)	215
INTERNATIONAL EXECUTIVE COMMITTEE (IEC)	216
INTERNATIONAL EXPERTS/CONSULTANTS INVOLVEMENT WITH THE BIBLIOTHECA ALEXANDRINA	218
NATIONAL SHORT-TERM CONSULTANT MISSIONS TO THE BIBLIOTHECA ALEXANDRINA	226
NATIONAL PERSONALITIES	234
EGYPTIAN CONSULTANTS TO THE PROJECT	235
INTERNATIONAL SUPPORTERS	235
BIBLIOTHECA ALEXANDRINA - A BRIEF CHRONOLOGY	237
PTOLEMAIC TREE	243
ALEXANDRIA'S ANCIENT SCHOLARS	244
AT THE THRESHOLD OF THE THIRD MILLENNIUM	245
ACKNOWLEDGMENT OF CONTRIBUTIONS RECEIVED (UP TO 2001)	247
NORWEGIAN GIFT OF FRONT HOUSE FURNITURE	251
LIST OF BIBLIOTHECA ALEXANDRINA PUBLICATIONS (GOAL)	252
COUNTRIES/PARTICIPANTS IN THE INTERNATIONAL ARCHITECTURAL	

COMPETITION	253
BIBLIOTHECA ALEXANDRINA BUILDING STATISTICS	256
TOTAL QUANTITIES OF PHASE I	257
TOTAL QUANTITIES OF PHASE II	258
THE NEW BIBLIOTHECA ALEXANDRINA FUNCTIONAL AND SPATIAL ALLOCATION	261
ARAB REPUBLIC OF EGYPT PRESIDENTIAL DECREE NO. 523 OF 1988	272
LAW NO. 1 FOR THE YEAR 2001	277
PRESIDENTIAL DECREE NO. 76 FOR THE YEAR 2001	280
BIBLIOGRAPHY ON THE LIBRARY OF ALEXANDRIA	283
PROJECT CREDITS	296

UNESCO APPEAL

by Mr. Amadou-Mahtar M'Bow

Director-General

(Paris, 22 October 1987)

and

Mr. Federico Mayor

Director-General

(Paris, 10 May 1996)

IN SUPPORT OF THE REVIVAL

OF

THE LIBRARY OF ALEXANDRIA

Alexandria, standing at the crossroads of the main communication routes of Africa, Europe and Asia, was a major centre of science, philosophy and art, an intellectual meeting place for eminent representatives of the Egyptian, Greek, Persian and other cultures, where they could dialogue and receive mutual benefit from their contact.

It was in such a climate that the first universal library in history, which was also a research institute and a museum, came into being at the beginning of the fourth century BCE, having as its aim the bringing together and conservation of the writings of all nations and at the same time welcoming their leading scholars and thinkers.

From a very early point in its history, at least one copy of every work written in Greek, and subsequently of translations of the most important works written in other languages, was added to its collections. All ships passing through the port of Alexandria were required to allow copies to be made of any scrolls they had on board, if they were of interest to the Library.

By the middle of the first century BCE, the Library had in its possession 532,800 manuscripts, which were listed, filed and preserved by highly sophisticated methods. One of its finest achievements was the "Pinakes" of Callimachus, a catalogue of all existing works, which not only gave their titles but also supplied detailed information on the authors and their works, as well as analyzing each text. This gigantic bibliography, now lost, was for a long time the essential reference work for Greek literature.

The Library of Alexandria was one of the leading intellectual centers of the world. Having assembled a unique collection of scientific, philosophical and literary works, it was also a haven over the centuries for numerable authors who found their source of inspiration there.

The Egyptian government has done all it can to provide the best possible conditions for the implementation of this Project. A Higher National Council of the Library of Alexandria has been set up under the patronage of the President of the Arab Republic of Egypt.

For this exceptional undertaking to have its proper worldwide dimension, however, the Egyptian Government plans to involve the entire international community therein. For this reason it has asked UNESCO to support its action, particularly by means of an appeal to universal solidarity. The Executive Board of the Organization thus invited me, at its 126th session, to launch such an appeal.

I therefore call on the governments of all States, international governmental and non-governmental organizations, public and private institutions, funding agencies, librarians and archivists, and last but not least, the peoples of all countries to participate, by means of voluntary contributions in cash, equipment or services, in the immense effort undertaken by the Egyptian Government to reconstruct and equip the Library of Alexandria, constitute and preserve its collections and train the requisite personnel.

I call on all intellectuals, artists and writers, historians and sociologists, and on all those whose work it is to inform journalists, columnists, professionals, of the press, radio, television and cinema to help develop public awareness in all countries of the universal dimension of the Project for the revival of the Library of Alexandria, and to encourage them to contribute to its implementation.

I especially invite the publishers of literary, scientific and artistic books and periodicals the world over to send two copies of each of their publications to the Library of Alexandria, beginning on 1, January, 1988.

It is my hope that the contributions will be commensurate with the vast task ahead, and that all those concerned with the conservation of the universal documentary heritage and wish to promote the widest possible use thereof by researchers and members of the public all over the world, will participate with enthusiasm in the international campaign for the revival of one of the most prestigious institutions in the history of mankind.

Amadou-Mahtar M'Bow

(signed)

Paris, 22 October 1987



The Aga Khan Award for Architecture
is presented to

Bibliotheca Alexandrina

An Outstanding Contribution to Architecture for Muslims

on this day
14 Shawwal 1425
27 November 2004
in Delhi, India

by
His Highness The Aga Khan
upon recommendation of
The Master Jury

Aga Khan

BIBLIOTHECA ALEXANDRINA ARCHITECTURE AND ENGINEERING AWARDS

Year	Title	Country
2001	International Performance of the Year Award Winner Quality in Construction Awards 28 March	UK
2002	ASCE OCEA Award of Merit American Society of Civil Engineers, OPAL Award 27 April	USA
2002	Africa and Middle East Award, World Architecture Awards 25 July	Germany
2002	DFI Special Recognition Award, Deep Foundations Institute 10 October	USA
2002	ICE Bill Curtin 2002 Medal for Paper “Back to the Future – Alexandria’s New World Library”, Institution of Civil Engineers 4 November 2003	UK
2003	IABSE 2003 Outstanding Structure Award International Association for Bridge and Structural Engineering Symposium 27 August	Belgium
2004	Aga Khan Award for Architecture 27 November	India



ADDRESS BY H.E. PRESIDENT MOHAMED HOSNI MUBARAK**President of The Arab Republic of Egypt**

President François Mitterrand, President of the Republic of France,
Sheikh Zayed Ben Sultan Al-Nahyan, President of the United Arab Emirates,
Your Majesties,
Your Excellencies,
Your Highnesses,
Mr. Federico Mayor,
Ladies and Gentlemen,

It's a real pleasure to welcome you in Egypt and on the soil of Aswan which attests to the longevity and immortality of the Egyptian civilization, one of the oldest civilizations in the world. Egypt, is grateful to your positive participation in this Project. You are giving the best example of enlightened leaders and pioneers who despite cultural, political, economic, and social burdens, understand the importance of such a Project and are determined nevertheless to play a role in the revival of one of the oldest seats of knowledge. The revival of the new Library of Alexandria is a universal undertaking which invites all people to participate wherever they are, regardless of their political or national affiliations. Indeed, your participation in this ambitious cultural Project merits special praise.

Your support is reminiscent of the rescue campaign saving the Nubian monuments from the Aswan High Dam's water. Your great contribution helped save those temples and preserve their grandeur. Thus, Abu Simbel bears witness to the Egyptian civilization, to the international community's awareness and dedication, as well as, to the profound feelings of solidarity and unity in the face of challenges. Today, while you are participating in reviving the Alexandria Library you are giving an example of this awareness thereby deserving every appreciation and gratitude. However, it is important to realize that your participation is for a universal cause; the Library is to become an international beacon of knowledge serving Egypt, the region and the whole world. In this way your participation becomes primarily an act for all humanity.

The history of the Library of Alexandria, affirms that it welcomed all seekers of knowledge regardless of color, origin, or religion. At this early juncture in human history, this was a clear statement of human equality, invoking all the lofty principles and values called for by the great revolutions of the world. The revival of the new Library will resonate in all circles interested in cultural heritage, with all its international dimensions.

Science, art, thought and culture constitute the bedrock of the Egyptian civilization. They promote peace and understanding amongst the peoples of the world. As a result, man advances, values peace, appreciates the right of others to a free and honorable life, rejects oppression and avoids conflicts and wars.

Egypt is aware of its cultural role, and conscious of the duties imposed upon it by its geographic location, historical background and cultural heritage; it has nurtured one of the most sublime cultures, safeguarded the great religions and was a sanctuary to prophets and messengers. Thus, the Bibliotheca Alexandrina, the renowned civilization symbol will encompass all old documents, encyclopedias, and hand-written manuscripts that deal with Egypt, the Mediterranean basin, Africa and the Middle East. A special emphasis is given to Alexandria as a meeting point of all these regions, and as an ancient capital. On the soil of Alexandria, the ancient Egyptian civilization merged with the Greek, Roman, and Arab civilizations.

The Library shall offer to researchers and scholars from all over the world academic services of the highest levels using the latest technology. Egypt has decided to carry out this colossal task, and give it top priority in spite of the tremendous burdens in the fields of development, and the challenges it faces in its comprehensive economic reform. Egypt can never relinquish its pioneering cultural role, which it plays by virtue of its history and location. Therefore, Egypt has initiated the idea of reviving the Alexandria Library because it believes that not on bread alone does man live, but that culture is the food of thought, conscience and feelings, and this is of no less importance to man than his material needs.

Egypt is the land of civilization, knowledge, art, peace and culture. Needless to say, its national policies are based on humanitarian principles recognizing the basic rights of man. As such, Egypt's future shall not simply depend on its history and location, as the gateway to Africa, the road to Asia, but, above all, shall thrive as the lifeblood of the Arab World, the third "Kibla" of the Islamic World and a helping hand to the countries of Africa and the third world.

Ladies and Gentlemen,

On behalf of myself and the Egyptian people, I extend thanks to you. Egypt builds with one hand and develops civilization with the other. Just as it built the High Dam of Aswan in the past, it is embarking on the revival of the glorious Alexandria Library in the present. Long live Egypt as a symbol of civilization, and long live our lasting friendship with your countries and peoples.

Thank you

**STATEMENT OF HIS HIGHNESS SHEIKH ZAYED BIN SULTAN AL-NAHYAN,
PRESIDENT OF THE UNITED ARAB EMIRATES, DELIVERED IN HIS PRESENCE BY
MR. AHMED KHALIFA AL-SOWEIDY**

Mr. President,
Majesties,
Excellencies,
Highnesses,
Ladies and Gentlemen,

It gives me a great pleasure and honor on behalf of his highness Sheikh Zayed Bin Sultan Al-Nahyan, President of the United Arab Emirates, to announce his contribution of US \$20 million as a donation for the rebuilding of this unique project of the Revival of the Ancient Library of Alexandria, so that it becomes an international cultural beacon and a lighthouse for the continuity of civilization in Egypt, the land which is the cradle of all human civilizations.

There is no doubt that the carrying out of this project will certainly be one of the most important cultural achievements in this decade. I would also like to point out the important role UNESCO has undertaken in adopting this project. We are also grateful for the efforts of Mrs. Mubarak who is the head of the International Commission responsible for the execution of the project.

Thank you





**ASWAN INTERNATIONAL MEETING OPENING
ADDRESS BY MRS. SUZANNE MUBARAK**

Chairman of the International Commission of the Alexandria Library

Majesties, Highnesses and Excellencies,
Members of the International Commission for the Revival of the Bibliotheca Alexandrina,

Dear Guests,

With all sincere feelings, I reach out to welcome you in this amicable, civilized and human gathering on the land of Aswan. I reach out to thank you for your participation and enthusiasm in reviving this revered vestige, thus confirming your belief in the stature of Egypt; and your appreciation of Egypt's historical role, credit to civilization, and unfaltering effort for the progress of mankind.

The core of this great gathering is the book, and the book in our history, civilization and culture is the sublime symbol of knowledge. It is worthwhile to remember that the ancient Egyptian has engraved on stone his cherished values and recorded on papyrus all his valuable knowledge. Similarly, the modern Egyptian believes that the first revelation from God to the Prophet Mohamed was "read;" the "Pen" in the Koran was later mentioned in the same verse as the greatest gift from Almighty God to mankind. Throughout successive ages and eras, in the land of Egypt the book has remained always a symbol that Egypt and its people endeared. Such has been the case throughout the Pharaonic, Roman, Coptic and Islamic epochs: our country believes in the book, treasures libraries and considers the written word as a precious treasure of an esteemed value.

From such a deep belief in the value of books and libraries came the interest in reviving the ancient Library of Alexandria, an encyclopedic and international academic phenomenon which remained an emblem of intellectual knowledge, a center of refined arts and advanced sciences and a refuge for the greatest scientists, philosophers, intellectuals and artists around the world.

The participation to revive this ancient renowned Library is a living token of the value of civilization. The cooperation and welfare of human heritage are invoked by great minds, pursued by perceptive generations and retained by the immortal Egyptian civilization. Today's meeting is also a special appreciation of Egypt and its role, a highlight of its history and a consolidation of its efforts toward progress. This deserves our true appreciation and gratitude to you for coming to partake in this historic meeting.

The whole world looks forward earnestly, in anticipation of what would be achieved by the participants in this project, having you as an elite vanguard to restore to the human culture, an academic international center that was lost for centuries, and for whose return there is an utmost need.

As we all know, this Bibliotheca Alexandrina will include encyclopedias, periodicals, books and documents that are related to Alexandria, Egypt, the Mediterranean and the Middle East. When we mention Alexandria, we remember what once thrived on its land of Greek and Roman heritage. When we mention Egypt, we recognize a fusion of long centuries passed, centuries of knowledge and art, the dawn of inspiration of

human civilization and a sunrise for humanity. When we mention the Mediterranean, we remember the leading role of the early philosophers, the avant-garde of mathematics, science and refined arts during the ages of Roman and Greek glory. When we mention the East, we recall the civilizations of the great religions and God's messages that taught mankind the finest values and principles, and saved him from the ages of darkness.

Dear members,

Political ideologies might separate countries, and economic interests may cause gaps among people, but culture alone is a unifying rather than a dispersing element. Human knowledge, which is the treasure from which we pay our contributions today, is a credit to our future.

The rebirth of the Alexandria Library is a unique incident which we esteem and put in its appropriate place among the great cultural events, and it is a distinguished sign of civilization, because it is an event that man cares about everywhere despite different geographies, political inclinations or religions. Culture unites all nations and people, and is the hope of the contemporary individual for a better future.

We shall always recall this international effort to revive the Bibliotheca Alexandrina, and let this honorable gathering of prominent figures from the different nations of the world be a proof of this general understanding of the meaning of the Revival of the Bibliotheca Alexandrina. It will be a center that unites together the Arab, Islamic and international heritages, and a continuous message to our future generations.

Dear members,

I cannot end my speech without expressing my sincere appreciation and thanks for your presence, and my pride in your attendance of this meeting, which emphasizes a noble motive and a refined cultural event. A special greeting is due to UNESCO, its director, its various departments and their experts, for their wonderful efforts and their dedication to bring the Alexandrina back to life, so that it may become an exalted symbol of civilization and culture.

May God help us to promote a better human knowledge unbounded and unlimited. These moments will always remain an inspiring light that will illuminate our path ahead.

Thank you.

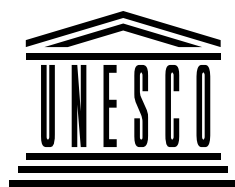

ADDRESS BY MR. FEDERICO MAYOR

Director-General of the United Nations Educational, Scientific and Cultural Organization (UNESCO)

Thirty years ago, the greatest archaeological rescue campaign of all time was initiated when the Director-General of UNESCO, Rene Maheu, launched his appeal to the international community to save the treasures of Nubia. Twenty years later the campaign had been successfully completed, following a spectacular engineering operation that lifted the temples of Abu Simbel and Philae beyond the reaches of the rising waters of the High Dam.

The same land, the same river valley that cradled and nurtured one of the earliest and most enduring of the world's greatest civilizations gave rise, in the third century before our era, to one of the most splendid and lasting achievements in the history of human thought: the creation, in the cosmopolitan city of Alexandria, of a great library and museum endowing humanity with a collective memory and a new concept of knowledge. The idea that crystallized in the ancient Library of Alexandria was the start of an intellectual venture that has shaped the world in which we live. One thinks of Rimbaud's orphic celebration of creative reason: "Arrivée de toujours, qui t'en iras partout". Today it is the international community, represented by UNESCO and by the distinguished members of the International Commission for the Revival of the Ancient Library of Alexandria, that is meeting here in Aswan to celebrate this universal heritage and, in particular, to pledge its support for a project that will commemorate and perpetuate the spirit of the Library of Alexandria at its place of genesis.

At the heart of the Alexandrian enterprise that drew scholars from all over the Hellenistic world to study, discuss, investigate and create was a sense of wholeness, of the radical interdependence of natural phenomena. No work was excluded from the Library of Alexandria; the nine muses dwelt in harmony within the halls of its Museum, in the person of an Eratosthenes, the scientist, philosopher, mathematician, historian, critic and poet were reconciled.

Allied to this universal vision was a new sense of critical and empirical enquiry, evident no less in the scholarly editing of texts than in the elucidation of natural phenomena. While earlier thinkers had grasped the importance of logical or mathematical explanation, the Alexandrian school developed a tradition of weighing the evidence, testing theory by means of observation and experiment, accommodating the awkward fact.

Finally, the scholar-scientists in the service of the Ptolemies and their successors pioneered the concept for research, of purposive and systematic enquiry, of the quest for knowledge as a collaborative endeavor.

The result was a unique flowering of learning over some six centuries. Eratosthenes, by comparing the length of the shadows cast at the summer solstice in Alexandria and Syrene (or ancient Aswan), calculated with astonishing accuracy the circumference of the Earth and envisaged the possibility of passing "by sea from Iberia to India". Aristarchus posited a heliocentric solar system and assimilated the sun to the fixed stars. Herophilus identified the brain as the locus of intelligence. Euclid systematized

geometry. Dionysius elaborated the rules of syntax. Ptolemy mapped, after a fashion, the continents and the heavens. Heron devised the steam engine and Archimedes displayed his genius in a whole series of mechanical inventions.

The ultimate fate of the Ancient Library of Alexandria is a sobering reminder of how fragile the constructs of the civilized mind can be. The great store of art and learning contained in its half a million or so scrolls, the memory traces of a civilization, were virtually wiped out in the political and religious convulsions of the late Roman Empire. The achievements of Alexandrian science were forgotten for over a millennium as the broad search for truth yielded to the narrow quest for certainty. Forgotten but not entirely lost to posterity. The seeds of some of this knowledge lay dormant awaiting the time when a new spiritual climate would allow them to throw forth fresh shoots in the fertile mind of a Copernicus or a Columbus.

The partial survival of Alexandrian science in the scrolls of Constantinople or the studies and translations of Arab scholars highlights the seminal function of the written word, whether inscribed on stone, parchment, paper, microfilm or computer disk. The written word spans time and space. Organized in the form of the library, it connects us — in the words of Carl Sagan — "with the insights and knowledge, painfully extracted from Nature, of the greatest minds that ever were, with the best teachers, drawn from the entire planet and from all of our history, to instruct us without tiring, and to inspire us to make our own contribution to the collective knowledge of the human species". The support we give to libraries is a measure of our concern with the foundations of our own culture.

Egypt is thus to be warmly congratulated on its initiative to revive the Ancient Library of Alexandria. Great credit is due, in particular, to the University of Alexandria, which has fostered the project since 1974; to Minister Fathi Sorour, who made it a national undertaking; and, finally, to President Hosni Mubarak who had the vision to see that the venture had an international dimension calling for the co-operation of the international community.

It is particularly appropriate that this project should be launched at the start of the World Decade for Cultural Development. Under the auspices of the United Nations and UNESCO, the Decade seeks to ensure that the cultural dimension is duly taken into account in national development plans, to stimulate creative talent and cultural life as a whole through the affirmation of cultural identities, to foster broader participation in cultural life and to promote international cultural co-operation. The Bibliotheca Alexandrina, by assembling a major collection focused particularly on Egyptian, Middle Eastern, Greek and Arab civilizations and on the Islamic heritage and by making it available to researchers from Egypt, the Middle East and the rest of the world, should further in a very real way the objectives of the Decade.

It is worth insisting on the fact that the new Library is intended to be a public research library. This was a dimension of universality that the Ancient Library of Alexandria never knew. Knowledge to the Ancient World was the preserve of an elite. There was no popularization of the findings of

the scholar-scientists of Alexandria. This may partly explain why Alexandrian science never took deep root in its own time and why it was eventually swept away by more elemental historical forces. The new Bibliotheca Alexandrina, by making its collections and services publicly available, will reflect a more truly universal conception of the quest for knowledge — one based on the idea of knowledge as a collective achievement that should serve to promote the development of all.

The Project for the Revival of the Ancient Library of Alexandria goes to the very heart of UNESCO's mission. Our task is, in essence, to promote the sharing of knowledge — knowledge for its own sake, knowledge for development and knowledge for mutual understanding. Sharing implies diversity and thus, by extension, the promotion of those cultural identities that constitute the harmonic richness of the concert of nations. By the same token, it presupposes the protection of the cultural heritage in which our national and supranational identities are rooted. By co-operating with Egypt in the task of integrating its rich past in a network of information with global ramifications, UNESCO is acting in full accord with its own purposes and is preparing the way for the future constitution of a truly global system of information networks.

The task before us now is to bring to fruition the first project of its kind to be undertaken with the help of the international community. With the generous help of the United Nations Development Program, which has co-operated since 1988 with UNESCO and Egypt in this joint venture, the first, preparatory phase of the project is complete. The time has now come to focus all our efforts on the campaign to raise the funds required to construct the building, to purchase equipment, constitute the book collections, train staff and organize and run the library and its associated services.

There are those who will say 150 million dollars is a high price to pay for the construction of a library when so many apparently more pressing needs clamor for our attention. This, however, is to forget that knowledge is the supreme resource because it is cumulative and is the key to meeting so many basic needs. Are we to place a lower value on a library than on a super bomber? At a time when the disarmament momentum is growing, the promotion of knowledge deserves to be one of the first 'peace dividends'.

I believe that this project, no less than that which safeguarded the treasures of Nubia for posterity, will mobilize the support of the international community. In this connection, it seems to me essential that the international community should be involved in this historic undertaking at a deeper level than simply through the provision of the necessary funds. UNESCO is ready to continue its cooperation in order to guarantee the international dimension of the project, providing its services in fund raising and management and project implementation and also, subsequently, in the task of ensuring the full development of the potentialities of the Library at the national and international level.

The Project for the Revival of the Ancient Library of Alexandria is fortunate indeed to count among the members of its International Commission so many eminent figures from such diverse cultures and spheres of activity. I wish to thank most sincerely all the members of the Commission who have set

aside time in their very busy schedules to lend their personal support and prestige to this Project. I take the opportunity likewise to express my appreciation to Mrs. Mubarak for agreeing to chair the Commission and to the Egyptian authorities for offering us such excellent hospitality.

Excellencies, Ladies and Gentlemen,

The Nubian campaign glows brightly as an example. May this meeting serve to light a flame of enthusiasm that will be transmitted, through you, to all parts of the world, rekindling in the process the ancient and perennial beacon of the Bibliotheca Alexandrina. Let us all together, by mobilizing support throughout the world, give to this venture of Egypt, of all the people of Egypt, the resources it so richly deserves. In reviving this splendid and creative legacy of the past, we are forging a brighter common future. What better symbol of our vision than a library — as Jorge Luis Varges suggested when he wrote in his "Poema de los dones": "Yo, que me figuraba el Paraiso / bajo la especie de una biblioteca". Marguerite Yourcenar interpreted his dream — our dream too — in these words: "*Jadis, quand je rêvais à la terre promise, c'est une bibliothèque que je voyais*".



MEMBERS OF THE INTERNATIONAL HONORARY COMMISSION FOR THE REVIVAL OF THE ANCIENT LIBRARY OF ALEXANDRIA PARTICIPATING IN THE ASWAN MEETING

Her Majesty Queen Sofia of Spain

Mr. François Mitterrand, President of the Republic of France

Her Majesty Queen Nour Al Hussein of Jordan

Mrs. Suzanne Mubarak, Egypt, Chairman of the International Commission for the Revival of the Ancient Library of Alexandria

Her Highness Princess Caroline of Monaco

Mr. Yehia Bin Mahfoud Al- Mantheri , Minister of Education and Youth (Sultanate of Oman)

Mrs. Suzanne Agnelli , Senator, Under-Secretary of State for Foreign affairs (Italy)

Mr. Ahmed Fathy Sorour, Minister of Education, Chairman of the General Organization of the Alexandria Library (GOAL)-Egypt

His Royal Highness Prince Turki Ibn Abdel-Aziz Al-Saud, Founder and President of the Arab Student Aid International (ASAI), (Saudi Arabia)

Lord Briggs, Provost, Worcester College, Oxford (UK)

Mrs. Gro Harlem Bruntland , Member of Parliament (Norway)

Mrs. Melina Mercouri, Member of Parliament (Greece)

Mr. Abdul-Aziz Hussein, Advisor to his Highness the Amir of Kuwait

Mr. José Israel Vargas, Former Chairman of the Executive Board of UNESCO (Brazil)

Mr. Hans-Peter GEH, President of the International Federation of Library Association (IFLA) (Federal Republic of Germany)

Dr. Daniel Boorstin, Historian, Librarian of Congress Emeritus (United States)

Professor Dimitri Sergeevich Likhachev, Academician (USSR)

THE BOARD OF THE GENERAL ORGANIZATION OF THE ALEXANDRIA LIBRARY (GOAL)

- Ahmed Fathi Sorour, Minister of Higher Education, Chairman
- Mohamed Said Abdel Fattah, President of Alexandria University, Vice-Chairman
- Mohsen Zahran, Executive Director of GOAL
- Ministry of Culture Representative
- Ministry of Education Representative
- Ministry of Foreign Affairs Representative
- Ministry of Information Representative
- Ministry of Tourism Representative
- University of Alexandria - three representatives: Mohamed Loutfy Dowidar, President; Galal Tharwat, Vice-President; Omar Abdel Aziz, Dean Faculty of Arts

Four public personalities:

- Mohamed Sobhi Abdel Hakeem
- Sarwat Okasha
- M. Fathallah El Khatib
- Shawky Deif
- Ahmed Bahaa El Din

First meeting with held on 26 August 1989

and the Second meeting on 23 September 1990



INTERNATIONAL EXECUTIVE COMMITTEE (IEC)

Egypt

- Fawzi Abdel Zahar, Secretary General of the Egyptian National Commission for UNESCO
- Hussein Kamel Bahaa El Din, Minister of Education (1992-1997)
- Moufid Shehab, Minister of Higher Education and Scientific Research, Chairman (1997-2001)
- Mamdouh El-Beltagui, Minister of Tourism
- Mohammed Mahmoud El-Dakrouri, Vice-President of the State Council of Egypt
- Mohammed Fathallah El-Khatib, former Ambassador to UNESCO
- Mohamed Said Abdel Fattah (1988-1993)
- Essam Ahmed Salem, President, University of Alexandria (1993-1998)
- Mohamed Nasr El Din Domair (1998-2001)

France

- Jean-Marie Arnoult, Direction du livre et de la lecture, Ministère de la Culture et de la Communication

Greece

- Solon Kydoniatis, Member of the Hellenic Academy

Italy

- Francesco Aloisi de Larderel, Ambassador of Italy to Egypt

Norway

- Ingrid Eide, President National Commission for UNESCO

Oman

- Aly Berake El-Rabeey, Ministry of National Heritage and Culture

Saudi Arabia

- Hamad Ibn Mohammed Al Shaghroud, General Director of Abha Educational District

Turkey

- Süleyman Türkman, Assistant Director, Regional Library of Manuscripts

United Arab Emirates

- M. Hamad Abdel Rahman El-Medfaa, Minister of Education

United States of America

- Robert Rohlf, Partner - Professional Library Consultants

UNESCO

- Federico Mayor, Director-General

Rapporteur

- Giovanni F. Romerio, Giovanni F." , Project Manager and Head of the Executive Secretariat (1992-1995)
- Mohsen Zahran, Executive Director of GOAL and Project Manager (1995-2001)

Observers

- UNDP Resident Representative, UNESCO Cairo Office Representative

Three meetings: 26 June 1992, 1 December 1993, 5 May 1997



Third IEC Meeting

**INTERNATIONAL EXPERTS/ CONSULTANTS
INVOLVEMENT WITH THE BIBLIOTHECA ALEXANDRINA
NAMES OF ADVISORS AND SUPPORTERS
2001**

Country/Entity	Name	Field
Arab League	Dr. Faisal Al Hafyan, Arab League, Institute of Arab Manuscripts and Heritage	First Annual International Symposium, 1998
Canada	Ms Audrée Breton	Intern (Archaeology Museum), 2000
Canada	Eng. Hazem Osman Ali	Intern (Architect) 2000
Canada	Dr. David Jordan, Canadian Research Center	Second International Symposium (Collection Development), 1995
Denmark	Mrs. Susanne Ornager, Royal School of Librarianship	CDS ISIS training, 1994
Finland	Mrs. E. Törnudd, Helsinki Univ.	Library Affairs, 1994
Finland	Mrs. A. Haarala, Helsinki Univ.	Outline Design, 1994
France	Mrs. Jaqueline Leroy, Bibliothèque de l'Ecole des Mines	Assistant to the Project Manager for Library Affairs, 1995-1996
France	Mme. Martine Blanc-Montmayeur, Bibliothèque publique d'information (BPI)	Symposium, 1998
France	Mme. Souad Hubert, BPI	Symposium, 1998
France	M. Laurent Guellot, BNF	Symposium, 1998
France	M. Jean-Pierre Sakoun, publisher	Symposium, 1998
France	Mme. Patricia Landu-LaFume, Bibliothèque de Limoges	Training

Country/Entity	Name	Field
France	Mme. Michèle Delaygue, French Commission for UNESCO	Training, 1995, 1997, 1998
France	Mr. Gérald Grunberg, BNF	Library Affairs 1997-2000
France	Mrs. Françoise Lerouge, ENSSIB	Library Affairs, 1995, 1996, 1998
France	Mr. Michel Choleau, Sablé	Training-Conservation Laboratory, 1996
France	Dr. J. Keriguy, ENSSIB	ISIS-1994
France	Ms. Jacqueline Domenach	Business Center, 1998
France	Mme Linskens, Paris	CNED, 1998
France	M. Jean-Paul Oddos	Pompidou Center, Training – Conservation and Restoration Lab.
France	M. Yan Marchand	Intern, Young Peoples' Library, 1998
France	Association de Ferdinand de Lesseps	Suez Canal documentation and archives, 1998, 1999, 2000
France	Ms. Nazli Farid	French Cultural Center-language training, CNED training
France	Dr. Christian Jacob, CNRS	2 nd BA Annual Symposium, Parts 1 & 2, 1999
France	Ms. Carole Chabut, Conservateur Stagiare	ENSSIB Intern, BA Reference Services, 1997
France	M. Jean-Pierre Dumontier, Institut Européen des Affaires, Paris (IEA)	Intern, Internet, 1997
France	M. Jean Michel, President CEBS	First international Symposium (Collection Development, 1994)
France	Ms Valerie Tesniere, BNF	First international Symposium (Collection Development, 1994)
France	Dr. Mohammed Hassoun	ENSSIB, Training for DDC, 1995

Country/Entity	Name	Field
France	M. Jean-Pierre Corteggiani, Institut Français d'Archéologie, Cairo	Second international Symposium (Collection Development, 1995)
France	M. François Dupuisgrenet Derousilles, Director, ENSSIB	ISIS, 1996
France	M.F.G. Barbier-Wiesser, Chargé de Coopération Documentaire, Ministère des Affaires Etrangères, Ministère de la Coopération	1996
France	Prof. Anne Cheng, INALCO	2 nd Annual International Symposium, 1999
France	Prof. François de Polignac Chargé de recherche, CNRS Centre Louis Gernet	2 nd Annual International Symposium, 1999
France	Prof. Jean-Jacques Glassner, CNRS	2 nd Annual International Symposium, 1999
France	Prof. Jean Irigoïn, Collège de France,	1st Annual International Symposium, 1998 2 nd Annual International Symposium, 1999
France	Prof. Jean-Pierre Lefebvre, Ecole Normale Supérieure	1st Annual International Symposium, 1998 2 nd Annual International Symposium, 1999
France	Prof. Henri-Jean Martin, EPHE	2 nd Annual International Symposium, 1999
France	Prof. Houari Touati, Maître de conférences EHESS Centre de Recherche Historique	2 nd Annual International Symposium, 1999
France	Mme. Pierrette Turlais, Editions Artulis	2 nd Annual International Symposium, 1999
France	Prof. Jean-Yves Empereur Directeur du Centre d'Etudes Alexandrines	2 nd Annual International Symposium, 1999
France	M. Vincent Grimaud, Conseiller de Coopération et d'action culturelle, Ambassade de France	2 nd Annual International Symposium, 1999
France	M. Christian Jacob, Chargé de recherches CNRS	1st Annual International Symposium, 1998 2 nd Annual International Symposium, 1999

Country/Entity	Name	Field
France	Dr. Roland Schaer, Directeur BNF Département du développement culturel	2 nd Annual International Symposium, 1999
France	Dr. Bernard Stiegler, Université de Technologie, Compiègne	2 nd Annual International Symposium, 1999
France	Mme Véronique Chatenay-Dolto Directrice-Adjointe Ministère de la culture et de la communication	2 nd Annual International Symposium, 1999
France	Prof. Jean Ceard, Universté de la Sorbonne, Paris	2 nd Annual International Symposium, 1999
France	Prof. Viviane Alleton, Directrice de l'Ecole des hautes études en sciences sociales, Paris, Centre d'études sur la Chine moderne et contemporaine	2 nd Annual International Symposium, 1999
France	Dr. Jean-Marc Chatelain, BNF, Paris, Conservateur à la reserve des livres rares BNF, Direction des collections, François Mauriac 75706 Paris Cedex 13	2 nd Annual International Symposium, 1999
France	Prof. Jean-Pierre Drege, Directeur EFEO	2 nd Annual International Symposium, 1999
France	Dr. François Reiner, Director, Médiathèque et réseaux, Cité des Sciences DAC-Abonnement	First Annual International Symposium, 1998
France	Prof. Jean Audouze, Palais de la découverte	2 nd Annual International Symposium, 1999
France	Mr. Vincent Courtillot, Director of Research, Ministry of Education, National research and Technology	SM Planning Meetings August 1999
France	Mr. Michel Demazure, Chairman of La Cité des Sciences	SM Planning Meetings August 1999
France	Mme. Dominique Ferriot, Director of the Museum of Arts and Technology	SM Planning Meetings August 1999
France	Mr. Thierry Clavel, ENSSIB	Training on RAMEAU November 2000

Country/Entity	Name	Field
France	Prof. Henri-Jean Martin, EPHE	Book Moving Specialist 2000
France	Prof. Nicholas Grimal, Directeur de l'Institut français d'archéologie orientale, Université de la Sorbonne	First Annual International Symposium, 1998
Germany	Dr. Hans-Peter Geh, Former Director, Honorary President of International Federation of Library Associations (IFLA) Wurtemberg State & University Library	Aswan Conference, Member of IEC, First Annual International Symposium, 1998
Italy	Prof. Marchesi, Istituto per l'Arte e il Restauro, Florence	Conservation and Restoration Lab 1999
Italy	Prof. Vigano, Istituto per l'Arte e il Restauro, Florence	Conservation and Restoration Lab 1999
Italy	Prof. Lorenzo Perrone, University of Pisa	Second Annual International Symposium, 1999
Norway	Mr. H. Hoeivik	Communications, 1995
Norway	Mr. T. Hoeivik	Communications, 1995
Norway	Mr. A. Myerbakk, National Library of Norway	Conservation & Restoration, 1995, 1996
Norway	Dr. B. Rugaas- The Norwegian Agency for Development Cooperation (NORAD)	Human Resources, 1995
Norway	Dr. T. Henriksen-NORAD	Human Resources, 1995
Norway	Mr. Raymond Johansen, Director, Dept. of Information and Culture-NORAD	Front-area Furniture, 1996, 1998, 1999, 2000
Norway	Mr. Thore Hem, NORAD	Front-area Furniture, 1997, 1998, 1999, 2000
Norway	Mr. Bjorn Vagle, NORAD	Front-area Furniture, 1997, 1998, 1999
Norway	Mr. Kjetil Thorsen, President of Snohetta a.s.	Front-area Furniture, 1997, 1998, 1999, 2000

Country/Entity	Name	Field
Norway	Ms Linda Evensen, Furniture Designer, Snohetta a.s.	Front-area Furniture, 1997, 1998, 1999
Norway	Mr. Ole Gustavsen, Architect, Snohetta a.s.	Front-area Furniture, 1997, 1998, 1999
Spain	Ms Carmen Caro, Jefe del Area de Dessarrollo, Cooperacion Cultural y Relaciones, Biblioteca Nacional	First Annual International Symposium, 1998
Spain	Ms Mercedes Dexeus, Directora, Departamento de Patrimonio Bibliografico, Biblioteca Nacional	First Annual International Symposium, 1998
UNDP – Cairo	Mrs. Samia Garas	
UNDP – Cairo	Mr. Muzio, Resident Representative	
UK	Mr. H. Faulkner-Brown	Architectural Planning, 1994
UK	Dr. R. Coman, British Lib.	Architectural Planning-1994, First International Symposium (Collection Development), 1994, User Needs Analysis, 1995
UK	Mr. L. Francis, British Lib.	Architectural Planning-1994, First Symposium
UK	Mr. Ron Millen, British Lib.	First International Symposium (Collection Development), 1994; User Needs Analysis, 1995
UK	Mr. Leslie Francis, British Library	Review of Architectural Plans
UK	Prof. Herwig Maehler	First and Second International Symposium (Collection Development), 1994, 1995
UK	Mr. Alan Hopkinson, Head of Library Systems and Learning Resources, Middlesex University	IS Study, 1996; First Annual International Symposium, 1998, IS - 2000
UK	Prof. Anne Eakin Moss, Durham University	2 nd Annual International Symposium, 1999

Country/Entity	Name	Field
UNESCO	Mr. Mokhtaf M'Bow, Director-General	
UNESCO	Mr. Kochiro Matsura, Director-General of UNESCO	
UNESCO	Mr. Thomas Keller, Assistant Director-General	
UNESCO	Mr. Richard Holmquist	First International Symposium (Collection Development, 1994)
UNESCO	Mr. Giampaolo del Bigio, General Information Programme (PGI), Director of Division of Information and Informatics	CDS/ISIS, 1994, 1996
UNESCO	Mr. Wolfgang Lohner, UNESCO Representative	1995
UNESCO	Mr. Mohammed T. Miloudi, Braille Expert	Library for the Visually Impaired, 1996
UNESCO	Mr. Adnan Shehab El Din, Director UNESCO Cairo Office ROSTAS	
UNESCO	Dr. Tarek Shawki, Regional Communication and Information Advisor for Arab States	Internet, Library for the Visually Impaired, ISIS, 1998-2000
UNESCO	Dr. Ahmed Darwish, Computer Specialist	2000/2001 for IT/IS
UNESCO	Mr. Mohammed El Deek, Director UNESCO Cairo Office ROSTAS	First Annual International Symposium 1998
UNESCO	Mrs. Inas El Ebrashy, Specialist	
UNESCO Cairo Office	Mr. Amine Azzouz	First Annual International Symposium, 1998
USA	Dr. Daniel Voorstin, Library of Congress Librarian	Aswan Conference
USA	Dr. M. Aman, Dean, SLIS-UWM	ISIS, Library Affairs, Training, First Symposium, 1994, 1999

Country/Entity	Name	Field
USA	Ms Sonia Mekounian	Intern, Museums 1996
USA	Dr. Mohammed Aman, Dean and Professor at the University of Wisconsin-Milwaukee, Friends of the BA	ISIS 1986, 1994, 1999, First and Second International Symposium (Collection Development), 1994, 1995
USA	Mrs. Carmela Ruby, Librarian, California Friends of the BA	First International Symposium (Collection Development), 1994
USA	Prof. Rosalie Cuneo Amer, State Librarian of California, California Friends of the BA	First International Symposium (Collection Development), 1994
USA	Mrs. Helen Angelides, California Friends of the BA	Fund-raising, 1996
USA	Prof. William V. Jackson, New York Public Library	1996
USA	Dr. Mohammed El Zohairy, Ohio State University Libraries	Second International Symposium (Collection Development), 1995
USA	Prof. Michael J. Reiner, American University in Cairo (AUC)	First International Symposium (Collection Development), 1994
USA	Dr. Winston Tabb, Associate Librarian Library of Congress Collections Services	First Annual International Symposium, 1998
USA	Prof. Peter Bing Chair of Classics Emory University, Classics	2 nd Annual International Symposium, 1999
USA	Prof. Mary Carruthers, New York University, English	2 nd Annual International Symposium, 1999
USA	Dr. Winston Tabb, Associate Librarian, Library Services Office Collections Services, Library of Congress	First Annual International Symposium, 1998
USA	Mrs. Laila Mulgaokar, Field Director, Library of Congress	First Annual International Symposium, 1998
WHO ALDOC	Eng. Jaffar Jaffal, WHO Information Technology	First Annual International Symposium, 1998

NATIONAL SHORT-TERM CONSULTANT MISSIONS TO THE BIBLIOTHECA ALEXANDRINA

Name	Field
Prof. Dr. Mohamed Yousri Hassan, Dean, Cairo University	Tender Actions, Follow-up Committee
Prof. Dr. A. Abou El Eid, Cairo University	Tender Actions, Follow-up Committee
Prof. Dr. M. Helmy, Alexandria University	Tender Actions, Follow-up Committee
Prof. Dr. A. A. Attia, Urban Planning, Cairo University	Tender Actions, Follow-up Committee
Prof. Dr. M. El Hifni, Alexandria University, Faculty of Engineering	Tender Actions
Prof. Dr. H. Zaky, Cairo University	Tender Actions, Follow-up Committee
Prof. Dr. I. Megahed, Alexandria University	Tender Actions, Follow-up Committee
Prof. Dr. Magdi Nagui, Computer Department, Faculty of Engineering, Alexandria University	Computer Expert
Prof. Dr. Gamal Hagar, Head, History Department, Faculty of Arts, Alexandria University	Library Affairs-Acquisitions, Editor of BA Newsletter
Prof. Dr. H.Kassem, Library & Info. Science Department Cairo University	Library Affairs, Acquisitions Committee
Dr. Youssef Zeidan, Alexandria University (Damanhour Branch)	Expert on Arabic Heritage, Acquisitions Committee
Counselor S. Selim, Former VP State Council of Alexandria	Legal Affairs
Counselor Mohammed Attia, VP State Council of Alexandria	Legal Affairs

Name	Field
Counselor M. El Dakrouri, VP State Council – Cairo	Legal Affairs, Tender Actions, Follow-up Committee, IEC
Prof. Dr. M. El Hashemy, Former President of Ain Shams University	Tender Actions, Follow-up Committee
Prof. Dr. Onsi Abdel Aleem, Faculty of Engineering, Alexandria University,	Tender Actions, Follow-up Committee
Prof. Dr. M. Taher El Sadek, Alexandria University	Tender Actions, Follow-up Committee
Prof. Dr. Osama El Masry, Faculty of Engineering, Alexandria University	Tender Actions, Follow-up Committee
Dr. Noha Adly, Computer Department, Faculty of Engineering, Alexandria University	Computer Expert
Dr. Hani Ayad, Department of Architecture, Faculty of Engineering, Alexandria University,	Architectural Expert
Dr. Ali Bakr, Department of Architecture, Faculty of Engineering, Alexandria University,	Architectural Expert
Dr. Mohammed Ismail, Department of Architecture, Dean, Faculty of Engineering, Alexandria University,	Architectural Expert, computer consultant
H.E. Dr. Mamdouh El Beltagui, Minister of Tourism	Library Affairs, IEC
Prof. Dr. Fathallah El Khatib, Cairo University, former Minister, former Ambassador to UNESCO	Library Affairs, Design and Supervision Contract, Tender Actions, Follow-up Committee, IEC
Dr. Mohammed Nazih El Derini, Faculty of Engineering, Alexandria, University	Computer Expert
Dr. Mohammed Fickri, Department of Architecture, Faculty of Engineering, Alexandria University	Architectural Expert

Name	Field
Prof. Dr. Ibrahim M. Shabaka, Dean, 6 October High Institute of Technology, Faculty of Engineering	First Annual International Symposium, 1998
Prof. Dr. Abdel Sattar Abdel Hak El-Halwagui, Library Science, Faculty of Arts, Cairo University	First Annual International Symposium, 1998 Second Annual International Symposium, 1999
Prof. Dr. Mohammed El-Sherbini, Executive Manager, Information Center and Applications, Institute of Graduate Studies and Research, Alexandria University	First Annual International Symposium, 1998
Mr. Khalid Harby, Researcher, Center of Manuscripts, Faculty of Arts, Alexandria University	First Annual International Symposium, 1998
Prof. Dr. Shaaban Abdel Aziz Khalifa, Library Sciences, Faculty of Arts, Cairo University	First Annual International Symposium, 1998
Prof. Dr. Lotfi Abdel Wahab Yehya, Professor Emeritus, Classical Civilization, Faculty of Arts, Alexandria University,	First Annual International Symposium, 1998
Prof. Dr. Mohammed Abou Gabal, Computer Science Department, Faculty of Engineering, Alexandria University	First Annual International Symposium, 1998
Prof. Dr. Ahmed Nazif, Minister of Telecommunications (now Egyptian Prime Minister)	First Annual BA Symposium, 1998
Dr. Eglal Bahgat, Director, Projects and Documentation Division, IDSC	First Annual International Symposium, 1998
Prof. Dr. Ahmed Abdel Fattah, Director of Greco-Roman Museum, Alexandria, Egypt	2 nd Annual International Symposium, 1999
Prof. Dr. Mohammed Abdel Ghani, Alexandria University	2 nd Annual International Symposium, 1999

Name	Field
Prof. Dr. Magdy Abdel Hafiz, Helouan University	2 nd Annual International Symposium, 1999
Prof. Dr. Mohammed Afifi, Cairo University	2 nd Annual International Symposium, 1999
Prof. Dr. Salah Al Sarwi, Helouan University	2 nd Annual International Symposium, 1999
Dr. Omnia Amer, Cairo University	2 nd Annual International Symposium, 1999
Prof. Dr. Atef El Iraqi, Cairo University	2 nd Annual International Symposium, 1999
Dr. Magda El Nowieemy, Alexandria University	2 nd Annual International Symposium, 1999
Prof. Dr. Abdallah El-Tatawi, Cairo University	2 nd Annual International Symposium, 1999
Prof. Dr. Ahmed Etman, Cairo University	2 nd Annual International Symposium, 1999
Dr. Mostafa Hossam Eldin, Cairo University	Expert Librarian 1995-2000; 2 nd Annual International Symposium, 1999
Prof. Dr. Mohammed El Raey, Dean, Institute of Graduate Studies and Research	Acquisitions Committee, Science Museum 1999-2000
Prof. Dr. Mostafa El-Abbadi, Department of Greco-Roman Civilization Faculty of Arts, Alexandria University	History of the Ancient Library, Acquisitions Committee, Science Museum, First Annual International Symposium 1999
Prof. Dr. Ismael Sadek, Faculty of Science, Alexandria University,	Science Museum 1999-2000
Dr. Mona Haggag, Department of Archaeology, Faculty of Arts, Alexandria University	Science Museum 1999
Dr. Hisham Abdelmohsen, Civil Engineering Department, Faculty of Engineering, Alexandria University	BA Consultant Engineer, 1993-2000 – Head of CMU

Name	Field
Dr. Ali El Magdoub, Faculty of Agriculture, Alexandria University	Conservation and Preservation, 1993
Mr. Fawzi Abdel Zaher, former Secretary General of National Commission for UNESCO	Symposiums, Tender Actions, Follow-up Committee
Prof. Dr. Fathi Saleh Former Egyptian Ambassador to UNESCO	Audio-visual documentation
Prof. Dr. Raafat Radwan, IDSC	
Prof. Dr. Mohammed Abou Gabal, Head of Computer Science Department Faculty of Engineering, Alexandria University	First Annual International Symposium, 1998
Prof. Dr. Lotfi Abdel Wahab Yehya, Professor Emeritus, Classical Civilization Department, Faculty of Arts, Alexandria University	First Annual BA Symposium, 1998
Dr. Kamel Zoheiry, Chairman, Cairo Public Library	First Annual International Symposium, 1998
Mr. Khalid Harby, Researcher, Center of Manuscripts, Faculty of Arts, Alexandria University	First Annual International Symposium, 1998
Prof. Dr. Gaballa Ali Gaballa, General Secretary of Antiquities	Second Annual International Symposium, 1999
Prof. Ayman Fouad Sayyid, Director of National Library, Cairo	Second Annual International Symposium, 1999
Prof. Dr. Abdel Halim Nour El-Din, Head of the Department of Egyptology, Faculty of Archaeology, Cairo University	Second Annual International Symposium, 1999
Dr. Mona Tolba, Ain Shams University	Second Annual International Symposium, 1999
Prof. Dr. Mohammad Abdo Mahgoub, Dean, Faculty of Arts, Alexandria University	Acquisitions Committee

Name	Field
Prof. Dr. Mohammad Zaki El Ashmawi, former Vice-President, Faculty of Arts, Alexandria University	Acquisitions Committee
Prof. Dr. Mohammad Mahmoud El Serougi, Faculty of Arts, Alexandria University	Acquisitions Committee
Prof. Dr. Abdel Aziz Salam, Faculty of Arts, Alexandria University	Acquisitions Committee
Prof. Dr. Farouk Shehata, Faculty of Fine Arts, Alexandria University	Acquisitions Committee
Prof. Dr. Mohsen Bayad, Faculty of Fine Arts, Alexandria University	Acquisitions Committee
Prof. Dr. Atiya Mohammad Hussein, Faculty of Fine Arts, Alexandria University	Acquisitions Committee
Prof. Dr. Salah Sarwat, Faculty of Medicine, Alexandria University	Acquisitions Committee
Prof. Dr. Mohammad Sameer Khadir, Faculty of Medicine, Alexandria University,	Acquisitions Committee
Prof. Dr. Mohammad El Kok, Faculty of Dentistry, Alexandria University	Acquisitions Committee
Prof. Dr. Lucette Gorag Sagaan, Faculty of Dentistry, Alexandria University	Acquisitions Committee
Prof. Dr. Nawal Khalafallah, Faculty of Pharmacy, Alexandria University	Acquisitions Committee
Prof. Dr. Ismail Abdel Hamid Ismail, Faculty of Engineering, Alexandria University	Acquisitions Committee
Prof. Dr. Hamed Deraz, Faculty of Engineering, Alexandria University	Acquisitions Committee

Name	Field
Prof. Dr. Said El Dakak, Alexandria University	Acquisitions Committee
Prof. Dr. Galal Abr Ahem, Faculty of Science, Alexandria University	Acquisitions Committee
Prof. Dr. Ahmed El Biseli, Faculty of Science, Alexandria University	Acquisitions Committee
Prof. Dr. Mona Makram Ebeid, Alexandria University	Acquisitions Committee
Prof. Dr. Abir Ahem El Sakari, Faculty of Agriculture, Alexandria University	Acquisitions Committee
Prof. Dr. Ahmed Mastagir, Faculty of Agriculture, Alexandria University	Acquisitions Committee
Prof. Dr. Shaker Helmi, Alexandria University	Acquisitions Committee
Dr. Mohammed Salem, Library Department, Cairo University	Training
Prof. Dr. Mostafa Bader, Faculty of Agriculture, Alexandria University	Horticulture Consultant
Mr. Omar Fathy, Library Department, Cairo University,	Training
Dr. Hassan El Bahr Darwich, Faculty of Engineering, Alexandria University	Music Library

NATIONAL PERSONALITIES

Dr. Esmat Abdel Meguid, Secretary General of the Arab League, former Deputy Prime Minister and Foreign Minister of Egypt

Prof. Dr. Ahmed Fathy Sorour - Speaker of the Egyptian Parliament, former Minister of Education, former Chairman of the Board of GOAL

Prof. Dr. Hussein Kamel Bahaa El Din, Minister of Education, former Chairman of the IEC and GOAL,

Prof. Dr. Farid Moustafa, former President of the Alexandria University (1984-1987)

Prof. Dr. Mohamed Said Abdel-Fattah, former President of the Alexandria University (1988-1993), President of the Alexandria Friends of the Bibliotheca Alexandrina

Prof. DR. Mohamed Fathalla El Khatib, Former Egyptian Ambassador to UNESCO, Chair of the Decision Making Committee and the Follow-up Committee

H.E. Prof. Dr. Mohamed Sami Abdel-Hamid, former Egyptian Ambassador to UNESCO

H.E. Dr. Mohsen Tawfiq, former Egyptian Ambassador to UNESCO, now UNESCO Director of Special Projects

H.E. Dr. Fathy Salah - Egyptian Ambassador to UNESCO

Prof. Dr. Nemat Ahmed Fouad, prominent writer, intellectual and speaker on national issues

EGYPTIAN CONSULTANTS TO THE PROJECT

Alexandria University: Dr. Mohamed Alaa El Din El Hifni; Prof. Dr. Osama El Masry; Prof. Dr. Mahmoud Helmy; Prof. Dr. Ibrahim Magahed; Prof. Dr. Mohamed Fathi AbdRabo; Prof. Dr. Abdel Halim Suleiman; Dr. Mohamed Nazih El Derini; Prof. Dr. Magdi Nagui; Dr. Noha Adly; Prof. Dr. Mohamed Elraey; Prof. Dr. Hisham Abdelmohsen; Dr. Ali Bakr; Dr. Mohamed Fikry; Prof. Dr. Abdel Alim Onsy;

Cairo University - Prof. Dr. Mohamed Taher El Sadek; Prof. Dr. Mahmoud Yousry Hassan; Prof. Dr. Abdel Fattah Abou El Eid; Prof. Dr. Hanafy Zaky; Dr. Abdel Mohsen Brada; Prof. Dr. Galal Matawea; Prof. Dr. Mostafa Hossam Eldin; Dr. Ahmed Darwish, the late Prof. Dr. Yousef Shafic, Dr. Kamel Megahed

Ain Shams University: Prof. Dr. M. El Hashemy; Prof. Dr. Abdallah Abdel Aziz Ataya, Dr. Abdelhadi Hosni

State Council: Cairo - Counselor Mohamed El Dakrouri, Vice-President - Cairo; Dep. Alexandria Counselor El Sayed Nofal, Counselor Mohamed Attia, Vice-President in Alexandria

Ministry of Finance: Financial Auditors of GOAL and ES - Mr. M. Abdel Moneim El Sayad; Mr. Mohamed Sharnoby; Mr. Gaber M. Silit

INTERNATIONAL SUPPORTERS

British Council, Alexandria - Mrs. Amanda Burrell, Director; Mrs. Nevine Abaza, Mrs. Valerie Teague, former Director;

France - Président Jacques Chirac; Président François Mitterand (dec.); H.E. Jean-Marc Rochereau de La Sablière, Ambassador to Egypt; Mr. Jean Pierre Castella - French Consul General, Alexandria; Mr. Alain Leloup, Mr. Antoine Des Fontaines - French Cultural Center, Alexandria; National Commission to UNESCO - Ms Michelle Delaygue

Germany- H.E. Carl-Dieter Spranger, Minister-Federal Ministry of Economic Cooperation and Development; H.E. Ambassador Schilling - Cairo;

Norway - H.E. Foreign Minister Mr. Knut Wollebaek; H.E. Mrs. Aase Kleveland, former Minister of Culture; H.E. Ambassador Mette Ravn, Embassy of Norway, Cairo; Mr. Amr Naggar - Consul General, Alexandria

ROSTAS (UNESCO Cairo Office) - Mr. Adnan Shihab Eldin - Director, Mr. Mohammed El Deek (1991-1994), Mrs. Inas Ibrachie, Mr. Hani Helal, Mr. Tawfiq Bin Amara, Mr. Capalechi, and staff
IUA - Mr. Rod Hackney, President, Mr. Francois Lombard

UNDP - Mr. William H. Draper III, Director-General - New York; Cairo Resident Representatives: Mr. Selem Kassem (1989-1994), Mr. Costante Muzio (1994-1997), Mr. Osman Ali El Abazazid, acting (1997-present), Mrs. Samia Guirguis, Project Administrator and Assistant Resident Representative, and staff;

UNESCO Mr. Amadou M'Bow - former Director-General; Mr. Jacques Tocatlian; Mr. Henrikas Yushkiavitshus, Assistant Director-General; Mr. Thomas Keller, Assistant Director-General; Dr. Giovanni F. Romerio, Giovanni F." - former Bibliotheca Alexandrina Project Manager; Mr. Giampaolo Del Bigio; Mr. Wolfgang Löhner; Dr. Hassan Salem - former Liaison; Mr. Richard Holmquist - Liaison for the Project, and other staff; Mr. Philippe Quéau; Mr. Abdel Aziz Abid, Memory of the World; and staff

ORGANIZATIONS/INSTITUTIONS

The French National Library- Mr. Jean-Pierre Angremy, President

Saur Publications, Germany - Prof. Klaus Saur

University of Complutense, Madrid -

La Laguna University, Canary Islands, Spain -

Mexico - Lic. Fernando Moreno Pena, Rector Universidad de Colima

Daimler Chrysler, Mr. Josef Schliecher

National royal Patrimony, Spain, Mr. Julio de la Guardi Garcia

Universidad Computense, Madrid, Mr. Gustavo Villapaolos Salas

The J.F. Costopoulos Foundation, Athens, Mrs. Katerina Koskina

BIBLIOTHECA ALEXANDRINA - A BRIEF CHRONOLOGY

BCE

332 BCE Alexandria founded by Alexander the Great

302 Ptolemy line established by Ptolemy I Soter (367-283) and Berenice

305 Callimachus of Cyrene (305-240), father of library science - defined bibliographic data, wrote a catalogue for books classified by topic and author

295 Great Ancient Library of Alexandria and the Lighthouse were founded by Ptolemy I Soter

297 Demetrius of Phaleron began the book collections for the Ancient Library

280 Ptolemy I Soter founds a library, mother of the world's future libraries

Demetrius of Phaleron

First depository library, Septuagint translations of the Bible

283 Ptolemy II Philadelphus (308-246) and Arsinoe I/Arsinoe II

285 Zenodotus of Ephesus, first head of the library (285-270)

299 Ptolemy III Euergetes (299-221) and Berenice II

270 Apollonius Rhodius, Librarian (270-245)

244 Ptolemy IV Philopater (244-205) and Arsinoe III

210 Ptolemy V Ehiphaes (210-180) and Cleopatra I

245 Eratosthenes of Cyrene, Librarian (245-204/1) (first to measure the circumference of the Earth)

204 Aristophanes, Librarian (204/1-189/6)

189 Apollonius Eidograph, Librarian (189/6-175)

186 Ptolemy VI Philometor (186-145) and Cleopatra II

162 Ptolemy VII Neos Philopator (162-144)

182 Ptolemy VIII Euergetes II (242-116) and Cleopatra II/Cleopatra III

141 Ptolemy IX Soter II (Lathyrus) (141-81) and Cleopatra IV/Cleopatra Selene

175 Aristarchus, Librarian (175-145) (first to proclaim that the Earth revolves around the sun)

145 Kydas (Spearman), Librarian (145-116)

140 Ptolemy X Alexander (140-88) and Cleopatra Berenice

116 Ptolemy XII Theos Philopator Neos Dionysus (Auletes) (116-51) and Cleopatra V

Heron of Alexandria (fl. 62 CE) (water clock and other mechanical items)

- 64 Strabo (64 BCE to 21 CE) (first description of the Ancient Library of Alexandria)
- 63 Ptolemy XIII (63-47) and Cleopatra VII
- 59 Ptolemy XIV (59-44) and Cleopatra VII
- 69 Cleopatra VII (69-30), end of the Ptolemies
Marc Anthony
- 63 Emperor Caesar Augustus (63 BCE – 14 CE)
- 48 Caesar's fire
Emperor Tiberius (42 BCE - __)
- 30 Roman conquest of Alexandria
- CE Menelaus of Alexandria (fl. End 1st century CE)
- 127 CE Claudius Ptolemy (127-48), geographer
Plutarch (1st century CE)
- 129-199 Galen (transmitter of most Alexandrian medical knowledge))
- 215 Destructive events by Emperor Carcalla
- 272 Destructive events by Zenobia of Palmyra
- 273 Destructive events by Emperor Aurelian
- 297 Destructive events by rebellion
- 391 Emperor Theodosius (379 -395 CE) ordered destruction of all pagan idols in decree
- 415 Hypatia murdered (mathematician) – end of Alexandrian scholarship
- 642 Arab invasion
- 12th CE John Tzetzes, medieval author about the ancient Library of Alexandria
-
- 1968 First proposals for an Alexandria University Library embodying the revival idea that began with the inauguration of King Farouk University in 1942
- 1974 Idea for new library approved by University of Alexandria Executive Board
- 1985 National Preparatory Committee appointed
The University of Alexandria Executive Board agrees to donate the Shatby site for the new library
- 1986 UNESCO Director General visit to the site on 7 February and meeting with the Preparatory Committee. He agrees that UNESCO will support the project
UNESCO Executive Board votes to support the project (October)

- 1987 UNESCO feasibility studies are undertaken
First UNESCO Appeal issued 26 October after approval of the UNESCO General Conference
- 1988 **UNDP grant for US\$ 1.2 million**
Ad Hoc Expert Group meeting on the Library Competition, 21-24 March
President Mubarak lays the cornerstone for the new building on 26 June
 International Architectural Competition announced (October)
GOAL formed by Presidential Decree 523/88
 Executive Director of GOAL appointed
 UNESCO Appeal renewed by Director General, Federico Mayor
- 1989 **Snøhetta a.s. announced as first prize winner of International Architectural Competition on 25 September**
 First meeting of the GOAL Board, September
 GOAL appoints first nucleus of staff at temporary offices in Shatby
- 1990 **First Honorary International Commission meeting and Aswan Declaration raising US\$ 65 million - 12 February**
 Presidential Decree #206/1990 was enacted allocating the Selsela site officially for building the new Library on 21st April
 Seminar on the winning design at the Palestine Hotel on 3 May
 Second meeting of GOAL Board, September
 GOAL begins acquisitions for library
 GOAL begins training of librarians
 Silk Road Project – Visit of Royal Omani Ship to Alexandria
 Egyptian-UNESCO Project Agreement – 26 October
 Decree
- 1991 Site formally placed under the control of GOAL, December
 Extensive soil tests by VIBRO begin
- 1992 **Project Manager and Deputy Project Manager appointed**
ES headquarters opened; staff appointed
 First IEC meeting in Egypt, chaired by Mrs. Suzanne Mubarak on 26 April
- 1993 Archaeological investigations begin at Library site

- Design and Supervision Contracts signed 23 October, design work begins**
Seat Agreement signed between Egypt and UNESCO - 1 November
Second IEC meeting in Alexandria on 1st December
- 1994 Prequalification and International Tender Action for Phase#1
Bibliographic format designed "BIBAL"
First International symposium on the Library's intellectual contents
- 1995 Third IEC meeting in Alexandria
Contract awarded to Rodio/Trevi/Arab Contractors Joint Venture for Phase #1
(Foundations) signed on 22 April
TP1 work begins on 15 May
Norwegian decision to contribute the "Front of House" furniture for NoK 30 million
University of Colima contributes digital library materials on Mexico
Second International Symposium on the Library's intellectual contents
Prequalification for Phase #2
Conservation and Restoration Lab established
- 1996 International Tender Action for Phase#2 (Superstructure)
Contract awarded to Balfour Beatty/Arab Contractors Joint Venture on 7 December
Phase #1 completion on 31 December; Phase #2 begins
Norwegian grant for front-of-house furniture
ES publishes first Collection Development Policy
First meeting of the International Friends in Athens (24 May)
UNESCO Appeal renewed by Director General, Federico Mayor
- 1997 February - International Audio/Visual Round Table
Spanish gift of copies of the Escorial Collection of Arab scholars manuscripts in Andalusia (Spain)
BNF gift of library materials
French grant for Information System study and prototype
French grant for Information System study and prototype
Second meeting of the International Friends in London (10 September)
November – Forum for European Cooperation
Microfilm Laboratory established at the ES

- 1998 Digital Laboratory established at the ES
 Information Study and prototype delivered
 Information Study and prototype delivered
 Completion of the building superstructure
 Third meeting of the International Friends in Athens (15 September)
 Greek contribution of US\$ 200,000 and copies of antiquities artifacts
 Ferdinand de Lesseps Association contribution of Suez Canal documents and
 corresponding donation from the Suez Canal Authority (Ismailia)
 First International Symposium: the Bibliotheca Alexandrina Continuum
- 1999 Second International Symposium: the Bibliotheca Alexandrina Continuum
 ISESCO contributes to Library for the Blind
 President Demirell of Turkey visits the Library and donates 10,000 books
 April – installation of the Book Transportation System, gift from Germany
 Spanish gift of the Cordoba manuscripts
 Japanese Cultural Grant for Audio/Visual equipment for PY 50 million (US\$500,000)
 Czech Republic book donation
- 2000 Gulbekian donation (Portugal)
 Federico Wardal donation of rare books
 “Travel A Head” exhibition from Germany
 Ceremony for contribution form Ferdinand de Lesseps Association 18 April
 Protocol with Shanghai Library on 21 May
 Installation of Front of House Furniture from Norway
 German Friends (Berlin) donation from Daimler Chrysler, ABB, Deutsche Bank and Siemens
 Italy offers study scholarships to BA librarians
 14 BA librarians travel for internships to Canada, France, Germany, Spain and USA
 GTZ expert/consultants at ES and implementation of BA Internet portal with the
 cooperation of Bielefeld University
 Work on new Information System begins through cooperation with the French
 Government and a contract with EI Audiovisuel
 Valencia, Spain conference
 Antiquities Museum showcases, gift from Greece, delivered and installed

- Work with the French Government for the design and installation of the Science Museum
Order placed to Japan for Exploratorium equipment and displays
Visit from Director of Le Grand Bibliothèque de Quebec
VTLS donation for the information system
- 2001 **Phase #2 Completion of the building superstructure, 31 March (signed 7 July)**
Mrs. Suzanne Mubarak announces completion of the Project on 3 May
Move to the new building: staff, systems, books
Law #1/2001
Appointment of new Library Director General by Presidential decree 76/2001
October experimental opening to the public
- 2002 23 April Inauguration (postponed due to external political processes)
Fourth Meeting of the International Friends in Alexandria
16th October – INTERNATIONAL INAUGURATION hosted by President Mubarak
OPENING of the Library to the public
Fifth Meeting of the International Friends in Alexandria

PTOLEMAIC TREE¹

Lagos = Berenice I

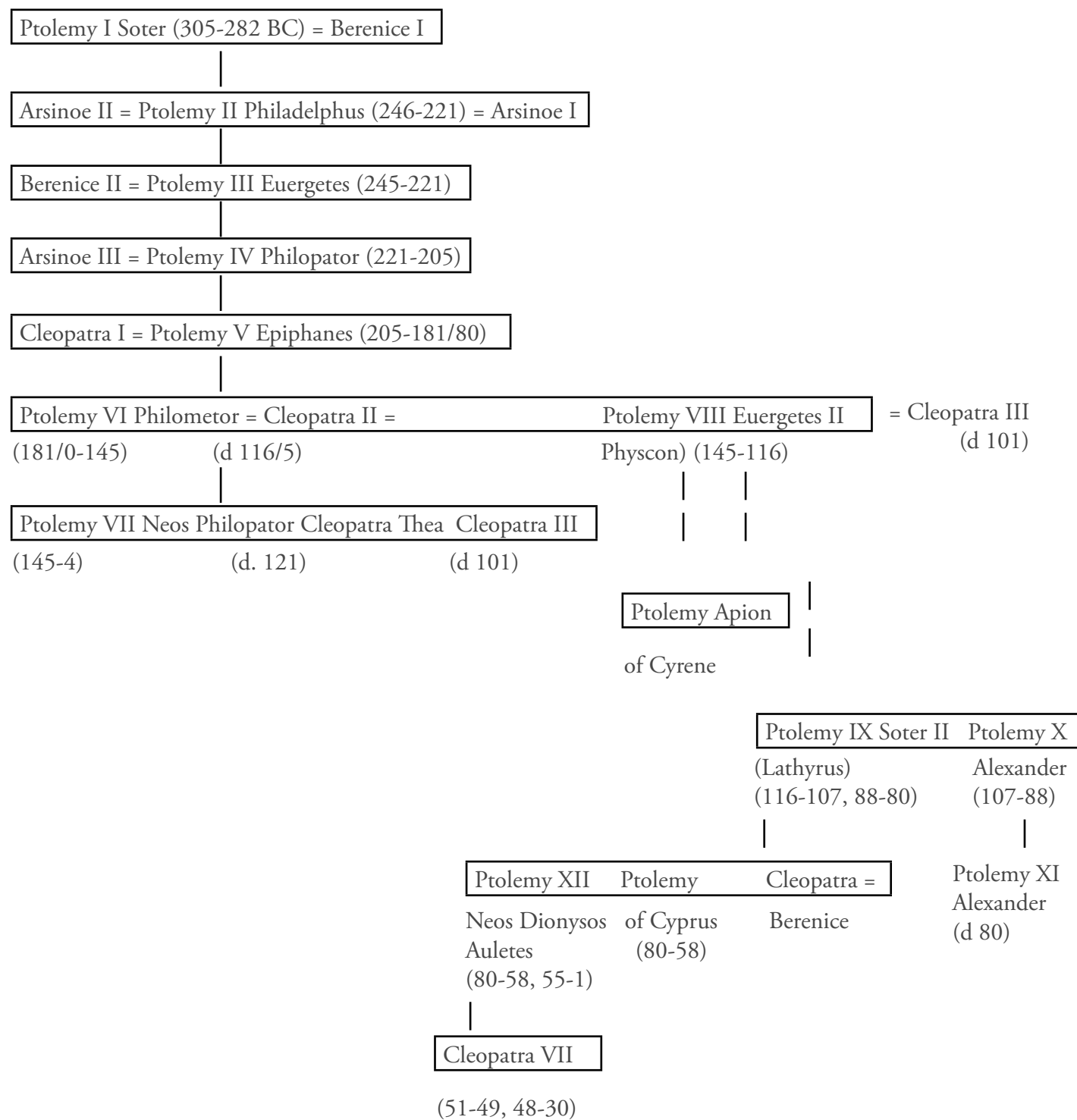

¹Grant, Michael; Cleopatra, A Biography, Barnes and Noble, 1992

ALEXANDRIA'S ANCIENT SCHOLARS

Literature

- Apollonius Rhodius 295 BC
Aristarchus of Samathrace 217-145 BC
Aristophanes of Byzantium 257-180 BC
Callimachus of Cyrene 305-240 BC
Eratosthenes of Cyrene 275-194 BC
Lycophron of Chalcis 320 BC
Manetho 280 BC
Philetas of Cos 320 BC
Strabo 64/3 BC – 21 AD
Theocritus of Syracuse 300 – 260 BC
Theon of Alexandria (grammarian) – 1st c. BC
Theon Aelius, of Alexandria (Rhetoric) – 2nd c. AD
Zenodotus of Ephesus – 325 BC

Science

- Apollodorus of Alexandria – 3rd c. BC
Apollodorus of Athens – 180 BC
Apollonius Mys – end 1st c. BC
Apollonius of Citium – 50 BC
Apollonius of Perge - 2nd half of 3rd c. BC
Archimedes – 287-212 BC
Aristarchus of Samos – 1st half of 3rd c. BC
Ctesibius – 270 BC
Diodorus of Alexandria – 1st c. BC
Diophantus of Alexandria - between 150 BC and 280 AD
Erasistratus of Ceos – 1st half of 3rd c. BC
Eratosthenes of Cyrene – 275-194 BC
Euclid (father of geometry) – 300 BC
Galen of Pergamum – 129-199 AD
Heron of Alexandria – 62 AD
Herophilus of Chalcedon – 1st half of 3rd c. BC
Hypatia (mathematician, philosopher) – d. 415 AD end of ancient scholarship in Alexandria
Menelaus of Alexandria – end 1st c. AD
Ptolemy Claudius (Claudius Ptolemaeus) (cartographer) – 127-148 AD
Strabo – 64-3 BC – 21 AD
Theon of Alexandria (mathematician and astronomer, father of Hypatia) – 364 AD

AT THE THRESHOLD OF THE THIRD MILLENNIUM

Human Civilization: Memory of Culture and Writing (from National Geographic – August 1999)

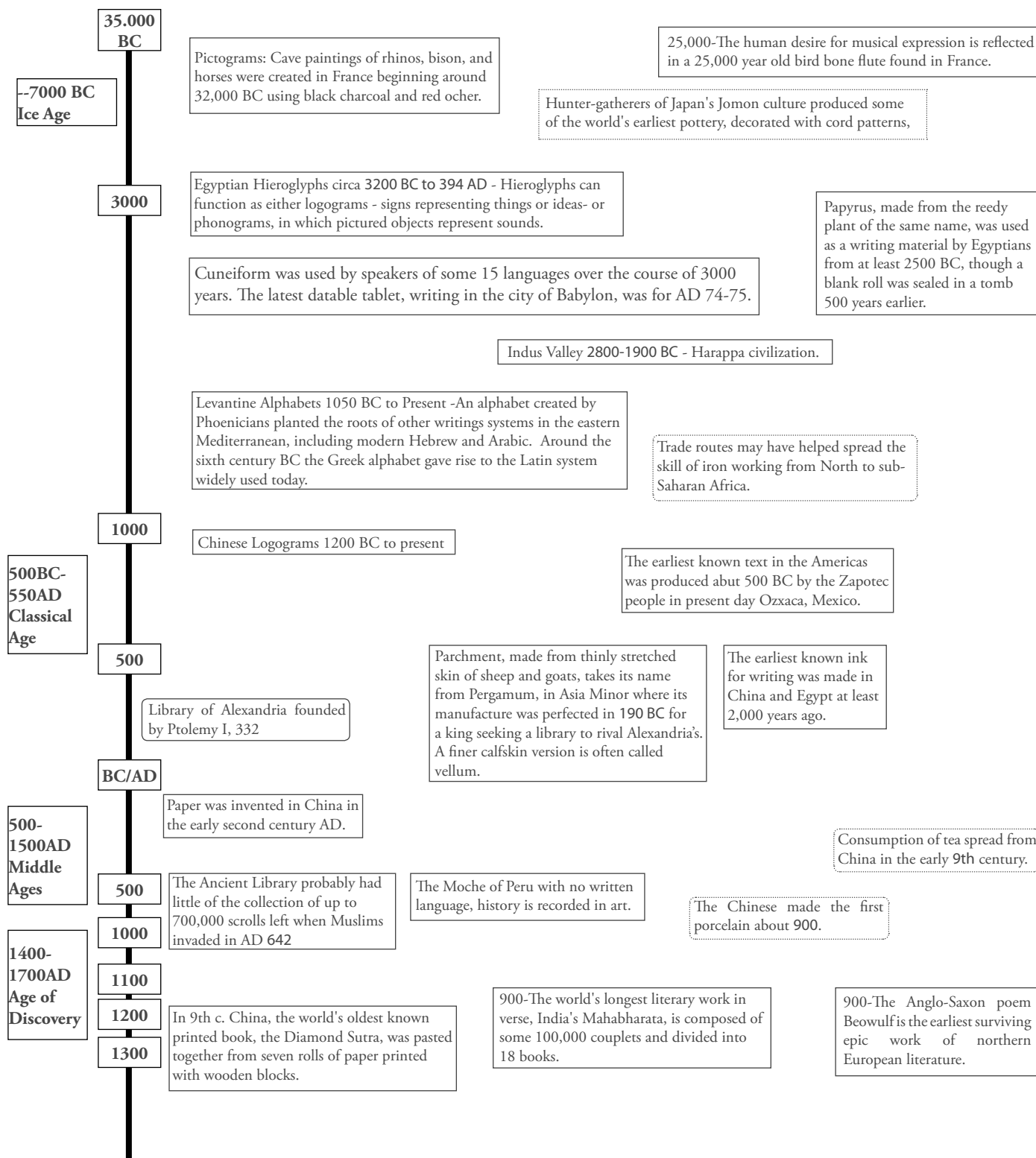

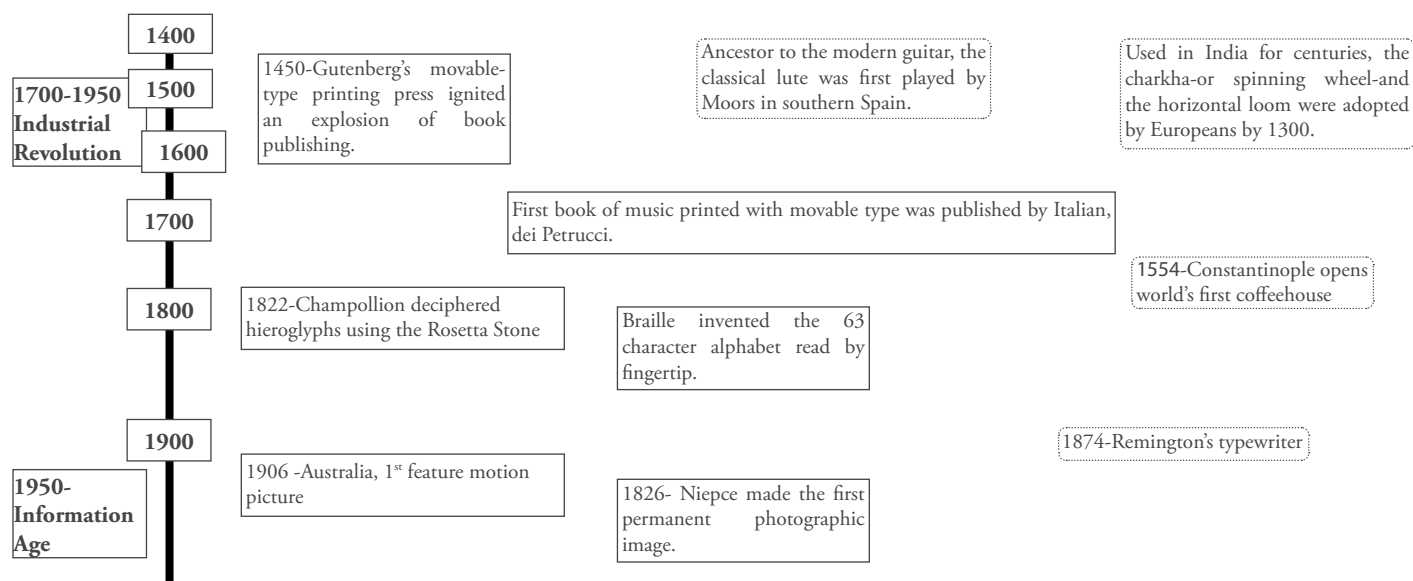

BIBLIOTHECA ALEXANDRINA
Acknowledgement of Contributions Received (up to 2001)

Aswan International Meeting, 12 February 1990 - US\$ 65 million Iraq Oman Saudi Arabia United Arab Emirates

COUNTRY/ENTITY	CONTRIBUTIONS
AGFUND ISESCO Italian FIT #1 UNESCO Cairo	US\$ 160,000 Matching funds to establish Library for the Blind
Arab Fund (Kuwait)	\$ 1 million
Arab League	Books, training
Austria	Books
Australia	<u>Wheat Board</u> - contribution of painting (A\$10,000) <u>Friends</u> : Musical composition - "The Beacon"; books
Brazil	Books
Bulgaria	CD-ROM, musical scores, books
Canada	Books, training, Bestseller library software
China	Books, Protocol with Shanghai Library
Czech Republic	Books
Egypt (governmental)	Library Site – LE 80 million Conference Center - BA building – US\$ 250 million

Egypt (Non-governmental)	<p>Books Microsoft Egypt, US\$ 364,000 (in-kind) Nile on Line, US\$ 400,000 Solutions Plus, LE 150,000 (in-kind); Delta International Bank, LE 5000 Alexandria Commercial and Maritime Bank, LE 100,000 Amreya Pharmaceutical Industry, LE 5000 Dr. Mohsen Zahran, LE 50,000, and books Al Ahram books</p>
European Union	Books (Depository Library)
Finland	Training
France	<p>Experts, Scholarships and Training, Books, Manuscripts, Design and prototype of Information System by Cap Gemini-Phase#1 (4.4millionFF), Protocol for execution of the Information System for FF 38.5 million, Science Museum - (US\$ 2 million) <u>BNF, Limoge, BPI, others</u>: book donations more than FF 1 million</p>
Germany	<p><u>GTZ</u>: Book Transportation System, Experts DM700,000 (US\$ 300,000) in 1997 <u>Saur Verlag</u>: DM 1.4 million in books; <u>ABB</u> US\$ 10,000; <u>DSE</u> books; <u>Deutsche Bank</u> DM 20,000; <u>Daimler Chrysler</u> – 2 buses (LE .5 million), library furniture (LE 120,000) and books (LE 11,000), <u>Siemens</u> Internet Café (US\$ 10,000), other support Books from various other publishers, organizations and individuals</p>

Greece	US\$ 100,000; books, sculptural pieces; Museum display cases GDms 120 million (US\$300,000): Costopolous Foundation, Ministry of Foreign Affairs, Ministry of Culture, National Bank of Greece, Greek/Egyptian Friendship League Egyptian/Greek Friends Greek Friends of the Bibliotheca Alexandrina
Honorary International Commission held at Aswan in 1990	US\$ 65 million from: <u>Iraq</u> US\$ 21 million <u>Sultanate of Oman</u> US\$ 1 million <u>Saudi Arabia</u> US\$ 20 million <u>Prince Turkey Abdel Aziz</u> US\$ 3 million <u>United Arab Emirates</u> US\$ 20 million
Italy	FIT US\$400,000: Test Conservation and Restoration Laboratory, ISIS, Automation; Books, Microfilm Laboratory FIT #2: US\$ 1 million: Manuscript Museum, Laboratory, expertise, training Wardal book donation: US\$ 315,000* Culture dei Mari: books, cultural events: exhibitions, performances,
IUA/UMAR	Protocol for depository library on Mediterranean heritage
Japan	Cultural Grant for A/V Technical Equipment: JY50 million (US\$ 500,000) Books
Jordan	Books
Mexico	<u>University of Colima</u> - 53 CD-ROMs
Norway	Support to Architects through UNESCO: US\$ 2.8 million; Front-Area Furnishings: NoK 30 million (US\$ 5 million) Training, Experts
Oman	Sultan of Oman: 6500 books and rare manuscripts

Russia	Paintings and Books
Saudi Arabia	Books
Snøhetta/Hamza Consortium	Architectural drawings of the library building (A2)
Spain	Microfilms of the Escorial Collection, Copies of Cordoba Arabic manuscripts; Copies of Catalonia Arabic manuscripts Books and other library materials
Sweden	Nobel Section; Siwa tapestry; books, Inauguration activities (Conference, exhibitions, performances)
Turkey	Expert, 10,000 books, facsimile of Quran and Sufi manuscripts
UAE	Books
UK - British Council	£ 20,000 for consultants, books, training, BBC videos Longplayer
UNDP	US\$ 1.3 million
United Nations	Books (Depository Library for all UN organizations)
UNESCO	Feasibility studies, equipment, administrative support, experts, training, Memory of BA Project, printing costs, training
USA	California Friends: US\$ 45,000 to Voluntary Contributions (UNESCO) for Computer equipment, Digital Laboratory, acquisition bibliographies California Friends: US\$ 10,000 (Rosalie Amer) VTLS library software valued at US\$ 500,000; Oracle software US\$ 153,600; Compaq hardware US\$185,000; Contributions raised by Friends/Chamber of Commerce/ AmCham (Egypt): US\$966,300 on the occasion of Mrs. Mubarak's visit to the LOC Dr. Ali Badr-Commemorative coins \$5000; Mohammed Aman, private collection of books (US\$ 10,000) Egyptian American Scholars \$10,000; Brewster Kahle \$0.5 million
Vatican	Books and facsimiles

*Gift valuation offered by donor.

NORWEGIAN GIFT OF FRONT HOUSE FURNITURE

	Number
Library Furniture	
Library chair, solid wood with leather cushion	541
Reception chair, solid wood with leather cushion & wheels	40
Study table, with computer connections	424
Meeting table	
High computer desk	80
High shelving systems	765
Low shelving systems	226
Large map case unit	16
Document cases	8
Information desks	14
Lighting	
Study desk lamp	463
Meeting table lamp	
High shelving system lighting	1798
Low shelving system lighting	530
Information desk lamp	21
Office furniture	
Chair	254
Office chair with wheels	20
Desk unit A	19
Desk unit B	15
Desk Unit C	15
Desk 1	27
Desk 2	40
Desk 3	
Desk 4	8
Console for TV/Video/CD/LP Player	24
Shelving Unit A	35
Shelving unit B	91

LIST OF BIBLIOTHECA ALEXANDRINA PUBLICATIONS (GOAL)

Golden Book, Proceedings of the first International Commission Meeting in Aswan, 1990

BA Newsletter, quarterly since 1990, in Arabic, English, and French

Rare Manuscripts. Illustrated; Text in Arabic, English, French. Bibliotheca Alexandrina: Alexandria, 1995, 45 p.

Catalog of Manuscripts in the Municipal Library of Alexandria. Part I: Sciences – Physics, Mathematics, Astronomy, Medicine; Arabic. General Organization of the Alexandria Library (GOAL): Alexandria, 1996, 286 p.

Catalog of Manuscripts in Abu'l'abbas Al Morsi Library. Part I, Arabic. General Organization of the Alexandria Library (GOAL): Alexandria, 1997, 354 p.

Quranic Manuscripts in Alexandria. Illustrated; Arabic. General Organization of the Alexandria Library (GOAL): Alexandria, 1997, 62 p.

The Dawning of the Bibliotheca Alexandrina, Arabic. General Organization of the Alexandria Library (GOAL): Alexandria, 1997. English edition, 1998

Catalog of Manuscripts in the Municipal Library of Alexandria. Part II: Sufism and Related Subjects; Arabic. General Organization of the Alexandria Library (GOAL): Alexandria, 1998, 384 p.

Proceedings of the 1st International BA Symposium 17-19 October, 1998. Catalog of Manuscripts in the Municipal Library of Alexandria. Part III: History and Related Subjects; Arabic
General Organization of the Alexandria Library (GOAL): Alexandria, 1999, 286 p.

Bibliotheca Alexandrina: Revival of the Ancient Library of Alexandria. English, In cooperation with UNESCO/UNDP, 1999. French, 1999. Reprint of the English, 2000

Catalogue of Manuscripts of Abu'l Abbas Al Morsi Library, Part II: Usul' al Fiqh and its Branches, Bibliotheca Alexandrina, 2000, 636 pp.

Governors of Alexandria Through Official Documents (1798-2000), Bibliotheca Alexandrina, 2000

“Memory of the Bibliotheca Alexandrina”, DVD, (begun in 1997, first issue 1998) with UNESCO, 2002

**COUNTRIES/PARTICIPANTS IN THE
INTERNATIONAL ARCHITECTURAL COMPETITION
(1988-1989)**

	Registrants	Final submissions
South Africa	1	0
Austria	37	0
Algeria	2	0
Saudi Arabia	2	1
Argentina	8	5
Australia	32	10
Belgium	35	12
Brazil	20	7
Bermuda	1	1
Bolivia	1	0
Bulgaria	13	10
China, Republic of	10	6
Canada	37	16
Costa Rica	2	1
Colombia	3	2
Chile	5	2
Korea, Republic of	1	5
Cyprus	3	0
Denmark	12	4
United Arab Emirates	2	1
Ethiopia	1	0
Egypt	34	21
Spain	30	10
Finland	26	14
France	217	76
Gabon	1	1
Greece	18	8
Hong Kong	13	1
Iraq	2	1
Italy	98	44

Israel	23	8
India	7	3
Ireland	8	1
Mauritius	1	0
Japan	52	16
Jordan	3	2
Jamaica	2	0
Kuwait	6	3
Luxemburg	3	2
Liechtenstein	1	0
Malaysia	4	3
Monaco	1	1
Malta	1	2
Mexico	27	9
Morocco	11	1
New Caledonia	1	0
Norway	13	5
New Zealand	7	4
Holland	30	12
Poland	16	9
Portugal	4	4
Pakistan	4	1
Qatar	2	2
Romania	1	1
Fed. Rep. of Germany	100	30
Sudan	1	0
Syria	1	0
Singapore	1	0
Sweden	27	11
Switzerland	34	10
Turkey	24	10
Tunisia	5	2
Thailand	2	0
Trinidad and Tobago	3	2
Taiwan	1	0
United States of America	66	19

United Kingdom	131	52
USSR	5	5
Uruguay	2	0
Venezuela	1	0
Yugoslavia	12	6
Czechoslovakia	6	5
Republic of Korea	7	0
Democratic Republic of Germany	<u>1</u>	1
TOTAL	1325	501

BIBLIOTHECA ALEXANDRINA BUILDING STATISTICS

Total Site Area	40,200 m ²
Total floor areas	85,405 m ²
Diameter of circular structure	160 m
Building height	33 m
Building depth below ground level	11 m
Number of floors	11
Built-up area coefficient	77%
Floor area ratio	2.13
Roof slope	16.9°
Total cost	US\$ 250,000,000

Functional Components of the Library

Main Library	36,770 m ²
Including: Books & Periodicals, Special Collections (Manuscripts and Rare Books, Multimedia Library, Maps), Young Peoples' Library, Children's Library, Taha Hussein Library for the Visually Impaired	
Study rooms	133 cubicles
Number of seats for readers	2000
Cultural Activities	4,210 m ²
Hall (Hall of Fame) – Entrance	
Science Museum/Planetarium	1,300 m ²
Exploratorium	1600 m ²
Antiquities Museum	550 m ²
Exhibition Areas and galleries	4540 m ²
Technical Services/Operational Support	10,860 m ²
Book storage area	17,000 m ²
External Plaza	8,500 m ²
Reflection Pool	4,600 m ²
Total Area of Project Components	54,565 m ²
Conference Center	4,555 m ²

TOTAL QUANTITIES OF PHASE I
(TP 1: Foundations and Ground Engineering)

ACTIVITY	Unit	Quantity	Remarks
Diaphragm Wall			
Library Diaphragm walling (excavation and concreting)	m ²	24,732.4	126 panels
Library Diaphragm walling (steel works)	ton	3,199.0	
Planetarium Diaphragm walling (Excavation and concreting)	m ²	3,363.0	28 panels
Planetarium Diaphragm walling (steel works)	ton	308.0	
Diaphragm walling (Trial panels)	m ²	640.0	3 panels
Piles			
Piling (working piles)	m	15,934.6	602 piles
Piling (steel work)	ton	2,769.0	
Piling (Trial tests)	m	131.4	5 piles
Jet grouting			
Jet grouting (__ 600)	m	7,376.9	648 columns
Jet grouting (__ 1200)	m	21,847.8	2024 columns
Jet grouting (trial test)	m	265.0	26 columns
Rock grouting	m	1323.9	63 holes
Civil works			
Prestressing operation	m	1,140.0	76 tendons
Excavation activity (Library)	m ³	254,246	
Excavation activity (Planetarium)	m ³	7,534.0	
Construction dewatering well (Library)	no.	20 wells	
Construction dewatering well (Planetarium)	no.	4 wells	
Polyethylene for drainage layer	m ²	17,656.0	
Sand for drainage layer	m ³	3,531.2	

Gravel for drainage layer	m ³	8,828.0
Blind concrete (raft foundation)	m ³	3,531.2
Horizontal HDPE (Raft foundation)	m ²	17,565.0
Vertical HDPE (Raft foundation)	m ²	6,561.0
Horizontal Voltex (Raft foundation)	m ²	17,656.0
Vertical Voltex (Raft foundation)	m ²	2,065.5
Steel installation (Raft foundation)	ton	6,035.0
Reinforced concrete (Raft foundation)	m ³	21,628.6

**TOTAL QUANTITIES OF PHASE II
(TP2/3: STRUCTURE, SERVICES, FIT-OUT AND EXTERNAL
WORKS)**

Structural Work	
Reinforced concrete for total project	80,000 m ³
Library slab shuttering	85,000 m ²
Steel reinforcement for total project	18,000 tons
Finishing Works	
Blockwork	30,800 m ²
Paint	55,000 m ²
Wood parquet	20,500 m ²
External granite flooring	6530 m ²
Internal granite flooring	2850 m ²
Stairs granite	1646 m ²
External granite flooring (Plaza)	13,148 m ²
Linoleum flooring	8,100 m ²
Epoxy flooring paint	18,700 m ²
Reflection pool ceramic tiles	4,500 m ²
Total flooring	35,364 m ²
Ceramic tiles installation	8,000 m ²
Wall cladding – Zimbabwe black granite	3,500 m ²
Wall cladding panels – wood	9,500 m ²

Wall cladding panels – metal (plastic zed)	3,150 m ²
Wall cladding panels – copper	1,232 m ²
Wall cladding panels – Stainless steel	65 m ²
Wall cladding panels – aluminum	1,464 m ²
Wall cladding panels – glazed	1,879 m ²
Pre-cast wall cladding	2,800 m ²
Total cladding panels	17,680
Partitions (various types)	34,660 m ²
Suspended ceilings installation (various)	32,400 m ²
Fire-rated doors (steel & veneer)	1,000 m ²
Balustrades	3,399 m ²
M&E Works	
Air handling Units AHU	82
Chillers and cooling towers	4
Refrigeration	650 tons
Network of insulated pipes	5,500,000 m
Smoke/Exhaust fans	39
Ducts	635 tons
Fire protection pipes	35,000 m
Fire alarm system	2500
Fire alarms (manual)	100
Water pump (1000 gal/min)	2
Spray nozzles	13,000
Fire fighting network	4,500,000 m
Plumbing, drainage and water service pipes	3,900 m
Pipe, stainless steel, for roof cleaning	750 m
MV and LV power cables	34,260 m
Dewatering wells	11
Earthing and lightning protection	1
Building Maintenance System panels	67
Security system devices	964
Speakers	2,395
CCTV Cameras	120
BMS monitors	30
Telephones – external lines	120
Telephone system – internal	800 lines

Reception antennas-VHF/UHF/Sat. dishes	5
Generators, 1500 KVA and 300 KVA	2
Fiber optic cables for Information System	8,400 m
Switch covers for Information System	30
Light fixtures	22,000
Elevators for passengers, freight	16
Electrically operated doors	145
Specialist Sub-Contractors	
Roof cladding	18,000 m ²
External wall cladding	6,000m ²
Curtain walling	5,300 m ²
Planetarium	1

THE NEW BIBLIOTHECA ALEXANDRINA

Functional and Spatial Allocation

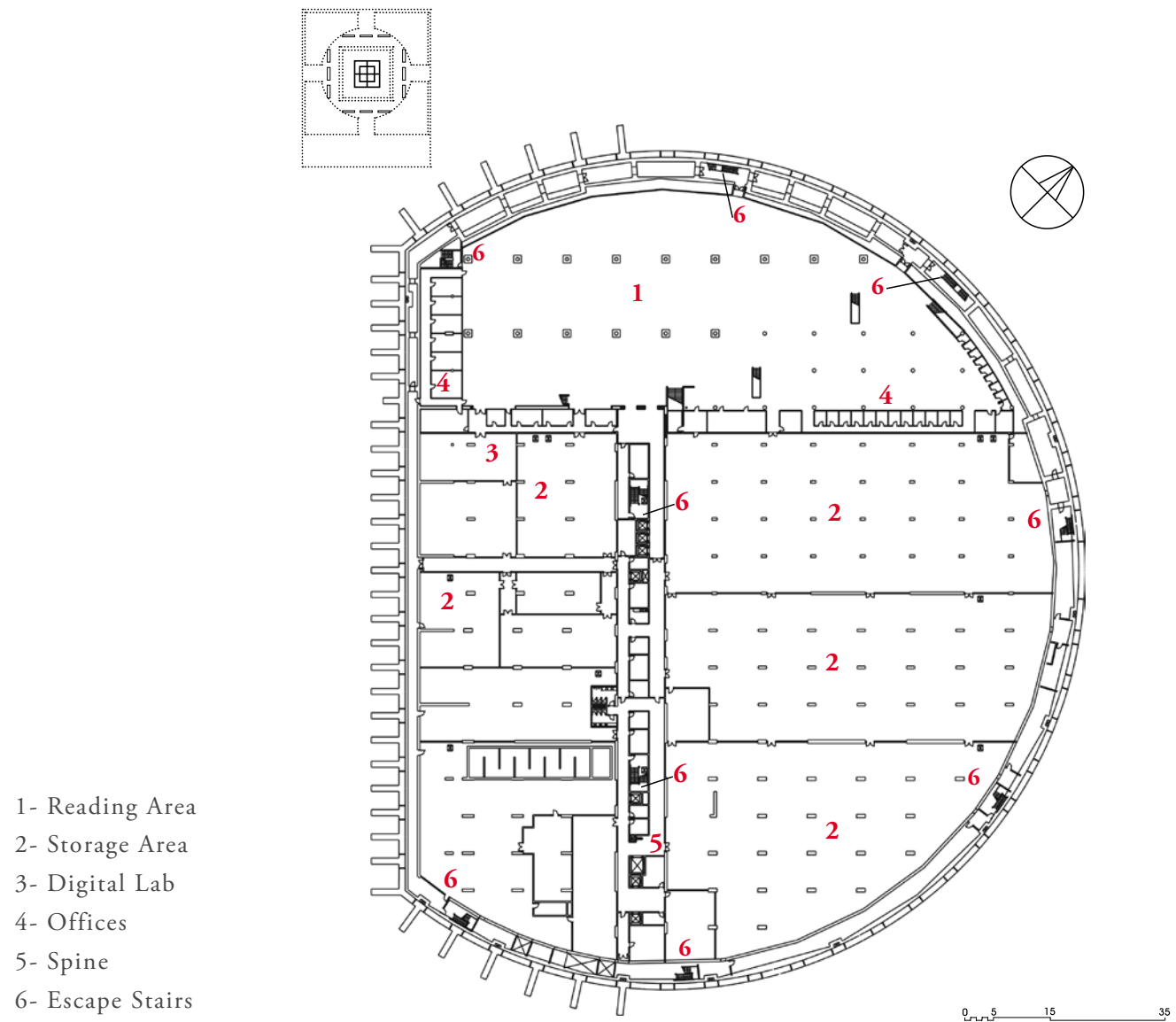

4th Basement

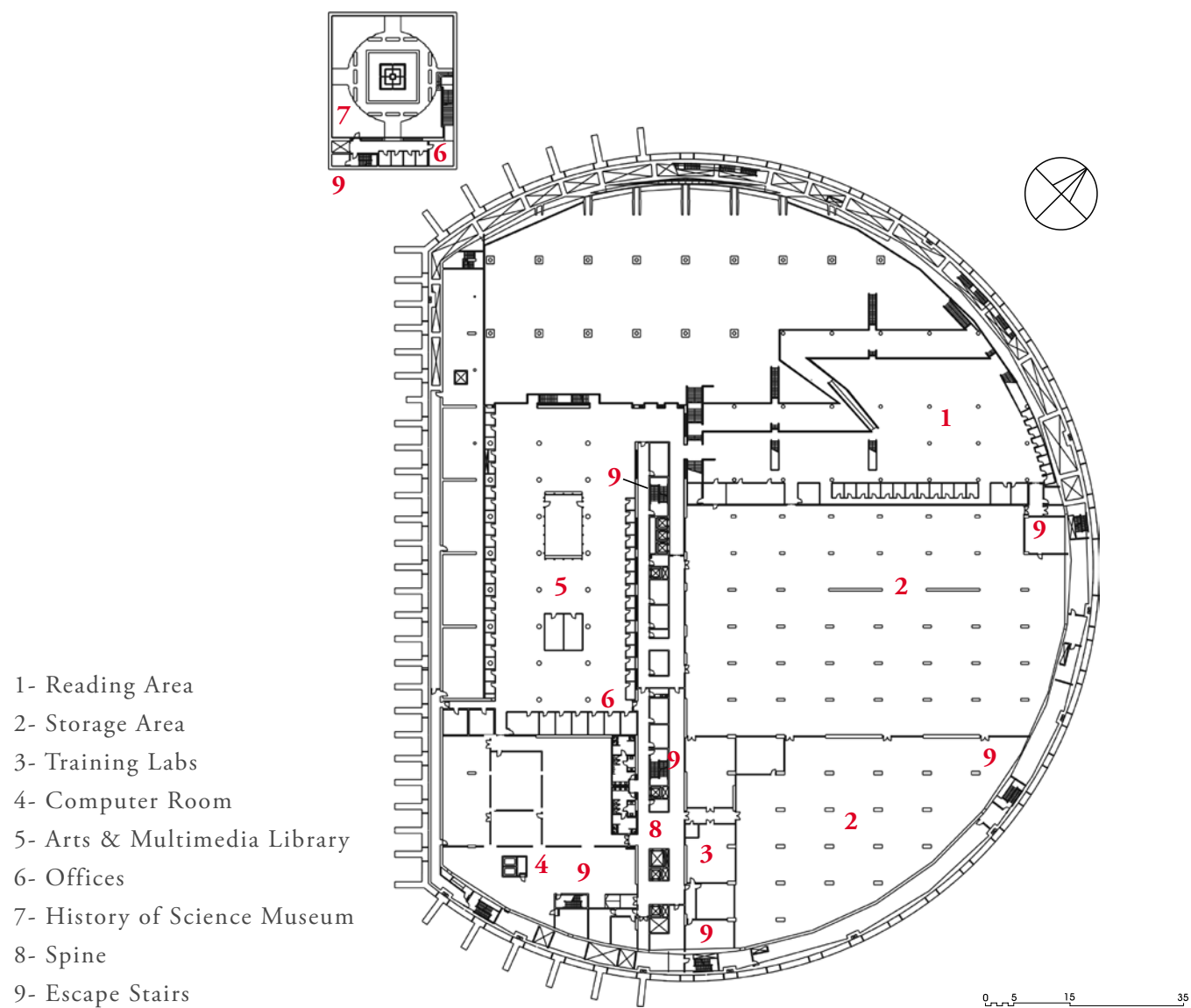

3rd Basement



2nd Basement

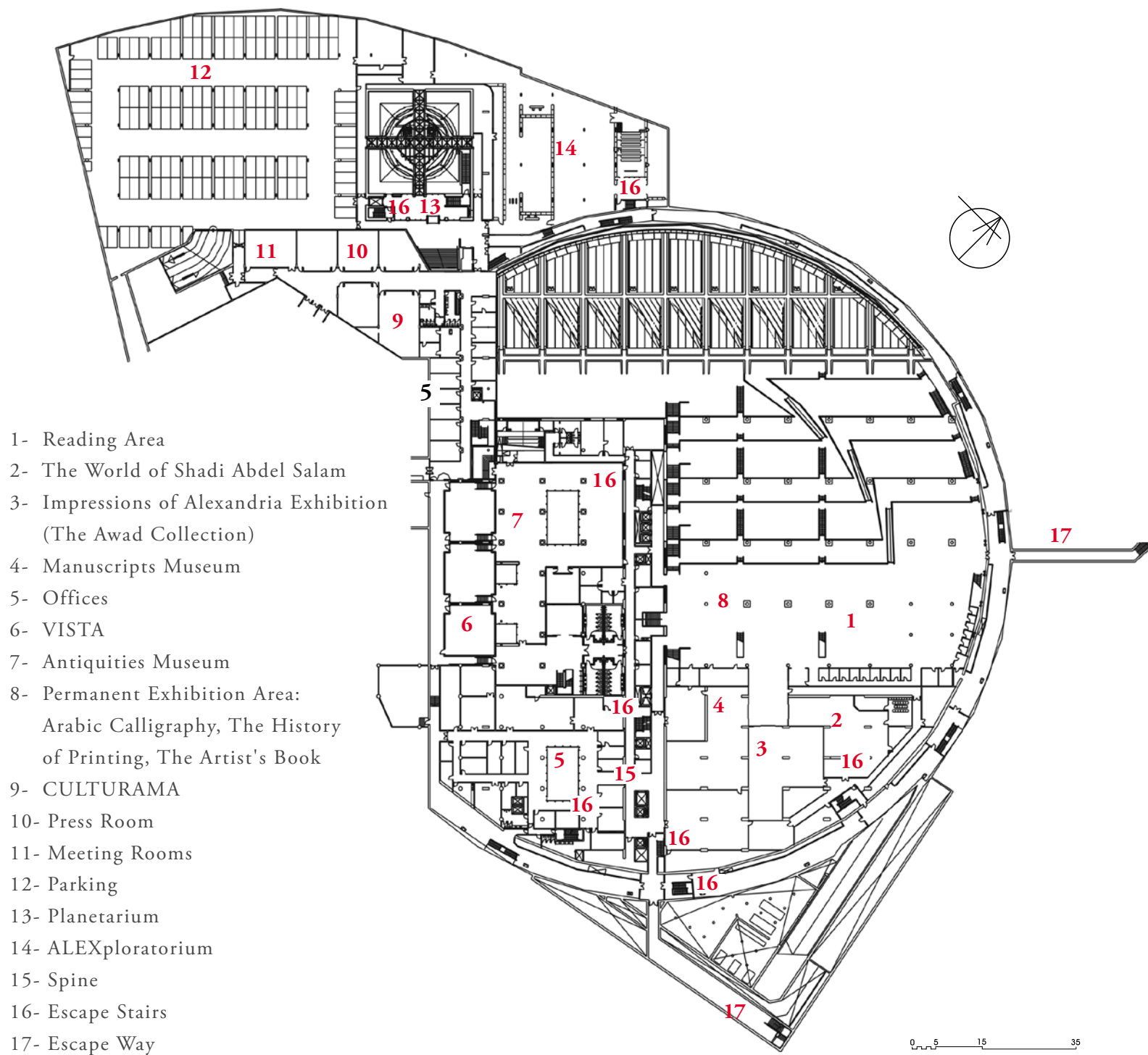

1st Basement

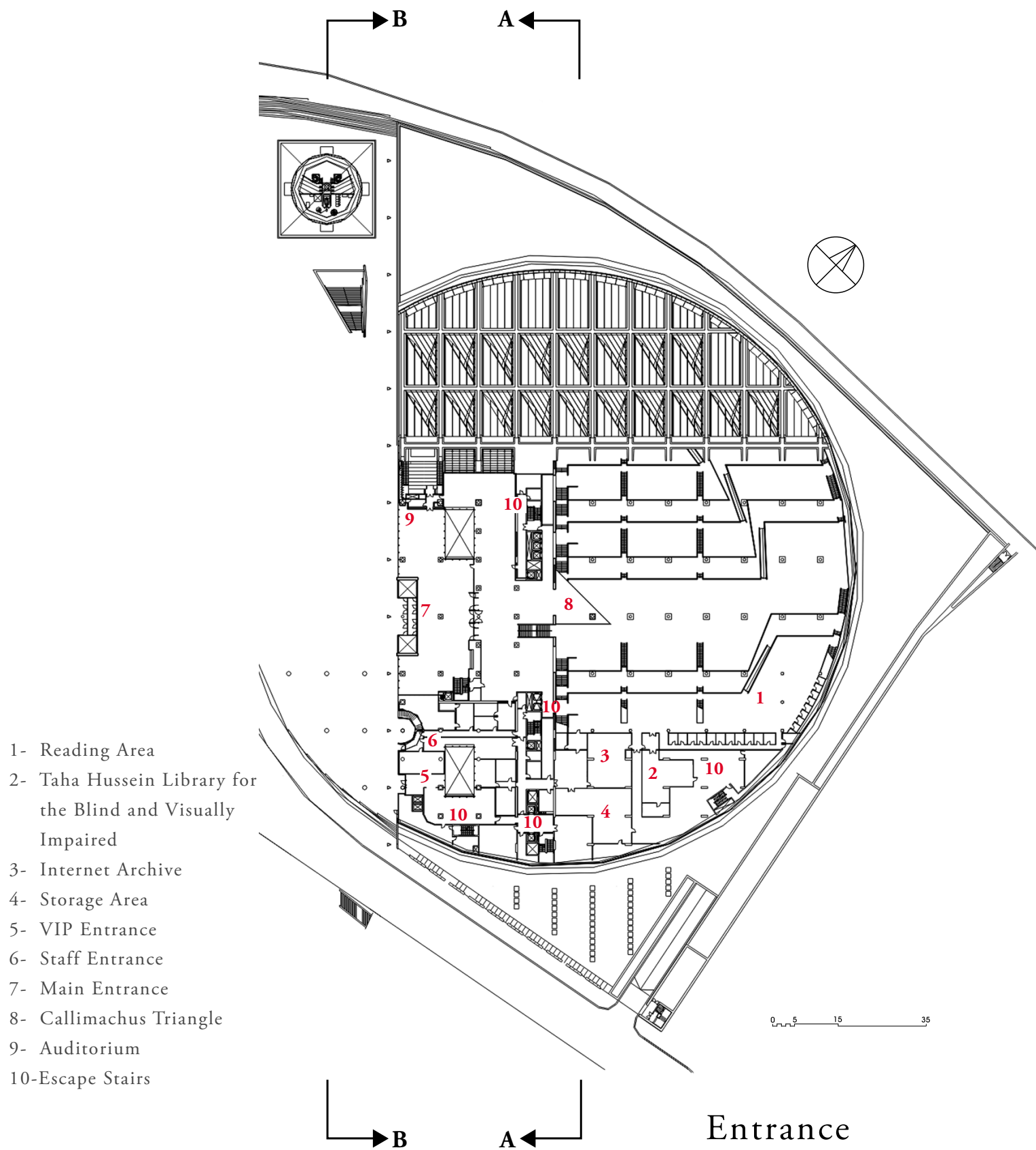

- 1- Reading Area
- 2- Taha Hussein Library for the Blind and Visually Impaired
- 3- Internet Archive
- 4- Storage Area
- 5- VIP Entrance
- 6- Staff Entrance
- 7- Main Entrance
- 8- Callimachus Triangle
- 9- Auditorium
- 10-Escape Stairs

Entrance

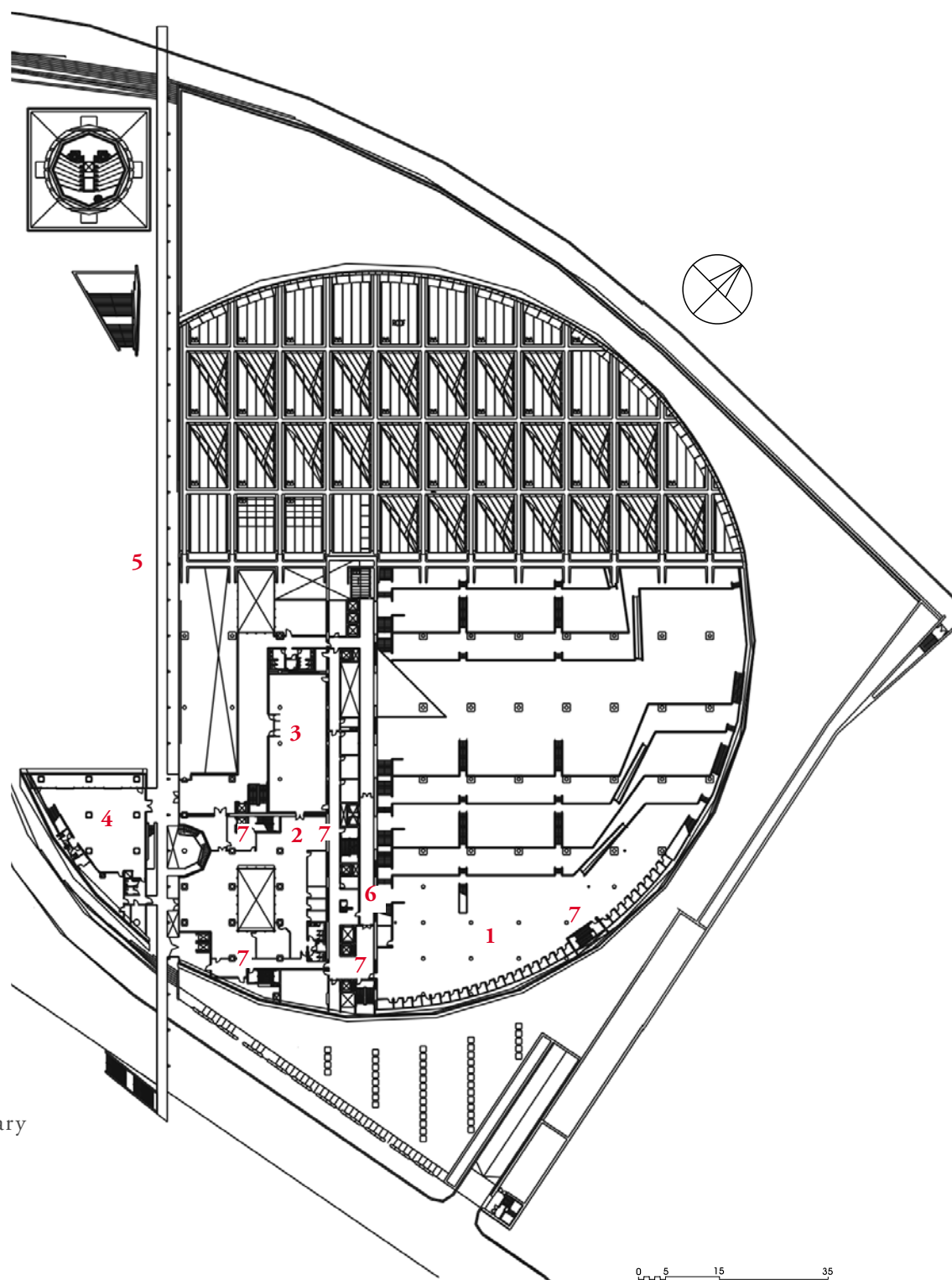

- 1- Reading Area
- 2- Children's Library
- 3- Young People's Library
- 4- Cafeteria
- 5- Bridge
- 6- Spine
- 7- Escape Stairs

1st Floor

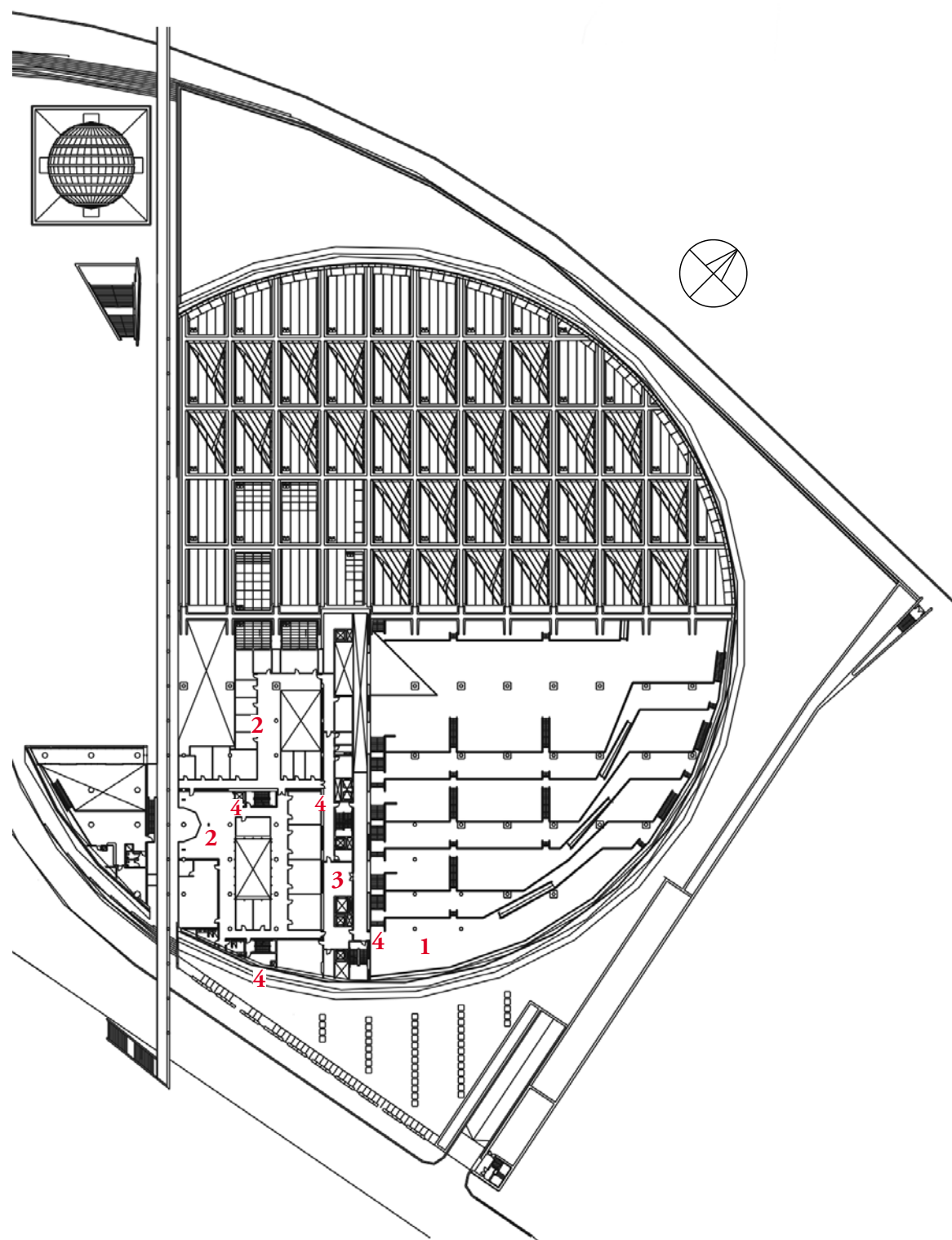

- 1- Reading Area
- 2- Offices
- 3- Spine
- 4- Escape Stairs

2nd Floor

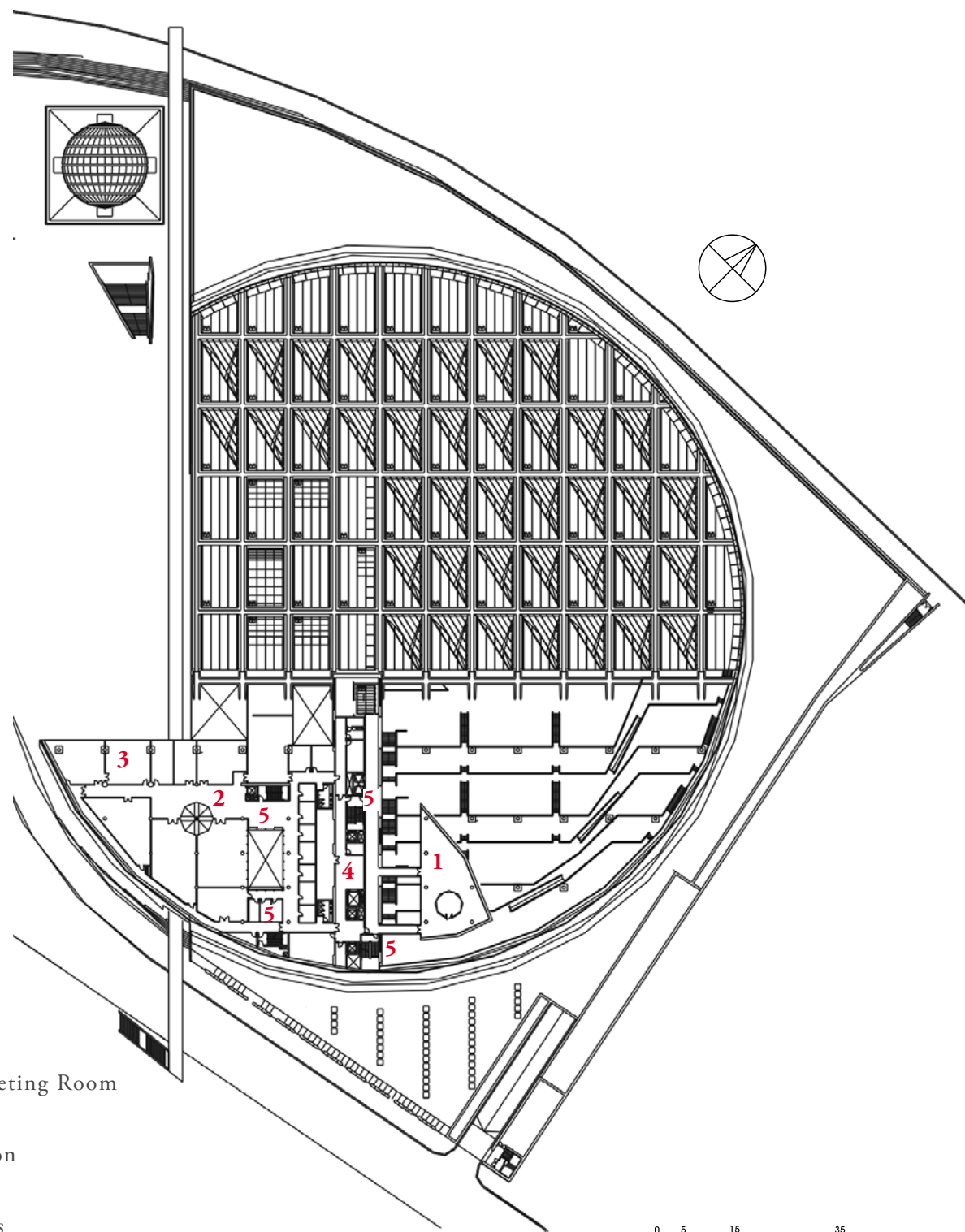

- 1- Floating Meeting Room
- 2- Offices
- 3- Nobel Section
- 4- Spine
- 5- Escape Stairs

3rd Floor

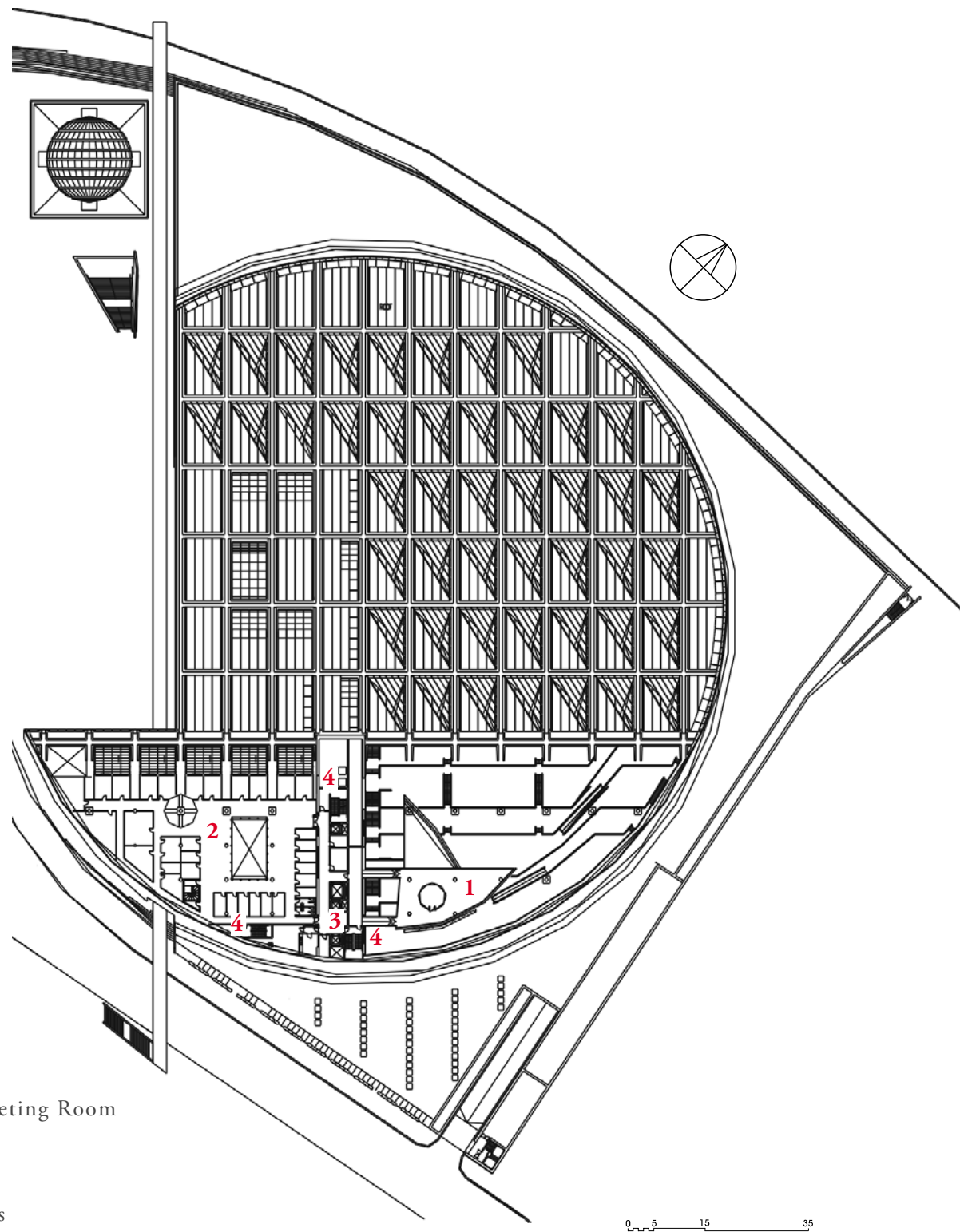

- 1- Floating Meeting Room
- 2- Offices
- 3- Spine
- 4- Escape Stairs

4th Floor

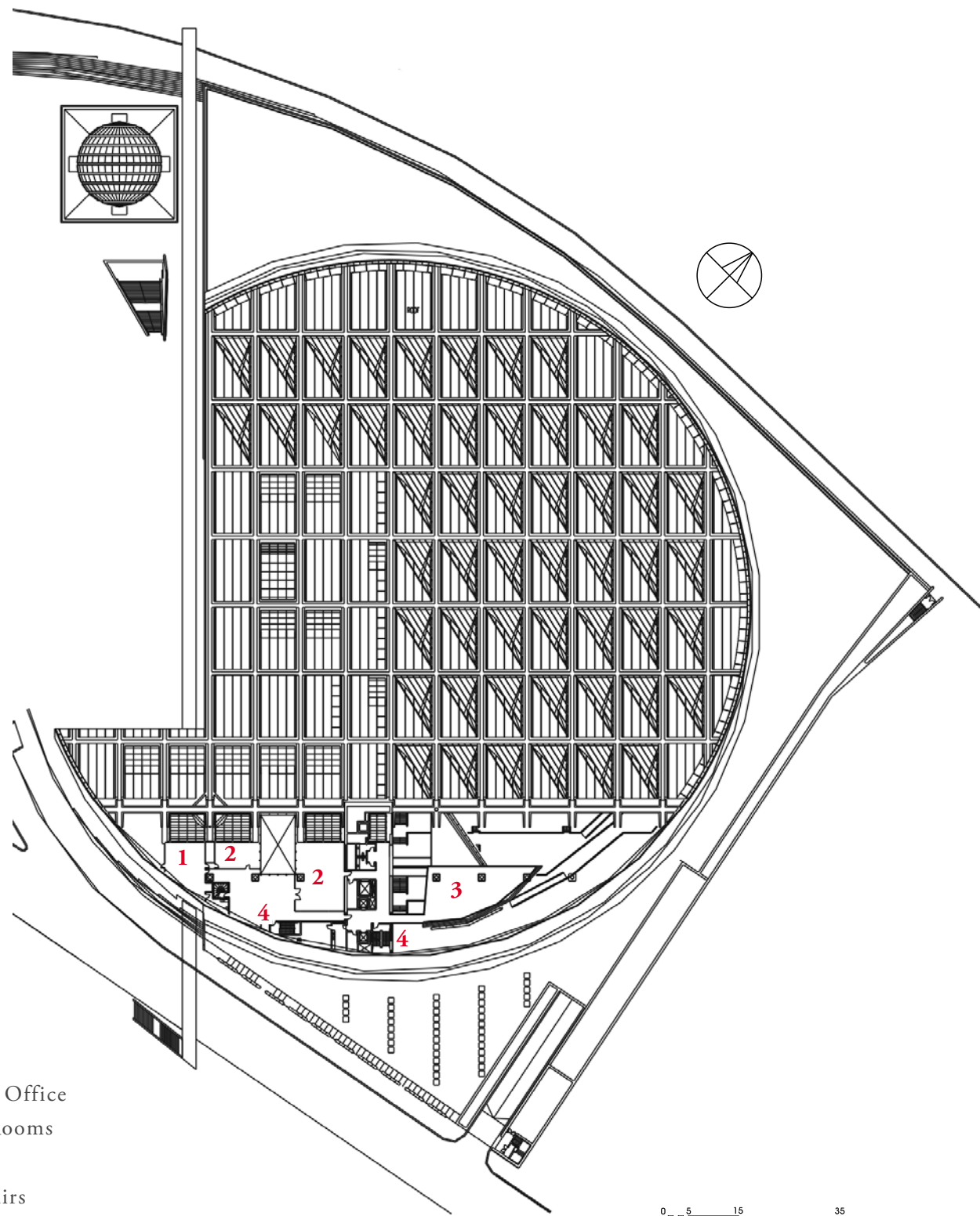

5th Floor

Massive storage space is provided beneath the cascading floors of the great Reading Hall, which is enclosed in a beautiful columned space covered by the fantastic ceiling.

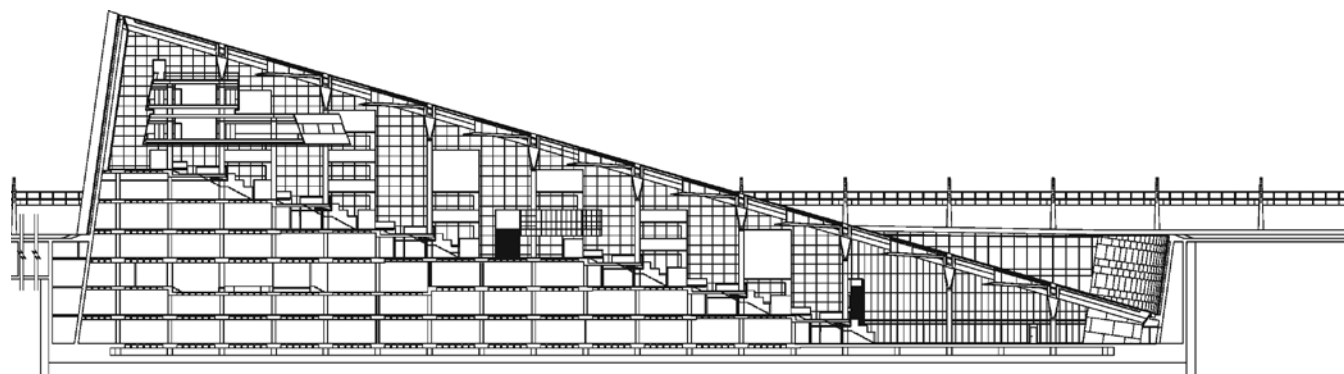

Section A-A (facing west)

The planetarium is a sphere hanging in the air by four tunnels and surrounded by the History and Science Museum. The elevation of the building in the background shows how the height is reduced by embedding four floors below ground and how the volume is reduced by the slant of the ceiling.

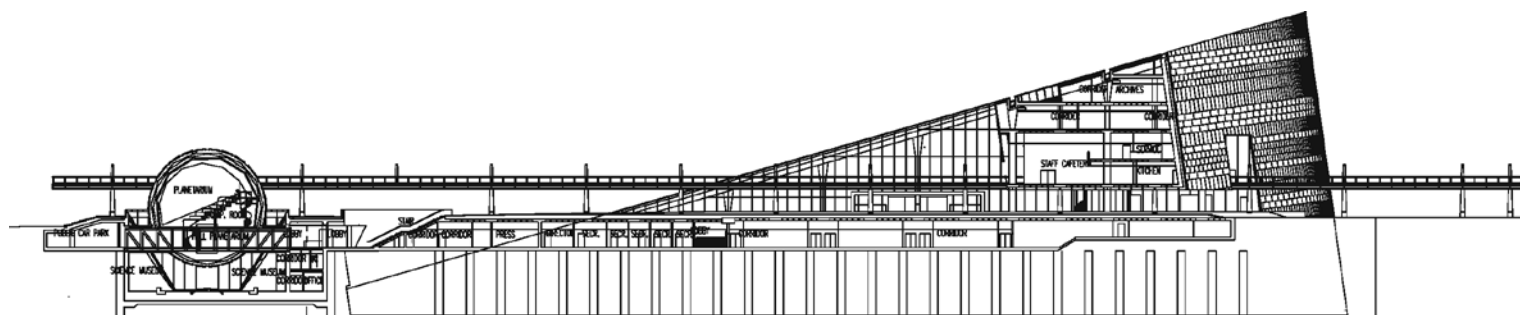

Section B-B (facing east)

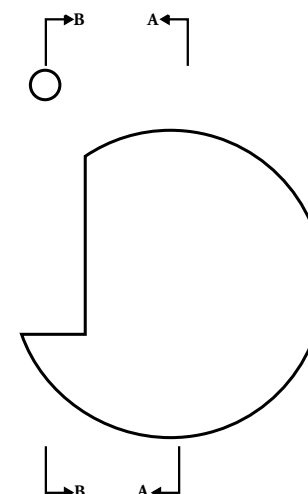

**ARAB REPUBLIC OF EGYPT PRESIDENTIAL DECREE
NO. 523 OF 1988
ESTABLISHING THE GENERAL ORGANIZATION
OF THE ALEXANDRIA LIBRARY**

The President of the Republic reviewed the Constitution:

- Law no. 61 of 1963 promulgating the Law of Public Organizations;
- Law no. 49 of 1972 concerning the Organization of the Universities;
- Law no. 53 of 1972 concerning the General Budget of the State;
- Law no. 127 of 1981 concerning the Government Accounting System;
- Law no. 139 of 1981 promulgating the Law of Education, and the Prime Minister's Decision, no. 136 of 1987 concerning the formation of a National Committee for the Revival of the Ancient Library of Alexandria,

After the approval of the Council of Ministers, And after Consulting the Council of the State, a number of decrees were issued:

Article (1)

A Public Organization entitled "The General Organization of the Alexandria Library" shall be established having an independent legal entity, with a head Office at Alexandria. It will be affiliated to the Minister of Education.

Article (2)

The aims of this Organization are the implementation and administration of the project of the Revival of the ancient Library of Alexandria with the objective of making it a universal library and a center of cultural and intellectual brilliance, in the service of scientific research. The Library will contain all the outcome of human thought, in any available form and in all languages, from the various ancient to modern civilizations. In addition, studies concerning historical, geographical and cultural foundation of Egypt and the Middle East in general, or the City of Alexandria in particular, will be important to the objectives of the Organization.

Article (3)

For achieving its aims and objectives the General Organization shall undertake all actions and tasks concerning the implementation of its activities, especially the following:

1. Acquisition of all forms and kinds of available books, periodicals, manuscripts or copies thereof, especially those relating to the scientific, cultural and intellectual heritage of the countries of the Mediterranean and Middle East regions.

2. Securing studies on the Egyptian Civilization throughout its historical époques and collecting all available papyri records and calligraphy inscriptions in different languages, e.g. ancient Egyptian, Greek, Latin, Aramaic, Coptic, Arabic.
3. Acquisition of photocopies of manuscripts in Arabic, Turkish, Hebrew, Assyrian and other oriental languages, depicting the intellectual achievements of the Islamic world.
4. Forming collections concerning African studies of all kinds and forms that include traditional African carving, contemporary scientific studies and current affairs of the African continent.
5. Acquisition of all studies concerning world history, especially the history of the Middle East.
6. Acquisition of all studies concerning the history of Medicine and other Sciences, especially the achievements of modern science and technology.
7. Establishment of the International Institute of Information Studies and/or other institutes or studies and research centers.
8. Establishment of a planetarium; a calligraphy museum showing the history, methods, tools and techniques of writing; and music halls.
9. Establishment of music libraries for discs, cassettes, films, archives for photos and slides of notable personalities and sites of interest in the region.
10. Establishing a Memorial Hall of Fame for the commemoration of eminent men of thought and achievements in science in the history of mankind.
11. Preparation of electronic networks of exchange of information with other world libraries and other leading information centers abroad.
12. Preparation of integrated computerized union catalogues on the various different fields and activities of the Organization.
13. Establishment of a Library Documentation and Statistical Unit.
14. Establishment of a modern printing press provided with orthographies of Hieroglyphic, Greek, Latin, Hebrew, Coptic, Arabic, and other languages, as well as other complete series of symbols and signs used in science and mathematics.
15. Establishment of a workshop for conservation, preservation, maintenance, repair and binding of books and manuscripts. Provision of facilities for performance of all types of photographing and photocopying services.

Article (4)

The Board of Directors of the General Organization of the Alexandria Library will be formed according to a decree issued by the Prime Minister comprising the following:

- The Minister of Education (Chairman)

The President of Alexandria University. (Vice Chairman)

and the membership of:

- The Governor of Alexandria, or his representative,
- Three professors of Alexandria University to be chosen by the University Council for a renewable three year term.
- A representative from each of the Ministries of Cultural, Information, Tourism, Higher Education and Foreign Affairs, to be chosen by the Ministers concerned,
- Not more than five notable public personalities to be selected, from distinguished men of culture and thought, by the Minister of Education for a renewable three-year term.
- The Director of the General Organization.

The Board of Directors is entitled to form committees of its members to undertake certain studies, research, tasks or other responsibilities or assignments. It may delegate some of its responsibilities to such committees.

The Board of Directors may delegate to the Director of the Organization certain defined duties.

Remuneration in compensation for the Members of the Board of Directors is to be decided by a decree by the Prime Minister.

Article (5)

The Board of Directors of the General Organization of the Alexandria Library shall have the predominant authority for conducting and running all its affairs, and deciding the policy of its operations. It is entitled to issue necessary decisions for achieving the objectives of the Organization within the framework of the general policy of the State in the domains of science, thought and the development of human values and civilization.

The Board of Directors shall have specifically the following powers and responsibilities: Issuing of the internal by-laws and rules of the Organization; and of the regulations organizing the technical, financial and administrative affairs. Financial regulations shall be promulgated after the approval of the Minister of Finance.

1. Approving of necessary plans for the execution and completion of the Revival of the Ancient Library of Alexandria Project and clearing up of all problems confronting it.
2. Adopting of the hierarchical organization and structure of grades, levels, posts and tasks and the chart of the employees.
3. Setting up the regulations concerning the employee's affairs, and determining their salaries and enumerations without adhesion to governmental rules of systems, but with, due observation of the maximum salary ceilings stipulated in the law of Civil Servants of the State.

4. Carrying out contacts with international organizations foreign countries and prominent personalities interested in the execution of the project, to invite their contributions in any way or form as expressed by them, and accepted by the Board of Directors.
5. Accepting of internal or external grants, donations, gifts, bequests, trusts and contributions which serve the objectives of the Organization, and are in agreement with approved bounds and regulations.
6. Reviewing of periodical reports on the progress of work of the Organization, and on its financial standing.
8. Approving of budget proposals and the final reports and financial statements of the Organization.
9. Carrying out of all procedures and actions necessary for running the Organization.
10. Reviewing all matters submitted by the Chairman of the Board concerning issues which are relevant to and within the jurisdiction of the Organization.
The resolutions of the Board of Directors should be submitted to the Minister of Education for ratification.

Article (6):

The University of Alexandria will offer scientific and academic support for executing the Project of the Revival of the Ancient Library of Alexandria according to the regulations approved by the Board of Directors of the Organization in concurrence with the University Council.

Article (7):

The appointment of the Executive Director of the Organization will be by Presidential Decree based on the recommendations made by the Minister of Education. The decree will contain the salaries and remunerations of the Executive Director.

The Executive Director of the Organization will be responsible for executing the policy of the Organization as set by the Board of Directors, and he will follow up the implementation of resolutions of the Board and the administration of the affairs of the Organization according to the Law and the Decree, under the supervision of the Board, and within the bounds of other responsibilities allocated to him by virtue of the regulations and rules of the Organization.

Article (8):

The financial resources of the Organization shall include:

1. The appropriations allocated by the State in the General Budget
2. National and international grants, donations, gifts, bequests, trusts and / or other contributions
3. Loans contracted for the benefit of the Organization
4. The Income received for services rendered by the Organization
5. The profits, dividends and interests gained by investing the monies of the Organization
6. Any other resources offered and given to the Organization.

Article (9):

The Organization will have a specific budget within the framework of the General Budget of the State. The fiscal year of the Organization will start and end on the same date as the State Fiscal Year. A special account will be opened for the Organization in the Egyptian Central Bank, or in any other commercial bank, approved by the Minister of Finance to deposit the funds of the Organization in it. Any surplus will be posted from one year to the next.

Article (10):

This decree shall be published in the Official Gazette, and shall come into force from the date of its publication.

Issued in the Presidency on 4th day of Gamad Awwal, 1409 H.
(14th. day of December, 1988 CE),

Signature
(Hosni Mubarak)

LAW NO. 1 FOR THE YEAR 2001

Concerning the Library of Alexandria (Bibliotheca Alexandrina)

In the name of the People

The President

The People's Assembly has enacted the following law and we have hereby issued it:

Article 1

The Library of Alexandria is a public juridical person headquartered in the city of Alexandria, attached to the President of the Republic, and it is an Egyptian center of cultural radiance, a beacon for thought, culture and science, to encompass the product of the human mind in cultures old and new in all languages.

Article 2

The Library comprises the Library, the Planetarium and the Conference Center and it is to have the following cultural and scientific institutions established within it:

1. International School for Information Studies (ISIS)
2. Center for Documentation and Research
3. Science Museum
4. Calligraphy Institute
5. Manuscript Museum
6. Center for the Preservation of Rare Books and Documents.

Other cultural or scientific institutions may be added or established by a decree of the President of the Republic and the President of the Republic shall by decree define the legal status of the institutions mentioned in this article.

Article 3

The Library shall undertake all activities that serve its mission, and undertake all actions related to so doing, by:

1. Obtaining studies, books, periodicals, manuscripts, papyri and other items that are related to the Egyptian civilization in its different ages, and related to the scientific, intellectual and cultural heritage of the countries of the world.

2. Collecting originals or copies of manuscripts that represent the intellectual achievements of the Islamic and Arab World in ancient and modern languages.
3. Collecting materials connected to the biographies and achievements of eminent figures in the realms of thought, science, politics and religion throughout human history.
4. Undertaking studies connected to the historical geographical, cultural and religious aspects of the Mediterranean region, the Middle East, Egypt and Alexandria, in particular.

Article 4

The President of the Republic shall determine by decree the manner in which the Library shall be supervised and administered, and the method in which its administrative and financial affairs shall be run, in a manner appropriate with the nature of its activities to enable it to achieve its mission, and this without being constrained by the administrative regulations stated in any other law.

Article 5

The resources of the Library shall comprise:

1. The allocations provided for it by the State
2. The support, gifts, donations, bequests, and financial contributions from internal or external sources.
3. The loans that will be secured for its benefit.
4. The income it shall receive for its services and the returns on the invested funds.
5. Any other sources that may be legally allocated to the Library.

Article 6

The Library shall have an independent budget, and its financial year shall start and end with the financial year of the Government's budget.

The Library shall have a separate account in the Central Bank of Egypt or in a commercial bank subject to the approval of the Minister of Finance.

It shall deposit in an allotted account the proceeds of its resources. The surpluses in that account shall be carried forward from one financial year to the next.

Article 7

Within the limits of its official use and requirements, the Library and its affiliated bodies shall be exempt from general taxation of its surpluses and the revenues of its current activities, and from all charges for registration and declaration, and from customs duties on its imports of scientific material.

Article 8

Presidential Decree no. 523 for 1988, establishing the General Organization for the Library of Alexandria, shall remain operative in all matters that do not contravene this Law, until the Presidential Decree mentioned in Article Four of this Law shall be enacted. Thereupon, all the assets, rights and obligations of the abolished Organization shall revert to the Library.

Article 9

This Law shall be published in the Official Journal and shall enter into force the day following its publication. Set the official seal of the State, and is to be executed as a law of the State.

Issued at the Presidency of the Republic on 17 Dhul Hijja 1421 Hijri

(12 March 2001)

Signed

(Hosni Mubarak)

PRESIDENTIAL DECREE NO. 76 FOR THE YEAR 2001

Regarding the organization of supervision of the Library of Alexandria and the manner of its management and the conduct of its financial and administrative affairs.

The President

After reviewing the Constitution and Law No.1 of 2001 concerning the Library of Alexandria, and following the agreement of the Council of Ministers, the President has decreed:

Article 1

The Library of Alexandria is a public juridical person headquartered in Alexandria and attached to the President.

Article 2

The Management of the Library of Alexandria

The Library of Alexandria shall be managed by:

- a. A council of Patrons
- b. A Board of Trustees
- c. The Director

Article 3

The Council of Patrons

The council of Patrons is composed of a number of prominent figures from different parts of the world, numbering not less than eight and no more than twenty-four, to be chosen by invitation of the President of the Republic, and one of these figures shall be the Director-General of UNESCO.

The President or his designate shall be the Chair of the Council of Patrons, and the Minister of Higher Education shall be the Secretary of the Council.

The Council shall have the responsibility of supporting the Library and following up on its activities and shall express its views on the direction of such activities.

The Council shall meet once every three years at the invitation of its Chair.

Article 4

The Board of Trustees

The Board of Trustees shall be composed of a number of eminent figures of scientific and intellectual standing or international experience, among Egyptians and non-Egyptians. They shall number no less than fifteen and no more than thirty; of whom five shall be ex-officio members of the Egyptian

Government, namely: the Minister of Higher Education, the Minister of Culture, the Minister of Foreign Affairs, the Governor of Alexandria and the President of the University of Alexandria. The Chairman of the Council of Patrons shall be the Chair of the Board of Trustees, and the said Chair shall choose a member of the Board to act for the Chair in case of the Chair's absence. The first board of Trustees shall be named by a Decree issued by the President of the Republic. For the non-ex-officio members of that Board, the duration of their membership shall be two years. After that period, the Board membership shall be renewed by a third every year. Other than this first Board, the non-ex-officio members of the Board shall be appointed by a decision of the Board of Trustees on nomination of one of the members. Membership shall be for three years, renewable for one additional term.

The board of Trustees is the decision-making power on the matters of the Library, and will be responsible for defining its general policies, for the administration and planning of its activities and for the establishment of its administrative and financial regulations.

The Board shall meet once a year and can hold exceptional (additional) meetings upon the invitation of its Chair or at the request of no less than half of its members.

The meeting of the Board shall be deemed legal if a majority of the members are in attendance, and decisions shall be by simple majority of those present. In case of equal votes, the side with the presiding Chair's vote will prevail.

The Board may constitute from its membership committees to which it may assign the execution of specific tasks, or the preparation of particular studies or the execution of research.

The Library shall bear the cost of travel and honoraria associated with the attendance of the Board meetings or the committees established by it.

Article 5

The Director

The Board of Trustees shall appoint the Director of the Library for a period of five years, renewable, and shall determine the Director's compensation. This appointment shall be by a decision of the Board supported by two-thirds of its attending members, and it is essential that the candidate be a person of international standing, wide culture, and managerial and technical competence.

The Director is the Chief Executive Officer of the Library, and is entrusted with the execution of the policies established by the Board of Trustees. The Director shall prepare the agenda for the Board meetings, and shall attend the meetings, but shall not vote on decisions before the Board. The Director shall be the head of the staff, and shall appoint the staff, promote them and terminate their services, in accordance with the legal statues they will serve under.

The Director shall be the legal representative of the Library before the judiciary and in its dealings with others.

Article 6

Administrative and Financial Regulations and Statues for Staff

The Director shall prepare the Administrative and Financial Regulations and Statues for Staff in a manner that is compatible with the nature of the Library's activities and that would enable it to execute its mission without being bound by other administrative statues specified in other laws, and these regulations and statues shall be submitted to the Board of Trustees for their approval.

Upon approval by the Board of Trustees, the Statues for staff shall be the legal statutes that shall govern the relationship between the Library and its staff.

Article 7

Budget and Auditors

The Library shall have an independent budget and the surplus shall be carried over from one fiscal year to the next.

Without prejudice to the supervision of the Government Accounting Office, the Board of Trustees shall appoint the external auditors and shall receive their reports.

Article 8

This Decree shall be published in the Official Journal and shall be operative from the date of its publication.

(Signed)

Hosni Mubarak

Issued at the Presidency of the Republic on 25 Dhul Hijja 1421 Hijri

(20 March 2001)

BIBLIOGRAPHY ON THE LIBRARY OF ALEXANDRIA

(Compiled by the ES Staff, Librarians, and UK Friends)

- Architectural Brief and Competition Rules, UNESCO, 1988 (French and English)
- Awad, Mohamed. 'A Note on the Alleged Destruction of the Alexandria. Library by the Arabs', *Journal of World History*, 8 (1964), 213-214.
- Architectural Review, June 1990.
- Architectural Review, June 1998.
- Awad, Mohamed. "A Note on the Alleged Destruction of the Aleandria Library by the Arabs", *Journal of world History*, 8 (1964, 213-214).
- Balsamo, Luigi. *Bibliography: History of a Tradition*, trans. William A. Pettas (Berkeley: B.M. Rosethal, 1990).
- Balsamo, Luigi. *Bibliography: History of a Tradition*, trans. William A. Pettas (Berkeley: B.M. Rosenthal, 1990).
- Baratom, Marc et Christian Jacob. *Le Pouvoir des Bibliothèques* (Paris: Albin Michel, 1996).
- Baratom, Marc et Christian Jacob. *Le Pouvoir des Bibliothèques* (Paris: Albin Michel, 1996).
- Barnes, J. 'Medicine, Experience and Logic', in J. Barnes, J. Brunschwig and M. Schofield (eds), *Science and Speculation* (Cambridge: Cambridge University Press, 1982), 24-68.
- Barnes, J. "Medicine, Experience and Logic", in J. Barnes, J. Brunschwig and M. Schofield (eds), *Science and Speculation* (Cambridge: Cambridge University Press, 1982), 24-68.
- Bell, Harold Idris. 'Hellenic Culture in Egypt', *Journal of Egyptian Archaeology*, 8 (1922), 139-155.
- Bell, Harold Idris. 'The Custody of Records in Roman Egypt', *Indian Archives*, 4 (1950), 116-125.
- Bell, Harold Idris. "Hellenic Culture in Egypt", *Journal of Egyptian Archaeology*, 8 (1922), 139-155.
- Bell, Harold Idris. "The Custody of Records in roman Egypt", *Indian Archives*, 4 (1950), 115-125.
- Bell, Harold Idris. *Cults and Creeds in Graeco-Roman Egypt* (Liverpool: Liverpool University Press, 1957).
- Bell, Harold Idris. *Cults and Creeds in Graeco-Roman Egypt* (Liverpool: Liverpool University Press, 1957).
- Bell, Harold Idris. *Egypt from Alexander the Great to the Arab Conquest: A Study in the Diffusion and*

- Decay of Hellenism*. Gregynog Lectures for 1946 (Oxford: Clarendon Press, 1948).
- Bell, Harold Idris. *Juden und Griechen im Römischen Alexandria* (Leipzig: Hinrichs, 19927).
 - Bell, Harold Idris. *Juden und Griechen im Römischen Alexandria* (Leipzig: Hinrichs, 1927).
 - Bennett, Helen T. 'Deconstructing the Monastery in Umberto Eco's *The Name of the Rose*', in Andrew MacLeish (ed.), *The Medieval Monastery* (Medieval Studies at Minnesota No. 2) (St. Cloud, Minnesota: North Star, 1988), 77-82.
 - Bevan, Edwyn. *The House of Ptolemy: A History of Egypt under the Ptolemaic Dynasty* (London: 1927; reprint Chicago: Argonaut, 1968).
 - Bing, Peter, *The Well-Read Muse. Present and past in Callimachus and the Hellenistic poets*, 1988
 - Bing, Peter: *The Well-read Muse: Present and Past in Callimachus and the Hellenistic poets* (Göttingen: Vandenhoeck & Ruprecht, 1988).
 - Bischoff, Bernhard. *Latin Palaeography: Antiquity and the Middle Ages*, trans. D.O. Cróinin and D. Ganz (Cambridge: Cambridge University Press, 1990).
 - Black, Jeremy A. and W. J. Tait. 'Archives and Libraries in the Ancient Near East', in Jack M. Sasson (ed.), *Civilizations of the Ancient Near East* (New York: Scribners, 1995), IV, 2197-2209.
 - Blanck, Horst. *Das Buch in der Antike* (München: C.H.Beck, 1991).
 - Blum, Rudolf, *Kallimachos*, 1991
 - Blum, Rudolf. *Kallimachos: The Alexandrian Library and the Origins of Bibliography*, trans. Hans H. Wellisch (Madison: University of Wisconsin Press, 1991).
 - Blum, Rudolph, *Kallimachos und die Literaturverzeichnis bei den Griechen*, Frankfurt-am-Main. buchhändlervereinigung, 1977, 360 columns.
 - Boitani, Piero. 'Chaucer's Labyrinth: Fourteenth-century Literature And Languages', *The Chaucer Review*, 17 (1983), 197-220.
 - Borges, Jorge Luis. 'The Library of Babel', in *Labyrinths: Selected Stories and Other Writings* (London: Penguin, 1962, 1964, 1970), 78-86.
 - Boyle, L. (ed.) *Medieval Latin Palaeography: A Bibliographical Introduction* (Toronto: University of Toronto Press, 1984), 203-232.
 - Breccia, Evaristo. *Alexandria ad Aegyptum: A Guide to the Ancient and Modern Town, and to its Graeco-Roman Museum* (Bergamo: Istituto Italiano d'Arti Grafiche, 1922).
 - Brink, C.O. 'Callimachus and Aristotle', *Classical Quarterly*, 40 (1946), 11-26.

- Brinkman, John A. 'Mesopotamian Chronology of the Historical Period', in A. Leo Oppenheim, *Ancient Mesopotamia: Portrait of a Dead Civilization* (Chicago: University of Chicago Press, 2nd ed. 1977), 335-348.
- Broek, R. van den. *Studies in Gnosticism and Alexandria Christianity* (Leiden: E.J. Brill, 1996).
- Brown, A.L. 'The Dramatic Synopses attributed to Aristophanes of Byzantium', *Classical Quarterly*, 37 (2), (1987), 427-421.
- Bulloch, A, E.S. Gruen, A.A. Long, and A. Stewart (eds)., *Images and Ideologies: Self-Definition in the Hellenistic World* (Berkeley: University of California Press, 1993).
- Bushnell, George H. 'The Alexandria Library', *Antiquity*, 2 (1928), 196-204.
- Butler, Alfred J. *The Arab Conquest of Egypt* (Oxford: Clarendon Press, 1902; 2nd ed. by P.M. Fraser, 1978).
- Calmer, C. 'Antike Bibliotheken', *Opuscula Archaeologica*, 3 (1944), 145-193.
- Canfora, Luciano, *The Vanished Library*, 1989
- Canfora, Luciano. *Il viaggio di Aristeia* (Roma: Laterza, 1996).
- Canfora, Luciano. *The Vanished Library: A wonder of the Ancient World*, Trans. Martin Ryle (Berkeley: University of California, 1989; London: Hutchinson Radius, 1989, Vintage, 1991).
- Carratelli, Giovanni Pugliese (ed.) *Dall' Eremo al Cenobio: La civiltà monastica in Italia dale origini all'età di Dante* [Antica Madre: collana di studi sull'Italia antica] (Milan: Schweiwiller, 1987).
- Cary, Max. *A History of the Greek World from 323 to 146 BC* (New York: Barnes and Noble, 1963).
- Case, Thomas. 'Aristotle', *Encyclopedia Britannica*, Eleventh Edition (1910), vol. I I, 501.
- Clagett, M. *Greek Science in Antiquity* (New York: Books for Library Press, rev. ed. 1963).
- Clark, John Willis. *The care of books: An Essay on the Development of Libraries and their Fittings, from the Earliest Times to the End of the Eighteenth Century* (Cambridge: Cambridge University Press, 1901, 2nd ed. 1902, reprinted Variorum, 1975).
- Coletti, Theresa. *Naming the Rose: Eco, Medieval Signs, and Modern Theory* (Ithaca: Cornell University Press, 1988).
- Couat, Auguste, *Alexandria Poetry under the First Three Ptolemies, 324-222 B.C.*, 1992
- Csapo, E. and W.J. Slater. *The Context of Ancient Drama* (Ann Arbor: University of Michigan Press, 1995).
- Cussler, Clive, *Treasure*, 1993

- Dalley, Stephanie. *Myths from Mesopotamia* (Oxford: Oxford University Press, 1989).
- Dantzig, Tobias. *The Bequest of the Greeks* (London: Allen and Unwin, 1955).
- Daszewski, W. 'The Origins of Hellenistic Hypogea in Alexandria', in M. Minas and J. Zeidler (eds), *Aspekte spätägyptischer Kultur: Festschrift für E. Winter in Aegyptiaca Treverensia*, 7(1994), 57-68.
- Davis, Harold T. *Alexandria, the Golden City* (Evanston, Ill.: Principia Press, 1957).
- Domeniconi, Antonio. *La Bibliotheca Malatestiana* (Quaderni della Biblioteca Malatestiana I, Cesena: Bibliotheca Comunale Malatestiana, 1982).
- Duby, Georges. *History of Medieval Arts, 980-1440* (1966-67 in three Vol; one vol ed, London: Weidenfeld and Nicolson, 1986).
- Duby, Georges. *The Age of the Cathedrals: Art and Society, 980-1420*, tr. E. Levieux and B. Thompson (London: Croom Helm, 1981).
- Düring, Ingemar. *Aristoteles* (Heidelberg: Winter, 1966).
- Durrell, Lawrence. *Justine* (London: Faber and Faber, 1957).
- Dzielska, Maria. *Hypatia of Alexandria* (Cambridge, Mass: Harvard University Press, 1995).
- Eco, Umberto. 'De biblioteca', in *Sette Anni di Desiderio* (Milan: Bompiani, 1983).
- Eco, Umberto. *How to Travel with a Salmon and other Essays* (London: Minerva, 1995).
- Eco, Umberto. *Postscript to the 'Name of the Rose'*, trans. W. Weaver (New York: Harcourt, 1993).
- Eco, Umberto. *The Name of the Rose, trans. William Weaver* (London: Secker and Warburg, 1984).
- Edelstein, L. 'The Interpretation of Ancient Science', in O. and L. Temkin (eds). *Ancient Medicine* (Baltimore: Johns Hopkins University Press, 1987), 431.
- Eisler, Robert. *Orpheus the Fisher: Comparative Studies in Orphic and early Christian Cult Symbolism* (London: J.M. Watkins, 1921).
- El Abbadi, Mostafa - *The Life and Fate of the Ancient Library of Alexandria* by UNESCO, 1990, translated into English, French, Arabic, Spanish (by Spain: Friends, 1994)
- Ellis, Walter. *Ptolemy of Egypt* (New York: Routledge, 1994).
- Emilsson, E.J., *Plotinus on Sense-perception: A philosophical Study*, Cambridge University Press, 1988
- Empereur, J.Y.A *Short Guide to the Graeco-Roman Museum* (Alexandria: Sarapis Publishing, 1995).

- *Encyclopedia Britannica*. 'Libraries', Ninth Edition (1882), vol. XIV. 509-51.
- Englund, Robert K. and Hans J. Nissen. *Die Lexikalischen Listen der Archaischen Texte aus Uruk* (Berlin: Ausgrabungen der Deutschen Forschungsgemeinschaft in Uruk-Warka 13, 1993).
- Englund, Robert K. *Archaic Administrative Texts from Uruk: The Early Campaigns* (Berlin: Ausgrabungen der Deutschen Forschungsgemeinschaft in Uruk-Warka 15, 1994).
- Englund, Robert K. and Jean-Pierre Grégoire. *The Proto-Cuneiform Texts from Jendet Nasr I: Copies, Transliterations and Glossary* (Berlin: Materialien zur frühen Schriftzeugnissen des Vorderen Orients, 1991).
- Evans, Joan (ed.) *The Flowering of the middle Ages* (London: Thames and Hudson, 1966).
- Fales, F.M. and J.N. Postgate. *Imperial Administrative Records, Pt. I. Palace and Temple Administration* (Helsinki: Helsinki University, 1992).
- Falkenstein, Adam. *Archaische Texte aus Uruk* (Leipzig: Ausgrabungen der Deutschen Forschungsgemeinschaft in Uruk-Warka 2, 1936).
- Festugière, A.-J. *Antioche Païenne et chrétienne, Libanius, Chrysostome et les moines de Syrie*, Bibliothèque des Écoles Françaises d'Athènes et de Rome, vol. 194 (Paris: Éditions E. de Boccard, 1959).
- Fiazzoni, Ambrogio M., "The Library Of Alexandria And The Vatican Library: Past And Future", Proceedings: First International BA Symposium: the BA Continuum, 17-19 October, 1998, Alexandria.
- Fideler, David (ed.) *Alexandria, Journal of the Western Cosmological Traditions* (Grand Rapids: Phanes Press, 1991).
- Fideler, David. *Jesus Christ, Sun of God* (Wheaton, Illinois: Quest Books/Theosophical Publishing House, 1993).
- Fideler, David. *Porphyry's Letter to his Wife Marcella*, trans. Alice Zimmern (London: George Redway, 1896; Grand Rapids: Phanes Press, 1986).
- Forster, Edward Morgan. *Alexandria: a History and a Guide* (Garden City: Doubleday, 1961; Gloucester, Mass: P. Smith, 1968; Michael Haag, (1982).
- Fortune, Dion. *The Mystical Qabalah* (London: 1935; York Beach: Samuel Weier, 1993).
- Foster, Benjamin R. *Before the Muses: An Anthology of Akkadian Literature* (Bethesda: CDL Press, 1993), 2 vols.
- Fraser, P.M. *Ptolemaic Alexandria* (Oxford: Oxford University Press, 1972), 3 vols.
- Fraser, P.M., *Ptolemaic Alexandria*, 1972

- Fraser, Peter M., *Ptolemaic Alexandria*, Clarendon Press, Oxford, 1972
- Frede, Michael. *Essays in Ancient Philosophy* (Oxford: Oxford University Press, 1987).
- Frede, Michael. *Galen: Three Treatises on the Nature of Science* (Indianapolis: 1985).
- Frede, Michael. 'The Empiricist attitude towards reason and theory', in R.J.Hankinson (ed.) *Method, Medicine and Metaphysics: studies in the Philosophy of Ancient Science* (Edmonton: Academic Printing and Publishing, 1988), 79-97.
- Gardthausen, V.E. 'Die Alexandrinische Bibliothek, ihr Vorbild, Katalog und Betrieb', *Zeitschrift des Deutschen Vereins für Buchwesen und Schriftum*, 5 (1922), 73-104.
- Geary, Patrick. *Phantoms of Remembrance: Memory and Oblivion at the End of the First Millennium* (Princeton: Princeton University Press, 1994).
- Gellrich, J.M. *The Idea of the Book in the Middle Ages: Language Theory, Mythology and Fiction* (Ithaca: Cornell University Press, 1985).
- Giangrande, Giuseppe. *Scripta Minora Alexandrina* (Amsterdam: Hakkert, 1980-1985).
- Goodenough, E.R. *An Introduction to Philo Judaeus* (New Haven: Yale University Press, 1940).
- Grant, Sir Alexander. *Ethics of Aristotle* (London: Parker, 1857).
- Green, J.R. 'Excavations at the Theatre, Nea Paphos, 1995-6', *Mediterranean Archaeology*, 9-10 (1996-97), 239-242.
- Green, J.R. 'Excavations at the Theatre, Nea Paphos, Cyprus, 1995-1996', in C. Petrie and S. Bolten (eds). *In the Field. Archaeology at the University of Sydney*, Sydney University Archaeological Methods Series No.4, (1997), 35-46.
- Green, J.R. 'From Taranto to Alexandria', in S.J. Bourke and J.-P. Descoeudres (eds). *Trade, Contact and the Movement of Peoples in the Eastern Mediterranean. Studies in Honour of J.Basil Hennessy*, in *Mediterranean Archaeology*, Suppl. 3 (Sydney, 1995), 271-274.
- Green, J.R. *Theatre in Ancient Greek Society* (London: Routledge, 1994).
- Green, Margaret W. 'The Construction and the Implementation of the Cuneiform Writing System', *Visible Languages*, 15 (4), (1981), 345-372.
- Green, Peter, *Alexander to Actium*, 1990
- Griffin, Jasper. 'The Library of our Dreams', *The American Scholar*, 65 (1), (Winter 1996), 59-70.
- Guthrie, W.K.C. *A History of Greek Philosophy* (Cambridge: Cambridge University Press, 1981), vol. VI, 'Aristotle, an Encounter'.

- Haag, M. *Alexandria* (Cairo: The American University in Cairo Press, 1993).
- Haller, Arndt. *Die Heiligtümer des Gottes Assur und der Sin-Samas-Tempel in Assur* (Berlin: Wissenschaftliche Veröffentlichungn der deutschen-Orient Gesellschaft 67, 1955).
- Hamel, Christopher de. *Scribes and Illuminators* (London: British Museum Press, 1992).
- Hamilton, J.R. *Alexander the Great* (London: Hutchinson University Library, 1973).
- Harrauer, Hermann, “Epigrammincipit auf einem Papyrus aus dem 3. JH v. Chr. P. Vindob. G 40611. Ein Vorbericht” in *American Studies in Papyrology*, vol. 23, pp. 49-53.
- Haskins, Charles H. *The Renaissance of the Twelfth Century* (New York: Meridian, 1957).
- Hessel, Alferd. *A History of Libraries*, trans. Reuben Peiss (New Brunswick, NJ: Scarecrow Press, 1955).
- Hodges, R. and J. Mitchell. *San Vincenzo Volturno: The Archaeology, Arts and Territory of an early Medieval Monastery* (Osney Mead: B.A.R., 1985).
- Hogart, R.C. *The Hymns of Orpheus* (Grand Rapids: Phanes Press, 1993).
- Holmes, Anne. ‘The Alexandrian Library’, *L ibri*, 30 (1980), 285-294.
- Hugh of St. Victor. *The Didascalicon of Hugh of St. Victor: a Medieval Guide to the Arts*, trans. J. Taylor (New York: Columbia University Press, 1961).
- Hussein, M.A. *Orgins of the Book: Egypt’s Contribution to the Development of the Book from Papyrus to Codex* (Greenwich, Conn.: New York Graphic Society, 1972).
- Hutchinson, G.O. *Hellenistic Poetry* (Oxford: Clarendon Press, 1988).
- Iamblichus. *The Exhortation to Philosophy*, trans. Thomas M. Johnson (Grand Rapids: Phanes Press, 1988).
- Irwin Raymond. *The English Library* (London: George Allen & Unwin, 1966).
- Jaeger, Werner. *Aristotle-Fundamentals of the History of his Development* (Oxford: Oxford University Press, 2 nd ed. 1962).
- James, John. ‘The Mystery of the Great Labyrinth, Chartres Cathedral’, *Studies in Comparative Religion*, 11 (2), (1977), 92-115.
- Jameson, Andrew G., “The Library of Alexandria”, *Bohemian Club Library Notes*, No. 75, Summer, 1993
- Johnson, Elmer D. and Michael H. Harris. *History of Libraries in the Western World* (Metuchen, NJ: Scarcrow Press, 1970, 3rd ed. 1976).

- Kamil, Jill. *Upper Egypt: Historical Outline and Descriptive Guide to the Ancient Site* (New York: Longman, 1983).
- Kenny, Antony. *The Aristotelian Ethics* (Oxford: Oxford University Press, 1978).
- Kenyon, F.G. *Books and Readers in Ancient Greece and Rome*. (Oxford: Clarendon Press, 1932).
- Knowles, D. (ed. and trans.) *The Monastic Constitutions of Lanfranc* (London: Nelson, 1951).
- Koster, W.J.W. (ed.) *Scholia in Aristophanem* (Groningen: Bouma, 1975).
- Landels, John G. *Engineering in the Ancient World* (London: Chatto and Windus, 1978).
- Leo, Friedrich. *Die Griechische-Römische Biographie* (Leipzig: B.G. Teubner, 1901).
- Lloyd, G.E.R. 'A Note on Erasistratus of Ceos', *Journal of Hellenic Studies*, 95 (1975), 172-175.
- Lloyd, G.E.R. *Adversaries and Authorities* (Cambridge: Cambridge University Press, 1996).
- Lloyd, G.E.R. *Sciences, Folklore and Ideology* (Cambridge: Cambridge University Press, 1982).
- Loyn, H.R. 'Libraries', in *The Middle Ages: A Concise Encyclopedia* (London: Thames and Hudson, 1989), 208-09.
- Madden, R.R., *Travels in Turkey, Egypt, Nubia and Palestine (1824-27)*, Henry Colbourn, 1829
- Maehler, H. and V.M. Strocka (eds). *Das Ptolemäische Ägypten: Akten d. internat. Symposions, 27-29 September 1976 in Berlin* (Mainz Rhine: Von Zabern, 1978).
- Mair, A.W. and G.R. Mair, *Callimachus: Hymns and Epigrams*, Harvard University Press, Cambridge, Massachusetts, 1989, 468 pp.
- Marlowe, John, *The Golden Age of Alexandria: From its Foundation by Alexander the Great in 331 BC to its Capture by the Aras in 642 AD*, Gllancz, London, 1971
- Marlowe, John. *The Golden Age of Alexandria: From its Foundation by Alexander the Great in 331 BC to its Capture by the Arabs in 642 AD* (London: Gollancz/Trinity Press, 1971).
- Marshall, D.N. *History of Libraries, Ancient and Mediaeval* (New Delhi: Oxford and IBH Publishing, 1983).
- Martin, H.J. *The History and Power Writing*, trans. Lydia G. Cochrane (1988, Chicago: University of Chicago Press, 1994).
- Matthews, W.H. *Mazes and Labyrinths: Their History and Development* (New York: Dover, 1970).
- McKenzie, Judith. 'Alexandria and the Origins of Baroque Architecture', in *Alexandria and Alexandrianism* (Malibu: J. Paul Getty Museum, 1996), 109-125.

- Mendelson, Alan, *Philo's Jewish Identity*, Scholars Press: Atlanta, 1988
- Milne, J. Grafton. *A History of Egypt under Roman Rule* (London: Methuen, 1924).
- Minio-Paluello, L. 'Artistotle', *Dictionary of Scientific Biography* (New York: Charles Scribner's Sons, 1970), vol. 1,250-281.
- Mostafa, El-Abbadi. *Life and Fate of the Ancient Library of Alexandria* (Paris: UNESCO, 2nd ed.1992).
- Mutahhari, Murtazā. *The Burning of Libraries in Iran and Alexandria*, trans. N.P. Nazareno, M. Nekoodast (Tehran: Islamic Propagation Organization, 1983).
- Nissen, Hans J. 'The Development of Writing and of Glyptic Art', in Uwe Finkbeiner and Wolfgang Röllig (eds). *Gamdat Nasr: Period or Regional Style?* (Wiesbaden: Tübinger Atlas des Vorderen Orients, Beiheft B62, 1986), 317-319.
- Nissen, Hans J. *The Early History of the Ancient Near East, 9000-2000 BC* (Chicago: University of Chicago Press, 1988).
- Norman, A.F. 'Libanius: The Teacher in an Age of Violence', in G. Fatouros and T. Krischer (eds) *Libanios* (Darmstadt: Wissenschaftliche Buchgesellschaft, 1983).
- Norman, A.F. 'The Book Trade in Fourth-Century Antioch', *Journal of Hellenic Studies*, 80 (1960), 122-126.
- Norman, A.F. 'The Library of Libanius', *Rheinisches Museum für Philologie*, 107 (1964), 158-175.
- Nutton, V. 'Museums and Medical Schools in Antiquity', *History of Education*, 4(1), (1975), 3-15.
- O'Brien, John Maxwell, *Alexander the Great: The invisible army*, Routledge, 1992
- O'Gorman, James F. *The Architecture of the Monastic Library in Italy, 1300-1600* (New York: New York University Press, 1972).
- O'Hara, James J. *True Names: Vergil and the the Alexandrian Tradition of Etymological Wordplay* (Ann Arbor: University of Michigan Press, 1996)
- O'Leary, Lacy. *How Greek Science Passed to the Arabs* (London: Routledge, 1949).
- O'Meara, Dominic, *Plotinus: An introduction to the Enneads*, Clarendon Press, 1993
- Ollé, James G. *Library History: An Examination Guidebook* (London: C. Bingley, 1979).
- Oppenheim, Leo. 'The Position of the Intellectual in Mesopotamian Society', *Daedalus*, 104 (2), 37-46.
- Oppenheim, Leo. *Ancient Mesopotamia: Portrait of a Dead Civilization* (Chicago: University of Chicago Press, 2nd ed. 1977).

- Parpola, Simo. 'Assyrian Library Record' , *Journal of Near Eastern Studies*, 42 (1983), 1-29.
- Parson, Edward Alexander, *The Alexandrina Library: Glory of the Hellenic World*, Elsever Press: London & New York, 1952
- Parsons, Edward A., *The Alexandrian Library*, 1952
- Parsons, Edward Alexander. *The Alexandrian Library: Glory of the Hellenic World: Its Rise, Antiquities and Destruction* (London: Cleaver-Hume Press/New York/ Amsterdam: Elsevier Press, 1952).
- Peremans, W. 'Bibliothek en Bibliothecarissen te Alexandrië', in Etienne van Cauwenbergh . *Schinium Lovaniense: Historische Opstellen*, Recueil de Travaux d'Histoire et de la Philologie, ser. 4, fasc. 24 (Louvain: Université de Louvain, 1961), 79-88.
- Pfeiffer, Rudolf (ed.) *Callimachus* (Oxford: Clarendon Press, 1949-1953).
- Pfeiffer, Rudolf, ed. *Callimachus*, 1949-1953
- Pfeiffer, Rudolf, *History of Classical Scholarship*, 1968
- Pfeiffer, Rudolf. *History of Classical Scholarship from the Beginnings to the End of the Hellenistic Age* (Oxford: Clarendon Press, 1968).
- Pinner, H.L. *The World of Books in Classical Antiquity* (Leiden: A.W. Sijthoff, 1948).
- Potts, Daniel T. *Mesopotamian Civilization: The Material Foundations* (London and Ithaca: Athlone and Cornell University Press, 1977).
- *Preliminary Design Review*, Snøhetta a.s., Norconsult international, and YRM International; UNESCO, 1990.
- Putnam, G.H. *Books and their Makers during the Middle Ages: A Study of the Conditions of the Production and Distribution of Literature from the Fall of the Roman Empire To the Close of the Seventeenth Century* (1896-97; New York: Hilary House, 1962), 2 vols.
- Reynolds, L.D. and N.G. Wilson, *Scribes and Scholars: A Guide to the Transmission of Greek and Latin Literature* (Oxford: Clarendon Press, 1974, 3rd ed. 1991).
- Ricci, Franco Maria - *Alexandria, The Site and the History*, 1992 by Mobil Oil Egypt
- Riche, Pierre. *Daily Life in the World of Charlemagne*, trans. Jo Ann McNamara (1973; Philadelphia: University of Pennsylvania Press, 1978).
- Rist, John M. *The Mind of Aristotle: A Study of Philosophical Growth* (Toronto: Phoenix, 1989), Supplementary Series XXV.
- Rogers, A. Robert and Kathryn McChensey, With the assistance of F. Laverne Carroll et al. *The Library in Society* (Littleton, Colo: Libraries Unlimited, 1984).

- Rose, Sir David. *Aristotle* (London: Methuen, 1966).
- Rose, Valentin. *Aristotle's Fragmenta* (Stuttgart: Teubner, 1966).
- Rowe, Alan. 'A Contribution to the Archaeology of the Weastern Desert, IV: The Great Serapaeum of Alexandria', *Bulletin of John Rylands Library*, 39(1956-57), 485-520.
- Rowe, Alan. *Discovery of the Famous Temple and Enclosure of Serapis at Alexandria* (Caire: Institute Français d'Archeologie Orientale, 1946).
- Runia, David, *Exegesis and Philosophy: Studies on Philo of Alexandria*, Variorum Reprints, 1990
- Runiciam, Steven. *The Medieval Manichee* (Cambrige: Cambridge University Press, 1969)
- Sagan, Carl, "Cosmos", Episode 1 (video)
- Schmidt, Friedrich, *Die Pianakes des Kallimachos*, 1922
- Schwinge, Ernst-Ricard. *Kunstlichkeit von Kunst: zur Geschichtlichkeit der Alexandrinischen Poesie* (Munchen: C. Beck, 1986).
- Scott, Alan, *Origin and the life of the stars: a history of an idea*, Oxford University Press, 1991
- Sievers, G. R. *Das Leban des Libanius* (Berlin: Weidmannsche Buchhandlung, 1868).
- Skiadas, Aristoxenos D.(ed.) *Kallimachos*(Darmstadt: Wissenschaftliche Buchgesellschaft, 1975)
- Smith, W.D. *The Hippocratic Tradition* (Ithaca: Cornell University Press, 1979).
- Sorjabi, R.(ed.) *Aristotle Transformed* (London: Duckwortg, 1990).
- Southern, R.W. *Scholastic Humanism and Unification of Europe* (Oxford: Blackwell, 1995).
- Staquet, J. 'César à Alexandrie: l'Incendie de la Bibliothèque', *Nova et Vetera*, 12 (1928), 157-177.
- Steen, G.L. (ed.) *Alexandria, the Site and the History* (New York: New York University Press, 1993).
- Strecker, K. 'Medieval Libraries', in *Intoduction to Medieval Latin*, trans. R.B. Palmer (Berlin: Weidmannsche, 1965), 121-126.
- Thompson, J.W *Ancient Libraries* (Berkeley: University of California Press, 1940).
- Thomson, R.M. 'Books and Learning at Gloucester Abbey in the Twelfth and Thirteenth Centuries', in J.P Carly and C.G.C. Tite (eds). *Books and Collectors, 1200-1700: Essays presented to Andrew Waston* (London: The British Library, 1997).
- Thomson, R.M. 'The Library of Bury St. Edmunds Abbey in the Eleventh and Twelfth Centuries', *Speculum*, 47 (4), (1972), 617-45.

- *Travels of Ali Bey in Morocco, Tripoli, Cyprus, Egypt, Arabia, Syria and Turkey (1803-07)*, Longman, 1816
- Trypanis, C.A., *Greek Poetry from Homer to Seferis*, 1981
- Turner, E.G. 'L'érudition alexandrine et les Papyrus', *Chronique d'Égypte*, 37 (1962), 135-152.
- Vallance, J.T. *The Lost Theory of Asclepiades of Bithynia* (Oxford: Clarendon Press, 1990).
- Veenhof, Klaas R. (ed.) *Cuneiform Archives and Libraries* (Leiden: Uitgaven van het Nederlands Historisch-Archaeologisch Instituut te Istanbul, 57,1986).
- Vleeschauwer, H.J. de. 'Afterword: The Musieon', in H.Curtis Wright. *The Oral Antecedents of Greek Librarianship* (Provo, Utah: Brigham Young university Press, 1977).
- Von Arnim, H. *Die Drei Aristotelischen Ethiken* (Wien: Akademie der Wissenschaften zu Wien, Phil-Hist. Klasse Sitzurberichte 202, Abh 2, 1924).
- von dem Knesebec, Harald Wolter. 'Zur Ausstattung und Funktion des Hauptsaaes der Bibliothek von Pergamon', *Boreas: Münstersche Beiträge zur Archäologie*, 18 (1995), 45-46.
- von Staden, H. *Herophilus: The Art of Medicine in Early Alexandria* (Cambridge: Cambridge University Press,1989).
- von Wyss, Wilhelm. 'The Libraries of Antiquity', *Living Age*, 316 (1923), 217-249.
- von Wyss, Wilhelm. *Die Bibliotheken des Altertums und ihre Aufgabe* (Zurich: Beer,1923).
- Walden, J.W.H. *The Universities of Ancient Greece* (London: Routledge, 1912).
- Wallis, R.T. *Neoplatonism* (London: Gerald Duckworth, 1972).
- Weber, Gregor. *Dichtung und höfische Gesellschaft: die Rezeption von Zeitgeschichte am Hof der ersten drei Ptolemaer* (Stuttgart: F. Steiner, 1993).
- Weitzmann, Kurt. *Late Antique and Early Christian Book Illumination* (New York: Braziller, 1977).
- Wendel, Carl 'Bibliothek', in Theodor Klauser (ed.). *Reallexikon für Antike und Christentum* (Stuttgart: Anton Hiersemann, 1954), Bd II, 231-274.
- Westermann, William Linn. *The Library of Ancient Alexandria*, Lecture given at University of Alexandria Reception Hall (Alexandria: University of Alexandria Press, 1954).
- White, Heather. *Studies in Theocritus and other Hellenistic Poets* (Amsterdam: Gieben, 1979).
- White, John Williams. *The Scholia on the Aves of Aristophanes* (Boston: Ginn, 1914).
- Winter, Bruce W. *Philo and Paul among the Sophists* (Cambridge: Cambridge University Press, 1977).

- Witty, F.J. 'The Other *Pinakes* and Reference Works of Callimachus', *Library Quarterly*, 43 (1973), 237-244.
- Wormald, F. and C.E. Wright (eds). *The English Library before 1700* (London: Athlone Press, 1958).
- Yates, Frances. *Giordano Bruno and the Hermetic Tradition* (London: Routledge and Kegan Paul, 1971).
- Yates, Frances. *Occult Philosophy in the Elizabethan Age* (London: Routledge and Kegan Paul, 1979).
- Yates, Frances. *The Rosicrucian Enlightenment* (London: Routledge and Kegan Paul, 1972).
- Zagari, Franco. *Bibliotheca Alexandrina: International Architectural Competition* (catalogue), UNESCO/UNDP Edizioni Carte Segrete, 1990. Exhibition 5-10 November, 1990.
- Zahran, Mohsen (Ed.). *Alexandria Plans, Names and Places*. Introduction. Author Dr. Khaled Haiba. Cairo: Dar El Akeeda, 2005.
- Zahran, Mohsen. *Philosophy of Design* (Arab). Alexandria: Dar El Maaraf, 1976.
- Zahran, Mohsen. *Alexandria 2005 Comprehensive Plan General Report*. Alexandria: Alexandria Planning Commission, 1984.
- Zahran, Mohsen. *College Housing: An Arena of Involvement and Conflict*. Beirut: Beirut Arab University, 1972.
- Zahran, Mohsen. *Challenges of the Urban Environment*. Beirut: Beirut Arab University, 1973.
- Zahran, Mohsen. *Validity and Illusions in Architecture*. Beirut: Beirut Arab University, 1979.
- Zeller, Edward. *Outlines of Greek Philosophy* (London: Longmans, 1885).

Web resources:

- <http://www.worldhistory.com/wiki/B/British-Library.htm>
- <http://www.shf.ac.uk/staff/newsletter/vol25no11/index.php3?name=000145>
- <http://www.mariinsky.ru/en/arch/contestants/perrault>
- <http://www.arts-programme.com/musee.php?code=318>
- <http://news2.thdo.bbc.co.uk/1/low/uk/218173.stm>
- <http://www.galinsky.com/buildings/bnf>
- www.wikipedia.org/wiki/Bibliothque_nationale
- www.mohsenzahran.com

PROJECT CREDITS

Client: Egypt, represented by the General Organization of the Alexandria Library (GOAL), Executive Director: Mohsen Zahran

Project Management: Executive Secretariat, Giovanni F. Romerio (UNESCO), Mohsen Zahran (Egypt), Project Managers

GOAL Construction Monitoring Unit (CMU)

CMU Supervisor: Hesham Abdelmohsen

Site Technical Administration: Yusri Hakim, Alaa Elkot

Competition Design Phase, 1989

Principal Architects: Craig Dykers (USA), Per Morten Josefson (Norway), Christoph Kapeller (Austria),

Øyvind Mo-Snøhetta (Norway), Kjetil Trædal Thorsen – Snøhetta (Norway)

Architects: Elain Molinar (USA)

Artists: Jorunn Sannes (Norway)

Advisors and Assistants: Adriana Baillie (Argentina), Ihab El Habbak (Egypt), Cordula Mohr-Art Historian (Germany)

Preliminary Design Review, 1990

Architects: Snøhetta (Norway: Architects: Craig Dykers (USA), Per Morten Josefson (Norway), Christoph Kapeller (Austria), Øyvind Mo (Norway), Elaine Molinar (USA), Martin Roubik (Czechoslovakia), Kjetil Trædal Thorsen (Norway)

Landscape Architects: Alf Haukeland, Kari Stensrød, Johan Østengen (Norway)

Fine Arts: Jorunn Sannes (Norway)

Engineers: Multiconsult (Norway), YRM International/Anthony Hung (UK)

Model builder: Stefan Tschavgov (Germany)

Video production: Tribun, France

Design Phase, 1994

Architects and Engineers: Snøhetta/Hamza Consortium (Norway/Egypt)

Design Management: Schumann Smith Ltd. (UK)

Architects, Snøhetta a.s.:

Principals: Craig Dykers (USA), Christoph Kapeller (Austria), Kjetil Trædal Thorsen (Norway)

Project Architects: Jon Bjørnsson (Norway), Mitchell de Jarnette (USA), Jim Dodson (USA),

Margarethe Friis (Norway), Lisbeth Funk (Sweden), Robert Greenwood (UK), Ole Gustavsen

(Norway), Geir Johnson (Norway), Finn Kleiva (Norway), Taraid Lundevall (Norway), Øyvind Mo

(Norway), Elaine Molinar (USA), Bjorn Stockstad, Marianne Saetre, Knut Tronstad (Norway)

Architects, Hamza Associates:

Architects: Mohamed Sharkas (Egypt)

Project Architects: Ashraf Abdel Kerim, Mahmoud Elhalawany, Ibrahim Elhayawan, Khaled Lotfy,

Omar Mansour, Walid Mansour, Mahmoud Metwaly (Egypt)

Landscape Architects, Snøhetta a.s.

Landscape Architects: Alf Haukeland, Kari Stensrød, Johan Østengen (Norway)
Project Landscape Architects: Ragnhild Momrak, Rainer Stange (Norway)
Artist- Fine Arts for the Stone Wall, Snøhetta a.s.
Artist: Jorunn Sannes (Norway)
Advisors: Kristian Blystad, Arne Johansen, Olaf Berggren (Norway)
Structural and Geotechnical Engineers, Hamza Associates
Principal: Mamdouh Hamza (Egypt)
Structural Engineers: Ahmed Rashed, Mashour Ghoneim (Egypt)
Mechanical Engineers: Hamza Associates
Mechanical Engineer: Nasr Fawzi, Mohsen Abdu (Egypt)
Electrical Engineers, Hamza Associates
Electrical Engineer: Ibrahim Helal (Egypt)
Management, Cost Consultant, Architectural Specifications, Quantity Surveying, Schumann Smith Ltd.
Principals: Nick Schumann, David Smith (UK)
QS and specifications: Pete Claridge, Keith Hands, Martin Skillings (UK)
Project Planner: Chris Glasier (UK/Hong Kong)
Lighting design: Lichtdesign Koein (Germany)
Acoustics: Multiconsult (Norway)
Fire Life Safety Design: Warrington Fire Research (UK)
Security design: Stewart Helms (UK)
Furniture Design: Snøhetta a.s. (Norway)
Project Manager: Ole Gustavsen (Norway)
Furniture and Interior Designers: Linda Evensen, Rolf Schmidt, Inger Anita Reigstad, Knut Tronstad (Norway)

Construction Supervision Phase, 1995

Architects and Engineers: Snøhetta/Hamza Consortium(Norway/Egypt)
Resident Engineer: Hamza Associates - Mamdouh Hamza (Egypt)
Engineer's Representatives: Hamza Associates: Nasry Fawzi, Moustafa Sabry, Tarek Yassin (Egypt), John Cockcroft (UK)
Project Architect, Snøhetta a.s.: Christoph Kapeller (Austria)
Senior Site Architect, Snøhetta a.s.: Peter Hall (UK)
Site Architects: Hamza Associates: Hazem Hafez, Tamer Safei Eldin, Yasser Helmi, Khaled Saad, Hossam El Suefi, Hasan Tork, Walid Mohamed Gaber
Architects, Snøhetta a.s.: Craig Dykers, USA), Robert Greenwood (UK), Ole Gustavsen (Norway), Tarald Lundevall (Norway), Kjetil Trædal Thorsen (Norway)
Fine Arts, Snøhetta a.s.: Jorunn Sannes, Kristian Blystad
Landscape Architect, Snøhetta a.s., Kari Stensrød
Mechanical Site Engineer: Hamza Associates: Mohamed Hamdi, HEND Mohamed Ahmed Abdel Rahman, Youssef Mohamed, Ahmed Abou Elwafa, Moustafa Mekky (Egypt)
Electrical Site Engineers, Hamza Associates: Sobhy El Gamel, Ahmed Farid, Moustafa Mile, Mahmoud Sobhy, Wafaa Mohamed, Doha el Gerzawy (Egypt)
Structural Site Engineers, Hamza Associates: Hany Haroun, Ashraf Roushdi, Walid Hamed (Egypt)

Contractors

Joint Venture Partners for Tender Package 1 (Foundation Works): Rodio/Trevi (Italy), Carlo Crespi, Project Manager

Joint Venture Partner for Tender Packages 2-3 (Superstructure/Finishes): Balfour Beatty (UK) – Jack Thomson, Project Manger

Joint Venture Partner for Tender Packages 1,2,3 (all works): Arab Contractors, Sayed Farouk, Deputy Project Manager

Sub-Contractors

Roof and Glazing

Gig Fassadenbau (Austria)

Amerya Metal Company (Egypt)

Stone Works

Granita (Egypt)

Haz (Turkey)

Precast Concrete Panels

Laubeuf (France)

Furnishings and Interior Partitions

Mobica (Egypt)

Bosvik (Norway)

Specialized Furnishings - Multi-M Group (Egypt); Mobica (Egypt)

Builder

Tender Package 1: Foundations and Ground Engineering

Phase 1 included the world's largest circular diaphragm wall, and double bell bottomed piles and finished in July 1996. Phase 1A included raft slab foundations and insulating concrete layer, completed in December 1996.

Rodio/Trevi(Italy)/Arab Contractors (Egypt) Joint Venture

Project Director: Carlo Crespi (Italy), Deputy Project Director Sayed Farouk (Egypt)

Tender Packages 2/3: Superstructure, HVAC, Finishes, Landscape

Phase 2 works included insitu concrete waffle slab construction, solid suspended concrete slabs, glazed aluminum roofing, gutters, and stainless steel cappings, external granite cladding with hand carved alphabetic symbols, split faced, glazed curtain walling, precast concrete wall paneling, and granite on internal floors and walls. Completed 31 March 2001.

Balfour Beatty (UK)/Arab Contractors (Egypt) Joint Venture

Project Director (Balfour Beatty): Jack Thomson (Scotland)

Deputy Project Director (Arab Contractors): Sayed Farouk (Egypt)
Chief Engineer (Balfour Beatty): Ian Wilson (Scotland)
Construction Manager (Balfour Beatty): David Wilson (UK)
Architectural Manager: Simon Baker

Specialist Contractors

Roof and Curtain Walling: GIG/Amreya (Austria/Egypt)
Granite Wall and Stone Works: Granita/Haz (Egypt/Turkey)
Planetarium Structure and Envelope: Labeuf (France)
Internal Partition and Wall Cladding: Mobica (Egypt)
Custom Furnishings: Bosvik (Norway)

Photographers

Snøhetta a.s.: Gerald Zugmann
Balfour Beatty: James Willis
Byggekunst: Nils Petter Dale
Arab Contractors: Ibrahim Nafie (Egypt)

Others include:

Helene Binet (London)
Rob Howard (New York)
Alessandro Scotti (Italy)
John Samples (Egypt)

Editors : Laila Dowidar, Cherine El Taraboulsy

Reviewer: Yehia Halim Zaki

Photography: Nils Petter Dale, Gerald Zugman, Ibrahim Nafie, Erling Bergan

Design and Layout: Mohamed Gomaa

Printer: Blankdot



BIOGRAPHY

EDUCATION

Born and raised in Alexandria, Egypt, Dr. Zahran received his B. Sc. in Architecture *cum laude* at Ein Shams university in Cairo in 1958.

He continued his education in the United States, receiving a master's degree in Architecture and Urban Designs from Massachusetts Institute of Technology (MIT) in Cambridge in 1961, a master's degree in Fine Arts from Princeton University in 1963, and finally a Ph.D. in Environmental Planning from Princeton University in 1965.

He also received a TB[[certificate for remarkable engineering studies there, the following year he became a fellow for the Salzburg Seminars (1981); and a Fullbright fellow (1986).

PROFESSIONAL EXPERIENCE

Dr. Zahran was appointed at Alexandria University, Faculty of Engineering, Department of Architecture, in 1965, and is now Emeritus professor.

He was head of department from 1994 to 1998. Dr. Zahran was seconded professor at Beirut Arab University and became Dean of the Faculty of Architecture at Beirut Arab University (1978-1982).

Dr. Zahran has been active in the comprehensive planning and urban development of a greater Alexandria. He was Chairman of the Urban Planning Commission of the Governorate from 1983 to 2000, and responsible of the comprehensive Master Plan for Alexandria 2005, and supervised its updating to 2017. He was also responsible for the design and supervision of the execution of the Alexandria International Gardens.

At the international professional level, Dr. Zahran has contributed to many international projects as an Expert and Consultant, especially to various United Nations organs like UNESCO, UNDP, UNEP, UNCHS , UNICEF, ECUA, ESCWA, UNCHBP. His work has earned him many international and local prizes. Besides this, he has also been a member of many international and local juries for architectural and urban development competitions. He has authored many books on architecture and urban planning in both Arabic and English.

Dr. Zahran has received many national and international awards in honor of his achievements, including the Medal of Distinction of the First Order from Egypt for his work on Alexandria Planning, as well as the French "Legion d'Honneur" for his work on the Bibliotheca Alexandrina Project. He is a member of several professional and civic associations.

As advisor to the president of Alexandria University for the revival of the Ancient Library of Alexandria Project Dr. Zahran was chosen as Rapporteur of the Preparatory Committee for the establishment of the Project at the University. He served on the Committee for the preparation of the Architectural Brief for the International Competition for the Design of the Library. He served as Deputy Chairman of the International Jury for the International Competition for the Architectural Design of the new Bibliotheca Alexandrina .

He was appointed as Executive Director of the General Organization for the Alexandria Library (GOAL) in February 1989, according to presidential Decree 523/88, which established the General Organization of the Alexandria Library. In 1992, Dr. Zahran was appointed Deputy Project Manager for the Bibliotheca Alexandria Project, to represent the Egyptian Government in the Project execution and implementation. In June 1995, he became the acting Project Manager upon the retirement of the Project Manager appointed by UNESCO, thus carrying out the full duties of two positions. He helped in the organization of international meeting, especially for the first meeting of the international Commission at Aswan on 12 February 1990.

During his tenure as Deputy Project Manager, and then Project Manager, he represented the Owner in the preparation for the execution for the award of the contracts for the Design and Engineering of the building, as well as in the Preparations for and the Decision Making Committee for the Tender Actions for Phase # 1 and Phase # 2 construction activities. His work including overseeing and monitoring the execution for the contracts, making sure the Contract Conditions were honored, the payment of invoices are made on time, and that progress was maintained according to the time schedule. He reported all implementation activities regularly to the Follow-up Committee appointed by the Minister for this purpose.

He has also overseen the library services, including the building up of the collections, contacts with organizations, institutions in Egypt and abroad. He has ensured that the training of the librarians and

other human resources are carried out in parallel at international standards through in-house training and abroad through scholarships, visits, and internships. He has negotiated with many governments, organizations and institutions for the support of the library building, the new Information System, the Science Museum, the Planetarium, the Archaeological Museum, Calligraphy Museum. Consequently, he concluded 24 protocols on behalf of the Library, which provide financial and in-kind support for the Project, such as books, training, expertise and equipment. The total international financial support raised with his effort has amounted to about US\$ 31.5 million. He has also helped the creation of Friends of the Bibliotheca Alexandrina in eighteen countries, and followed up their activities and support of the Project through participation in their annual meeting and encouragement to maximize their efforts in support of the Project.

He has been Editor in Chief of all Bibliotheca Alexandrina publications, including a quarterly newsletter and many publicity materials in three languages since 1990, as well as well eleven other books about conservation of the rare works and manuscripts in Alexandria in addition he was:

- Member of the Engineering Faculty Council, Alexandria University, 2003/4.
- Member of the Urban Planning Committee of the National Academy of Scientific Research and Technology, 2004/5.
- Chairman of the International Jury for the architectural Competition for the Urban Design of the new center for the City of Jeddah, Saudi Arabia, 2004.
- Referenced in the International Encyclopedias: Who's Who in the World, Who's Who in Engineering, Who's Who in Science and Technology, Who's Who in the Arab World,....
- Elected as Fellow of the American Biographical Institute (ABI).
- Awarded the ABI Certificate of Merit. Certificate of Achievement.
- Selected as one of 5000 world Great Achievers, by the ABI.



INDEX

A

Abdel Aziz, Prince Turki Bin, 32, 52, 63, 72, 160
Abdel Fattah, Said, 44, 92, 145, 161, 162
Abdel Meguid, Esmat, 30, 88, 144, 184
Abdel Zahar, Fawzi, 162, 185
Abdelhady, Layla, 56, 81
Abou Khadr, Abdel Aziz, 24, 29
Africa, 10, 13, 17, 59, 70, 121, 140, 142, 145, 147, 149, 152, 190
Aga Khan, 9, 79, 136, 138, 147, 191
Al Ahram, 24, 29, 59, 84, 85, 185
Alexander, 16, 17, 23, 32
Alexander the Great, 13, 16, 17, 22, 23, 32, 72, 87, 122, 135, 145, 178, 210, 214, 216
Alexandria, 1, 3, 4, 6, 9, 10, 11, 12, 13, 14, 16, 17, 18, 19, 20, 21, 22, 23, 24, 25, 27, 28, 29, 31, 32, 33, 34, 35, 36, 37, 38, 39, 40, 43, 44, 45, 46, 47, 48, 49, 50, 51, 52, 53, 55, 56, 58, 59, 60, 61, 63, 64, 65, 66, 67, 69, 70, 71, 72, 76, 79, 81, 82, 83, 85, 86, 88, 89, 90, 92, 93, 94, 95, 96, 97, 98, 99, 101, 102, 104, 105, 108, 109, 110, 111, 113, 114, 115, 116, 120, 122, 125, 127, 128, 129, 130, 131, 132, 133, 134, 135, 136, 137, 138, 140, 141, 142, 144, 145, 146, 147, 148, 149, 151, 152, 153, 154, 155, 156, 157, 158, 159, 160, 161, 162, 168, 169, 170, 171, 172, 173, 174, 175, 176, 177, 178, 179, 181, 183, 185, 189, 196, 197, 198, 199, 200, 201, 203, 204, 206, 210, 211, 212, 213, 214, 215, 216, 217, 218, 219, 225, 226
Alexandria Friends, 92, 144, 145, 176
Alexandria Mediterranean Research Center, 110, 170
Ali, Fathy Mohamed, 29, 170, 172, 176, 187

Aman, Mohammed, 30, 38, 55, 96, 107, 149, 167, 187
Ancient Library, 1, 3, 6, 9, 13, 16, 17, 19, 20, 22, 23, 24, 27, 50, 51, 87, 98, 107, 113, 114, 127, 154, 155, 157, 158, 159, 160, 172, 178, 189, 196, 198, 200, 201, 213, 216
Antiquities, 31, 64, 65, 85, 87, 94, 101, 108, 109, 111, 133, 135, 167, 181, 192, 197, 217
Arabs, 13, 20, 25, 26, 34, 46, 144, 195, 196, 210, 216
Archaeological investigations, 65, 109, 111, 165, 167, 179, 214
Aris Zavarakis, 189
Aswan, 12, 17, 27, 28, 30, 31, 32, 46, 49, 50, 51, 52, 53, 55, 56, 64, 70, 71, 72, 73, 74, 75, 77, 80, 84, 86, 92, 96, 109, 115, 117, 126, 127, 130, 132, 134, 144, 148, 149, 151, 153, 155, 157, 167, 168, 179, 185, 186, 189, 196
Aswan Declaration, 30, 32, 35, 51, 53, 71, 72, 74, 75, 84, 86, 179
Australia, 19, 42, 60, 89, 116, 121, 125, 145, 185, 190
Awards, 136, 191, 204

B

Bahaa El Din, Hussein Kamel, 29, 35, 48, 162, 176
Balfour Beatty/Arab Contractors, 4, 6, 36, 70, 115, 118, 119, 180, 187, 197
Baltimore, 93, 97, 145, 212
Baltimore Friends, 93, 145
Bibliotheca Alexandrina, 4, 6, 7, 9, 10, 11, 12, 13, 14, 15, 16, 17, 18, 19, 21, 22, 23, 24, 25, 26, 27, 28, 29, 31, 32, 33, 36, 38, 43, 45, 47, 49, 50, 51, 52, 54, 55, 57, 58, 59, 60, 63, 64, 71, 72, 73, 78, 79, 81, 82, 83, 85, 86, 87, 89, 90, 91, 92, 93,

94, 96, 97, 98, 100, 101, 102, 103, 104, 105, 106, 107, 109, 110, 113, 114, 115, 116, 117, 118, 120, 121, 122, 125, 126, 127, 128, 129, 130, 131, 132, 134, 135, 136, 137, 138, 140, 141, 142, 144, 145, 147, 148, 149, 151, 152, 155, 156, 157, 158, 159, 160, 161, 162, 163, 170, 172, 175, 176, 177, 178, 180, 182, 184, 185, 186, 188, 189, 192, 196, 197, 198, 199, 200, 203, 211, 219, 225, 226

Bookfairs, 59, 85, 117

British Council, 31, 60, 86, 141, 160, 161, 176, 187

British Library, 37, 96, 102, 103, 131, 167, 218

Bulgaria, 145

C

California Friends, 146

Calligraphy, 48, 167

Callimachus, 17, 18, 23, 24, 145, 178, 183, 211, 217, 219

Canada, 6, 31, 85, 93, 104, 121, 131, 141, 146, 163, 177, 180, 185, 190

Cavafy, 189

civilization, 17, 99, 102, 103, 143, 157, 174, 175, 179, 197

Clavel, Jean Pierre, 37, 38, 54, 55, 165

Cleopatra, 19, 25, 32, 33, 122, 178, 182

Conference Center, 24, 28, 29, 31, 32, 34, 38, 39, 40, 42, 44, 45, 47, 49, 54, 55, 56, 58, 59, 60, 63, 71, 75, 79, 81, 82, 83, 85, 86, 87, 96, 100, 107, 109, 110, 115, 123, 125, 126, 128, 132, 133, 141, 168, 169, 183, 185, 186, 192, 196, 203

Conservation Laboratory, 36, 85, 105, 143, 160, 161, 163, 166, 168

Construction Monitoring Unit, 57, 60, 80, 81, 86, 133, 134, 143, 172, 186, 225

Contributions, 139, 141, 188, 248, 249, 250, 251, 252

Council of Patrons, 116, 206

D

Dahlstrom, Annica, 190

Delaygue, Michelle, 146

Demetrius of Phaleron, 17, 23, 24, 178

Denmark, 141

Destruction, 19, 25, 33, 210, 217

Diaphragm Wall, 73, 122, 123, 193

Director General, 24, 25, 26, 27, 28, 29, 30, 32, 43, 47, 73

Dowidar, Laila, 4, 56, 81, 131, 186, 225

Dowidar, Loutfy, 23, 24, 27, 28, 29, 30, 45, 92, 161

Dykers, Craig, 51, 132, 186, 225

E

Egyptian Antiquities Organization, 13, 64, 65, 108, 109, 197

Egyptian Friends, 144

El Abbadi, Mostafa, 9, 19, 22, 23, 24, 25, 27, 28, 172, 213

El Hadary, Mahmoud, 23, 24, 27

El Henaidy, Ali Reda, 23, 27

El Khatib, Fathallah, 24, 28, 43, 58, 69, 161, 170, 176

El Mahgoub, General Mohamed Abdel, 49, 130, 173, 185

El Turgoman, Mohamed, 56, 131

Elabd, Abdelwahab, 145

Escorial, 148

Executive Director, 13, 42, 49, 55, 74, 79, 80, 90, 112, 273

Executive Secretariat, 28, 30, 35, 36, 45, 55, 56, 67, 69, 70, 77, 80, 81, 84, 86, 87, 113, 115, 116, 118, 126, 128, 130, 131, 137, 160, 162, 183, 186, 197, 225

F

Faculty of Engineering, 22, 56, 134, 160, 161, 170, 171, 172, 174

Fouad, Neemat Ahmed, 145, 189
France, 20, 28, 29, 31, 32, 38, 51, 53, 82, 83, 85, 86, 94, 97, 104, 116, 120, 131, 136, 142, 146, 153, 162, 163, 164, 165, 168, 169, 176, 180, 185, 190, 191, 225
Frankfurt, 84
French Friends, 38, 94, 136, 146, 162, 190, 191
French National Library, 86, 88, 102, 103, 131, 142, 175, 177, 190, 191
Funds in Trust, 38, 63, 105, 107, 127, 161, 185, 186, 194
Furniture, 35, 42, 88, 135, 143, 144, 166, 180, 186, 188, 252

G

Geh, Hans-Peter, 52, 72, 165, 168
General Organization of the Alexandria Library, 6, 9, 10, 12, 13, 28, 30, 33, 34, 35, 38, 43, 48, 49, 53, 55, 56, 57, 58, 59, 60, 64, 66, 67, 74, 77, 78, 79, 80, 81, 83, 84, 85, 86, 87, 88, 90, 92, 97, 104, 105, 108, 109, 112, 115, 122, 125, 126, 128, 130, 131, 133, 134, 135, 137, 144, 160, 161, 162, 176, 179, 183, 186, 187, 189, 196, 198, 199, 200, 215, 225, 273
German Friends, 38, 94, 147, 160, 161, 180
Germany, 28, 29, 31, 32, 37, 39, 43, 55, 82, 83, 85, 86, 104, 132, 147, 157, 160, 161, 162, 163, 165, 168, 176, 177, 180, 185, 186, 191, 225
Governor of Alexandria, 32, 49, 83, 161, 185, 187, 200, 206
Greco-Roman, 13, 21, 22, 23, 65, 108, 122, 152, 171, 172, 173, 178, 179
Greece, 13, 17, 18, 19, 20, 23, 32, 36, 38, 59, 66, 87, 91, 97, 101, 109, 135, 136, 143, 144, 145, 147, 149, 150, 151, 152, 155, 158, 160, 161, 162, 165, 180, 181, 186, 189, 190, 198, 199, 212, 214, 215, 216, 217, 218, 219, 220
Greek Friends, 87, 135, 147, 150, 161, 186, 190
Grunberg, Gerald, 86, 105, 136, 142, 160, 191

H

Hall of Fame, 177, 178
Hamza Associates, 4, 6, 71, 74, 132, 225
Hamza, Mamdouh, 4, 6, 64, 66, 67, 71, 74, 97, 107, 110, 111, 112, 115, 132, 134, 186, 187, 225
Helal, Ahmed, 39, 40, 55, 56, 57, 165, 177
Helmi, Fouad, 5, 22, 23, 26, 174
Hoem, Bodil, 148
Holmquist, Richard, 127, 136, 167, 177, 184
Hussein, Taha, 21, 26, 85, 106, 125, 192
Hypatia, 20, 26, 34, 122, 178, 183, 212

I

IFLA, 52, 72, 160, 168
Inauguration, 31, 34, 60, 61, 65, 87, 93, 94, 96, 97, 115, 116, 119, 120, 175, 181, 186
International Commission, 4, 9, 28, 30, 32, 33, 35, 43, 45, 47, 49, 50, 51, 55, 56, 80, 81, 84, 96, 120, 127, 134, 140, 154, 155, 157, 159, 160, 175, 179, 186, 196, 214
International Executive Committee, 25, 28, 30, 35, 43, 45, 47, 56, 57, 58, 69, 80, 81, 82, 83, 84, 104, 115, 128, 130, 144, 160, 162, 168, 170, 176, 179, 216
International Friends, 4, 6, 31, 36, 37, 38, 39, 57, 61, 81, 85, 96, 97, 119, 127, 136, 144, 145, 146, 147, 148, 149, 150, 152, 180, 181
International Union of Architects, 9, 25, 30, 32, 35, 36, 37, 38, 40, 46, 53, 54, 57, 63, 83, 114, 129, 177, 186
Iraq Contributions, 53, 73, 140, 185, 186, 190
ISIS, 29, 38, 44, 45, 54, 57, 58, 82, 96, 97, 105, 107, 163, 164, 167, 186, 203
Italy, 31, 32, 38, 41, 43, 58, 60, 61, 74, 94, 104, 131, 147, 160, 161, 162, 165, 166, 169, 180, 186, 190, 216, 225

- K**
 King Farouk University, 26, 34, 125, 179, 196
 Kuwait, 53, 120, 121, 160, 176, 185, 190
- L**
 Legal Framework, 273, 274, 275, 276, 277, 278, 279, 280, 281, 282, 283
 Leroy, Jacqueline, 86, 94, 105, 136, 146, 160, 163, 190
 Lighthouse, 17, 24, 111, 178
- M**
 Matura, Kochira, 127, 167, 183, 184
 Mayor, Federico, 25, 26, 29, 30, 32, 40, 45, 46, 52, 73, 83, 84, 114, 127, 145, 148, 162, 167, 179, 180, 200, 210
 Mediterranean, 6, 10, 12, 13, 16, 18, 24, 41, 43, 59, 66, 69, 71, 72, 91, 95, 97, 101, 102, 110, 111, 113, 114, 121, 141, 149, 151, 155, 157, 170, 186, 198, 204, 214
 Mexico, 37, 38, 95, 147, 177, 180, 186, 191
 Middle East, 10, 12, 13, 17, 70, 79, 101, 107, 121, 140, 142, 147, 149, 152, 155, 158, 198, 199, 204
 Milopoulou, Anastasia, 189, 190
 Minister of Education, 19, 24, 25, 32, 33, 35, 44, 46, 48, 52, 55, 56, 58, 92, 113, 119, 127, 133, 145, 160, 162, 176, 184, 198, 199, 200, 201
 Ministry of Culture, 31, 33, 65, 85, 109, 161, 186
 Mitterand, Françoise, 46, 72, 141, 176
 Monaco, 46, 52, 90, 160, 190
 Mostafa, Fareed, 23, 24, 28, 125, 172, 174, 176, 183
 Mubarak, Hosni, 4, 7, 9, 10, 11, 12, 13, 17, 24, 25, 29, 30, 32, 33, 34, 45, 47, 50, 51, 52, 70, 71, 73, 81, 83, 101, 114, 115, 126, 127, 134, 140, 144, 148, 151, 153, 157, 158, 179, 181, 183, 196, 202, 205, 208
 Mubarak, Suzanne, 4, 6, 9, 10, 13, 25, 29, 30, 32, 33, 35, 45, 46, 48, 49, 50, 51, 56, 58, 68, 70, 71, 73, 80, 81, 83, 84, 93, 94, 95, 97, 98, 103, 106, 114, 115, 116, 119, 120, 121, 126, 134, 140, 142, 144, 151, 153, 154, 155, 159, 166, 175, 176, 179, 181, 183, 187, 188, 197, 208,
 Museion, 16, 18, 23, 26, 103, 106, 107, 159
 Museum, 21, 23, 64, 65, 71, 85, 86, 87, 94, 96, 107, 108, 109, 113, 122, 132, 133, 135, 136, 157, 163, 165, 172, 181, 185, 186, 192, 203, 211, 214, 216
- N**
 Nobel Section, 95, 190
 Norway, 35, 40, 42, 52, 63, 72, 78, 89, 90, 96, 132, 135, 143, 160, 162, 166, 177, 180, 186, 191, 225
 Norwegian Friends, 136, 148, 149
 Oman, 52, 53, 72, 159, 160, 162, 185, 186
 Osman, Ali, 56, 70, 81, 163, 177
- P**
 Paideia, 13, 17
 Pharos, 13, 18, 24, 66, 109, 151
 Phase I, 4, 33, 35, 36, 57, 58, 67, 68, 69, 70, 71, 76, 113, 114, 115, 116, 118, 120, 121, 122, 123, 124, 125, 126, 127, 128, 129, 133, 134, 197, 225
 Phase II, 4, 33, 35, 36, 58, 67, 68, 70, 71, 113, 115, 117, 118, 119, 129, 130, 131, 132, 133, 134, 197, 225
 Planetarium, 48, 60, 71, 78, 86, 95, 99, 107, 108, 110, 120, 132, 133, 135, 137, 165, 166, 169, 192, 193, 195, 203, 225
 Plaza, 72, 87, 99, 102, 103, 107, 109, 120, 133, 171, 175, 190, 192, 194
 Preliminary Design Review, 35, 46, 47, 48, 63, 65, 66, 67, 90, 91, 107, 186, 132, 217, 225
 Preparatory Committee, 24, 28, 29, 32, 34, 37, 55, 59, 83, 85, 110, 113, 114, 122, 125, 126, 131, 179, 196

Project Agreement, 30, 35, 55, 56, 84, 86, 87, 112, 113, 127, 128, 179, 196, 197

Project Manager, 6, 9, 10, 13, 30, 35, 36, 56, 58, 67, 69, 86, 115, 116, 125, 128, 130, 136, 162, 163, 177, 179, 186, 225

Ptolemies, 12, 13, 16, 17, 19, 23, 25, 32, 65, 109, 151, 157, 169, 178, 210, 212, 213, 214

Ptolemy I Soter, 13, 16, 17, 18, 23, 32, 109, 122, 133, 168, 178, 182

Ptolemy II Philadelphus, 13, 16, 17, 18, 23, 32, 122, 178, 182

Q

Quebec, 86, 120, 131, 141, 175, 181

Queen Noor, 30, 51, 71, 72, 84, 160

Queen Sophia, 30, 71, 72, 84

R

Rare manuscripts, 49, 159, 161, 168, 185, 189, 192

Rodio/Trevi/Arab Contractors, 4, 6, 35, 36, 69, 70, 76, 115, 116, 117, 120, 121, 129, 134, 179, 187, 197, 225

Romerio, 45, 56, 58, 61, 70, 81, 87, 107, 128, 130, 162, 177, 186, 225

Roof, 72, 100, 101, 130, 131, 135, 192, 195, 225

S

Sannes, Jorunn, 77, 132, 134, 186, 225

Saudi Arabia, 32, 53, 72, 73, 160, 162, 176, 185, 186, 190

Science Museum, 38, 71, 86, 107, 108, 164, 166, 168, 172, 181, 185, 192, 203

Seat Agreement, 30, 35, 46, 56, 57, 82, 83, 84, 115, 179, 196, 197

Selsela, 22, 24, 25, 71, 75, 105, 107, 110, 114, 115, 132, 179, 196

Septuagint, 13, 18, 178

Serageldin, Ismail, 4, 7, 9, 13, 79, 115, 131, 136

Shatby, 22, 24, 56, 130, 131, 132, 179, 196, 197, 226

Shehab, Moufid, 33, 55, 63, 79, 107, 129, 162, 167

Sirenelli, Jean, 94

Snøhetta a.s, 4, 6, 39, 40, 42, 46, 58, 59, 60, 63, 64, 65, 66, 67, 68, 71, 74, 87, 95, 97, 107, 110, 111, 114, 115, 127, 132, 134, 148, 179, 186, 187, 217, 225

Sorour, Fathy, 24, 29, 33, 44, 46, 55, 126, 127, 128, 158, 161, 184

Spain, 31, 35, 36, 39, 46, 51, 85, 86, 104, 109, 140, 160, 161, 166, 168, 177, 180, 181, 186, 190, 213

Spanish Friends, 136, 148, 149, 160, 161

Stone Wall, 134, 135, 136, 138

Sunken monuments, 47, 135

Sweden, 95, 135, 186, 190, 191

Swedish Friends, 95, 136, 148

Syria, 53, 137

T

Thorsen, Kjetil, 39, 51, 56, 71, 97, 132, 135, 166, 186, 187, 225

Turkey, 37, 120, 140, 162, 166, 176, 180, 186, 191, 215, 218, 225

U

UK Friends, 96, 97, 149, 210

UNDP, 6, 9, 12, 25, 28, 30, 32, 34, 36, 37, 43, 44, 45, 52, 53, 57, 58, 81, 82, 83, 104, 105, 114, 116, 119, 127, 129, 140, 160, 161, 162, 166, 177, 179, 187, 189, 219

UNESCO, 6, 8, 9, 12, 14, 17, 23, 24, 25, 26, 27, 28, 29, 30, 31, 32, 33, 34, 36, 37, 38, 39, 40, 42, 43, 44, 45, 46, 47, 50, 52, 53, 54, 55, 56, 57, 58, 59, 61, 63, 64, 67, 69, 72, 78, 79,

80, 81, 82, 83, 84, 85, 87, 88, 92, 93, 94, 95, 96, 97, 101, 102, 103, 104, 105, 108, 114, 115, 116, 119, 120, 125, 126, 127, 128, 129, 130, 131, 132, 133, 134, 136, 140, 144, 145, 151, 152, 154, 156, 157, 158, 159, 160, 161, 162, 163, 167, 168, 169, 170, 172, 175, 176, 177, 179, 180, 183, 184, 185, 186, 187, 188, 189, 196, 202, 206, 210, 213, 216, 217, 219

United Arab Emirates, 71, 72, 73, 120, 176, 187

University of Alexandria, 4, 6, 21, 22, 24, 25, 26, 27, 29, 30, 32, 33, 34, 46, 47, 49, 55, 56, 64, 78, 79, 82, 83, 92, 111, 113, 114, 125, 126, 128, 131, 133, 135, 144, 152, 158, 161, 171, 173, 175, 176, 179, 189, 196, 201, 206, 219

University of Cairo, 104, 161

USA, 6, 22, 28, 29, 31, 38, 43, 70, 82, 83, 85, 89, 90, 93, 96, 97, 104, 121, 122, 132, 146, 147, 167, 168, 169, 176, 180, 187, 191, 225

W

Wardrop, David, 149

Warneke, John, 50, 55, 56, 63

Wisconsin, 96, 107, 120, 136, 211

Z

Zahran, Mohsen, 9, 13, 28, 29, 30, 45, 76, 141, 145, 186, 191,







2007